



Geethanjali

Phone : 9533791618
Fax : +91-40-24220320
Website: www.geethanjalinstitutions.com
info@gcet.edu.in

Geethanjali College of Engineering and Technology

AUTONOMOUS

(Accredited by NBA, Approved by AICTE, New Delhi)

Sy.No. 33 & 34, Cheeryal (V), Keesara (M), Medchal District. - 501 301.

GEETHANJALI CUBE OPEN 2018

Letter of Appreciation

We appreciate the exemplary efforts of **Ms. Rukmini Varalakshmi (Mech-1B)** as volunteer of the event "**GEETHANJALI CUBE OPEN 2018**" organized in association with "**World cube Association & Deccan Cubing**" on 21st January 2018.

Faculty Coordinators

Principal
PRINCIPAL
Geethanjali College of Engg. and Tech.
Cheeryal (V), Keesara (M), Medchal Dist.(T.S.)-501 301.





PRINCIPAL
Geethanjali College of Engg. Tech.
Cheeryal (V), Keesara (M), R.R. Dist. (A.P.) - 501 301

Sponsored by **TEJA EDUCATIONAL SOCIETY, HYDERABAD**

Office : Sy. No. 33 & 34, Cheeryal (V), Keesara (M), Medchal Dist. - 501 301.

Phones : 9533791618, 7306295152



Geethanjali

Phone : 9533791618
Fax : +91-40-24220320
Website: www.geethanjalinstitutions.com
info@gcet.edu.in

Geethanjali College of Engineering and Technology

AUTONOMOUS

(Accredited by NBA, Approved by AICTE, New Delhi)

Sy.No. 33 & 34, Cheeryal (V), Keesara (M), Medchal District. - 501 301.

GEETHANJALI CUBE OPEN 2018

Letter of Appreciation

We appreciate the exemplary efforts of **Mr. Vyshnav (CE-2B)** for coverage of the event “**GEETHANJALI CUBE OPEN 2018**” organized in association with “**World cube Association & Deccan Cubing**” on 21st January 2018.

Faculty Coordinators

Principal
PRINCIPAL
Geethanjali College of Engg. and Tech.
Cheeryal (V), Keesara (M), Medchal Dist.(T.S.)-501 301.



PRINCIPAL
Geethanjali College of Engg. Tech.
Cheeryal (V), Keesara (M), R.R. Dist. (A.P.) - 501 301

Sponsored by **TEJA EDUCATIONAL SOCIETY, HYDERABAD**

Office : Sy. No. 33 & 34, Cheeryal (V), Keesara (M), Medchal Dist. - 501 301.

Phones : 9533791618, 7306295152

Geethanjali Cube Open 2018 List of Participants				Date	21-01-2018
S.No	Event	Roll No	Name	Branch	Date
1	GEETHANJALI CUBE OPEN 2018	15R11A05K3	D.V.N. Ramya Samhitha	CSE 3D	21-01-2018
2		15RR1A05M2	M. Harshini	CSE 3D	
3		16R11A05A9	K.N.V. Ramana	CSE 2C	
4		15R11A05N5	R. Shivani	CSE 3D	
5		15R11A05N9	P. Swathi	CSE 3D	
6		16R11A05F4	A. Ananya Rao	CSE 2D	
7		16R11A05H0	Anjali Rao. T	CSE 2D	
8		16R11A05J3	J. Mahitha	CSE 2D	
9		15R11A0479	J. S. V. Tarun	ECE 3B	
10			Savitha Vaishnavi	ECE 2A	
11			A. Anoohya Rao	ECE 2A	
12			B. Tualsi	ECE 2B	
13			C.V.S.B. Bharadwaja	MECH 3A	
14			Naga Jayanth	MECH 2B	
15			P. Sucharitha	MECH 2B	
16			Rukmini Varalakshmi	MECH 1B	
17			Vaishnav	CE 2B	
18			Manish K	CE 1B	

PRINCIPAL
 Geethanjali College of Engg. Techn.
 Cheeryal (V), Keesara (M), R.R. Dist. (A.P.) - 501 303

CALLING ALL SPEEDCUBERS

Fastest fingers first

**PAVAN KUMAR AKULA
TELLS US WHAT IT
TAKES TO MASTER
THE RUBIK'S CUBE**



KOTA SAUNYA

Most of us, at some point in our life, would have tried to solve a Rubik's Cube. And, many may have given up trying to find a solution to the seemingly unsolvable scramble. But, there is that small segment of individuals made of a 'genetically superior' material who can make sense of this

These superior beings are called speedcubers, and Pavan Kumar Akula is one such speedcuber right here in the city. The 25-year-old has been around the cubing block for quite some time now, who has seriously started cubing in 2010 and won several competitions and awards.

World champion

However, things took a definite U-turn when he became World Champion in 2012 by 3' speedcubing competition with a 100 per cent success ratio in blind-folded category in 2012. Besides him, only two other individuals to achieve that feat at the time were Tim Habermass from Germany and Mats Bergsten from Sweden.

After that, this BTEch graduate

from the Mahatma Gandhi Institute of Technology started watching YouTube videos and learning the different techniques involved. Mastering the techniques was not an easy process and it took hours of practice spread over days.

So begins the journey...

His world title also got him the attention of World Cube Association (WCA), the governing body of Rubik's Cube competitions which gave him the designation of a delegate. And, so began his journey into the world of cubes. Interestingly, there are only five such speedcubers in India who are recognised by WCA.

In Hyderabad, Pavan runs Decan Cubing, an association he started in August 2017 for Rubik's Cube aficionados like him. Now, he, along with a six-member core team, conducts workshops and competitions in private institutes and schools teaching students as young as six.

"For children

below six, we start them off easy with a pyramid puzzle and for others, we tell them about the cube as a concept and give them a 3 by 3 cube to solve. We also tell them about the importance of solving it more than crushing against time," explains Pavan who has also won a place in the Limca Book of Records for making 'the largest cube mosaic of Bhagat Singh' with the help of 8,000 Rubik's Cubes in 2013.

Multi-layered tests

Categories are aplenty in this field, like working a 2x2, 4x4, 6x6, 7x7, one-handed solve, fewest moves, multi-blind and other shapes such as the megaminx and pyraminx. These not only test a person's cognitive thinking, but also spatial intelligence, decision-making and analytical skills, apart from short-term and long-term memory.

Not content to do routine stuff, Pavan also attempted a Guinness World Record in 2016 by solving the cube while hanging upside down in 30 seconds. He managed that in 1748 seconds. He does admit that there is a growing number of cube solvers in the city, but many are unaware about the competitive side to it. "We are now preparing to take part in the Indian Nationals in Mumbai which will be held on May 25," adds Pavan.

Geethanjali Cheeryal (V), K...
g. Teo...
(A.P.) 50130





PRINCIPAL
Geethanjali College of Engg. Tech.
Cheeryal (V), Keesara (M), R.R. Dist. (A.P.) - 501 301



Geethanjali

Phone : 9533791618
Fax : +91-40-24220320
Website: www.geethanjaliinstitutions.com
info@gcet.edu.in

Geethanjali College of Engineering and Technology

AUTONOMOUS

(Accredited by NBA, Approved by AICTE, New Delhi)

Sy.No. 33 & 34, Cheeryal (V), Keesara (M), Medchal District. - 501 301.

GEETHANJALI CUBE OPEN 2018

Letter of Appreciation

We appreciate the exemplary efforts of **Mr.C.V.S.B.Bharadwaja (Mech-3A)** as coordinator of the event “**GEETHANJALI CUBE OPEN 2018**” organized in association with “**World cube Association & Deccan Cubing**” on 21st January 2018.

Faculty Coordinators

Principal
PRINCIPAL
Geethanjali College of Engg. and Tech.
Cheeryal (V), Keesara (M), Medchal Dist.(T.S.)-501 301.

PRINCIPAL
Geethanjali College of Engg. Tech.
Cheeryal (V), Keesara (M), R.R. Dist. (A.P.) - 501 301

Sponsored by **TEJA EDUCATIONAL SOCIETY, HYDERABAD**

Office : Sy. No. 33 & 34, Cheeryal (V), Keesara (M), Medchal Dist. - 501 301.

Phones : 9533791618, 7306295152



Geethanjali

Phone : 9533791618
Fax : +91-40-24220320
Website: www.geethanjaliinstitutions.com
info@gcet.edu.in

Geethanjali College of Engineering and Technology

AUTONOMOUS

(Accredited by NBA, Approved by AICTE, New Delhi)

Sy.No. 33 & 34, Cheeryal (V), Keesara (M), Medchal District. - 501 301.

GEETHANJALI CUBE OPEN 2018

Letter of Appreciation

We appreciate the exemplary efforts of **Ms.D.V.N.Ramya Samhitha(CSE-3D)** as coordinator of the event "**GEETHANJALI CUBE OPEN 2018**" organized in association with "**World cube Association & Deccan Cubing**" on 21st January 2018.

Faculty Coordinators

Principal

PRINCIPAL

Geethanjali College of Engg. and Tech.
Cheeryal (V), Keesara (M), Medchal Dist.(T.S.)-501 301.

PRINCIPAL

Geethanjali College of Engg. Tech.
Cheeryal (V), Keesara (M), R.R. Dist. (A.P.) - 501 301

Sponsored by **TEJA EDUCATIONAL SOCIETY, HYDERABAD**

Office : Sy. No. 33 & 34, Cheeryal (V), Keesara (M), Medchal Dist. - 501 301.

Phones : 9533791618, 7306295152



Geethanjali

Phone : 9533791618
Fax : +91-40-24220320
Website: www.geethanjaliinstitutions.com
info@gcet.edu.in

Geethanjali College of Engineering and Technology

AUTONOMOUS

(Accredited by NBA, Approved by AICTE, New Delhi)

Sy.No. 33 & 34, Cheeryal (V), Keesara (M), Medchal District. - 501 301.

GEETHANJALI CUBE OPEN 2018

Letter of Appreciation

We appreciate the exemplary efforts of **Ms.M.Harshini (CSE-3D)** as coordinator of the event “**GEETHANJALI CUBE OPEN 2018**” organized in association with “**World cube Association & Deccan Cubing**” on 21st January 2018.

Faculty Coordinators

Principal
PRINCIPAL
Geethanjali College of Engg. and Tech.
Cheeryal (V), Keesara (M), Medchal Dist (T.S.)-501 301.

PRINCIPAL
Geethanjali College of Engg. Tech.
Cheeryal (V), Keesara (M), R.R. Dist. (A.P.) - 501 301

Sponsored by **TEJA EDUCATIONAL SOCIETY, HYDERABAD**

Office : Sy. No. 33 & 34, Cheeryal (V), Keesara (M), Medchal Dist. - 501 301.

Phones : 9533791618, 7306295152



Geethanjali

Phone : 9533791618
Fax : +91-40-24220320
Website: www.geethanjaliinstitutions.com
info@gcet.edu.in

Geethanjali College of Engineering and Technology

AUTONOMOUS

(Accredited by NBA, Approved by AICTE, New Delhi)

Sy.No. 33 & 34, Cheeryal (V), Keesara (M), Medchal District. - 501 301.

GEETHANJALI CUBE OPEN 2018

Letter of Appreciation

We appreciate the exemplary efforts of **Mr. J.S.V.Tarun (ECE-3B)** as volunteer of the event "GEETHANJALI CUBE OPEN 2018" organized in association with "World cube Association & Deccan Cubing" on 21st January 2018.

Faculty Coordinators

Principal
PRINCIPAL
Geethanjali College of Engg. and Tech.
Cheeryal (V), Keesara (M), Medchal Dist.(T.S.)-501 301.

PRINCIPAL
Geethanjali College of Engg. Tech.
Cheeryal (V), Keesara (M), R.R. Dist. (A.P.) - 501 301

Sponsored by **TEJA EDUCATIONAL SOCIETY, HYDERABAD**

Office : Sy. No. 33 & 34, Cheeryal (V), Keesara (M), Medchal Dist. - 501 301.

Phones : 9533791618, 7306295152



Geethanjali

Phone : 9533791618
Fax : +91-40-24220320
Website: www.geethanjaliinstitutions.com
info@gcet.edu.in

Geethanjali College of Engineering and Technology

AUTONOMOUS

(Accredited by NBA, Approved by AICTE, New Delhi)

Sy.No. 33 & 34, Cheeryal (V), Keesara (M), Medchal District. - 501 301.

GEETHANJALI CUBE OPEN 2018

Letter of Appreciation

We appreciate the exemplary efforts of **Mr.K.N.V.Ramana(CSE-2C)** as volunteer of the event “**GEETHANJALI CUBE OPEN 2018**” organized in association with “**World cube Association & Deccan Cubing**” on 21st January 2018.

Faculty Coordinators

Principal
PRINCIPAL
Geethanjali College of Engg. and Tech.
Cheeryal (V), Keesara (M), Medchal Dist.(T.S.)-501 301.

PRINCIPAL
Geethanjali College of Engg. Tech.
Cheeryal (V), Keesara (M), R.R. Dist. (A.P.) - 501 301

Sponsored by **TEJA EDUCATIONAL SOCIETY, HYDERABAD**

Office : Sy. No. 33 & 34, Cheeryal (V), Keesara (M), Medchal Dist. - 501 301.

Phones : 9533791618, 7306295152



Geethanjali

Phone : 9533791618
Fax : +91-40-24220320
Website : www.geethanjaliinstitutions.com
info@gcet.edu.in

Geethanjali College of Engineering and Technology

AUTONOMOUS

(Accredited by NBA, Approved by AICTE, New Delhi)
Sy.No. 33 & 34, Cheeryal (V), Keesara (M), Medchal District. - 501 301.

GEETHANJALI CUBE OPEN 2018

Letter of Appreciation

We appreciate the exemplary efforts of **Mr. Naga Jayanth(Mech-2B)** as volunteer of the event “**GEETHANJALI CUBE OPEN 2018**” organized in association with “**World cube Association & Deccan Cubing**” on 21st January 2018.

Faculty Coordinators

Principal
PRINCIPAL
Geethanjali College of Engg. and Tech.
Cheeryal (V), Keesara (M), Medchal Dist.(T.S.)-501 301.

PRINCIPAL
Geethanjali College of Engg. Techn.
Cheeryal (V), Keesara (M), R.R. Dist. (A.P.) - 501 301



Geethanjali

Phone : 9533791618
Fax : +91-40-24220320
Website: www.geethanjaliinstitutions.com
info@gcet.edu.in

Geethanjali College of Engineering and Technology

AUTONOMOUS

(Accredited by NBA, Approved by AICTE, New Delhi)

Sy.No. 33 & 34, Cheeryal (V), Keesara (M), Medchal District. - 501 301.

GEETHANJALI CUBE OPEN 2018

Letter of Appreciation

We appreciate the exemplary efforts of **Mr. Manish Kotamgari (CE-1B)** as volunteer of the event "**GEETHANJALI CUBE OPEN 2018**" organized in association with "**World cube Association & Deccan Cubing**" on 21st January 2018.

Faculty Coordinators

Principal
Geethanjali College of Engg. and Tech.
Cheeryal (V), Keesara (M), Medchal Dist. (T.S.)-501 301.

PRINCIPAL
Geethanjali College of Engg. Tech.
Cheeryal (V), Keesara (M), R.R. Dist. (A.P.) - 501 301

Sponsored by **TEJA EDUCATIONAL SOCIETY, HYDERABAD**

Office : Sy. No. 33 & 34, Cheeryal (V), Keesara (M), Medchal Dist. - 501 301.

Phones : 9533791618, 7306295152

12/02/2018.

To,

GCET Chairman,
Greethanjali College,
Keesara.

SUB: Renewal of Greethanjali App Hosting

Sir,

As our Greethanjali App's Hosting Server (i.e., GoDaddy) is going to expire in April. We request you to renew our Hosting service from GoDaddy to Hostinger as our current server responds very slowly.

Yours sincerely,

Saish (14R11A05F2)

B.Tech CSE IV-C

(9640408874)

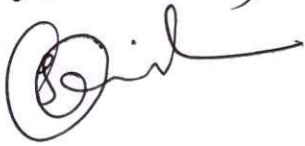

Greethanjali College of Engg. & Tech.
Cheeraj (V), Keesara (M), R.R. Dist. (A.P.) - 501 304.



Geethanjali

Phone : 9533791618
Fax : +91-40-24220320
Website: www.geethanjaliinstitutions.com
info@gcet.edu.in

Geethanjali College of Engineering and Technology

AUTONOMOUS

(Accredited by NBA, Approved by AICTE, New Delhi)

Sy.No. 33 & 34, Cheeryal (V), Keesara (M), Medchal District. - 501 301.

GEETHANJALI CUBE OPEN 2018

Letter of Appreciation

We appreciate the exemplary efforts of **Ms. Savitha Vaishnavi (ECE-2A)** as volunteer of the event **“GEETHANJALI CUBE OPEN 2018”** organized in association with **“World cube Association & Deccan Cubing”** on 21st January 2018.

Faculty Coordinators

Principal
PRINCIPAL

Geethanjali College of Engg. and Tech.
Cheeryal (V), Keesara (M), Medchal Dist.(T.S.)-501 301.

Geethanjali College of Engg. and Tech.
Cheeryal (V), Keesara (M), R.R. Dist. (A.P.) - 501 301

PRINCIPAL
Geethanjali College of Engg. and Tech.
Cheeryal (V), Keesara (M), R.R. Dist. (A.P.) - 501 301

Sponsored by **TEJA EDUCATIONAL SOCIETY, HYDERABAD**

Office : Sy. No. 33 & 34, Cheeryal (V), Keesara (M), Medchal Dist. - 501 301.

Phones : 9533791618, 7306295152



Geethanjali

Phone : 9533791618
Fax : +91-40-24220320
Website: www.geethanjaliinstitutions.com
info@gcet.edu.in

Geethanjali College of Engineering and Technology

AUTONOMOUS

(Accredited by NBA, Approved by AICTE, New Delhi)

Sy.No. 33 & 34, Cheeryal (V), Keesara (M), Medchal District. - 501 301.

GEETHANJALI CUBE OPEN 2018

Letter of Appreciation

We appreciate the exemplary efforts of **Ms. A.Anoohya Rao (ECE-2A)** as volunteer of the event **“GEETHANJALI CUBE OPEN 2018”** organized in association with **“World cube Association & Deccan Cubing”** on 21st January 2018.

Faculty Coordinators

Principal
PRINCIPAL

Geethanjali College of Engg. and Tech.
Cheeryal (V), Keesara (M), Medchal Dist.(T.S.)-501 301.

PRINCIPAL
Geethanjali College of Engg. Tech.
Cheeryal (V), Keesara (M), R.R. Dist. (A.P.) - 501 301

Sponsored by **TEJA EDUCATIONAL SOCIETY, HYDERABAD**

Office : Sy. No. 33 & 34, Cheeryal (V), Keesara (M), Medchal Dist. - 501 301.

Phones : 9533791618, 7306295152



Geethanjali

Phone : 9533791618
Fax : +91-40-24220320
Website : www.geethanjaliinstitutions.com
info@gcet.edu.in

Geethanjali College of Engineering and Technology

AUTONOMOUS

(Accredited by NBA, Approved by AICTE, New Delhi)

Sy.No. 33 & 34, Cheeryal (V), Keesara (M), Medchal District. - 501 301.

GEETHANJALI CUBE OPEN 2018

Letter of Appreciation

We appreciate the exemplary efforts of **Ms. A.Ananya Rao (CSE-2B)** as volunteer of the event “**GEETHANJALI CUBE OPEN 2018**” organized in association with “**World cube Association & Deccan Cubing**” on 21st January 2018.

Faculty Coordinators

Principal
PRINCIPAL
Geethanjali College of Engg. and Tech.
Chaeryal (V), Keesara (M), Medchal Dist.(T.S.)-501 301.

PRINCIPAL
Geethanjali College of Engg. Tech.
Chaeryal (V), Keesara (M), R.R. Dist. (A.P.) - 501 301

Sponsored by **TEJA EDUCATIONAL SOCIETY, HYDERABAD**

Office : Sy. No. 33 & 34, Cheeryal (V), Keesara (M), Medchal Dist. - 501 301.

Phones : 9533791618, 7306295152



Geethanjali

Phone : 9533791618
Fax : +91-40-24220320
Website : www.geethanjaliinstitutions.com
info@gcet.edu.in

Geethanjali College of Engineering and Technology

AUTONOMOUS

(Accredited by NBA, Approved by AICTE, New Delhi)

Sy.No. 33 & 34, Cheeryal (V), Keesara (M), Medchal District. - 501 301.

GEETHANJALI CUBE OPEN 2018

Letter of Appreciation

We appreciate the exemplary efforts of **Ms. B.Tulasi (ECE-2B)** as volunteer of the event "**GEETHANJALI CUBE OPEN 2018**" organized in association with "**World cube Association & Deccan Cubing**" on 21st January 2018.

Faculty Coordinators

Handwritten signatures of faculty coordinators.

Handwritten signature of the Principal.
Principal

Geethanjali College of Engg. and Tech.
Cheeryal (V), Keesara (M), Medchal Dist.(T.S.)-501 301.

Handwritten signature of the Principal.
PRINCIPAL
Geethanjali College of Engg. Tech.
Cheeryal (V), Keesara (M), R.R. Dist. (A.P.) - 501 301

Sponsored by **TEJA EDUCATIONAL SOCIETY, HYDERABAD**

Office : Sy. No. 33 & 34, Cheeryal (V), Keesara (M), Medchal Dist. - 501 301.

Phones : 9533791618, 7306295152



Geethanjali

Phone : 9533791618
Fax : +91-40-24220320
Website : www.geethanjaliinstitutions.com
info@gcet.edu.in

Geethanjali College of Engineering and Technology

AUTONOMOUS

(Accredited by NBA, Approved by AICTE, New Delhi)

Sy.No. 33 & 34, Cheeryal (V), Keesara (M), Medchal District. - 501 301.

GEETHANJALI CUBE OPEN 2018

Letter of Appreciation

We appreciate the exemplary efforts of **Ms. Anjali Rao (CSE-2D)** as volunteer of the event **“GEETHANJALI CUBE OPEN 2018”** organized in association with **“World cube Association & Deccan Cubing”** on 21st January 2018.

Faculty Coordinators

Principal
PRINCIPAL
Geethanjali College of Engg. and Tech.
Cheeryal (V), Keesara (M), Medchal Dist.(T.S.)-501 301.

PRINCIPAL
Geethanjali College of Engg. Tech.
Cheeryal (V), Keesara (M), R.R. Dist. (A.P.) - 501 301

Sponsored by **TEJA EDUCATIONAL SOCIETY, HYDERABAD**

Office : Sy. No. 33 & 34, Cheeryal (V), Keesara (M), Medchal Dist. - 501 301.

Phones : 9533791618, 7306295152



J-HUB: ENLITE
VENTURE VOYAGER 2018

TEAM NO:

DATE OF SUBMISSION:

TEAM :

TEAM EMAIL:

WORKSHEET- 3

LEGAL STRUCTURE & START-UP CHECKLIST

Reference Pages: 7 to 17

K

PRINCIPAL
Geethanjali College of Engg. Tech.
Cheruvu (V), Kasera (M), R.R. Dist. (A.P.) - 501 301

CONTACT DETAILS:





J-HUB: ENLITE
VENTURE VOYAGER 2018

TEAM NO:

DATE OF SUBMISSION:

TEAM :

TEAM EMAIL:

M

WORKSHEET- 7

COST & REVENUE

Reference Pages: 13 to 15

CONTACT DETAILS:



.....https://docs.google.com/forms/d/e/1FAIpQLSciEST7DbQd7KHx8s4vEXkmW47Hs547FPZitmESRQc9Pyw-RA/viewanalytics

The screenshot shows a Google Form titled "Institute Signup Form to J-Hub" from Jawaharlal Nehru Technological University Hyderabad. The form includes a logo of the university, a required email address field, and a text field for the institute name. A dark banner at the bottom of the form contains the text "Faculty (2) Identified to coordinate the activities of I-Cell".

Institute Signup Form to J-Hub
Jawaharlal Nehru Technological University Hyderabad

* Required

Email address *
info@gcet.edu.in

Name of the Institute
Geethanjali College of Engineering and T

Faculty (2) Identified to coordinate the activities of I-Cell

K

PRINCIPAL
Geethanjali College of Engg. Techn.
(Cheerla (M), Keesara (M), R.R. Dist. (A.P.) - 501 301)

[Institute Signup Form to X](#) | [Secure](#) | [https://docs.google.com/forms/d/e/1FAIpQLSdEST7Db-Qd7KHx8s4vEXkmW47Hs547FPZtmESRQc9pyw-RA/viewform?c=0&w=1&includes_info_params=true](#) | [MCQs on Sorting wit](#)

- Faculty (2) Identified to coordinate the activities of I-Cell

Name of the Faculty Incharge 1 *	_____
N. Chandrakanth	
Contact Number *	_____
9885723157	
Email Id *	_____
chandra.nagui.apalli@gmail.com	
Name of the Faculty Incharge 2 *	_____
O.V.P.R. Sivakumar	
Contact Number *	_____
9490933019	

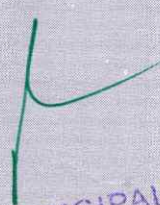
PRINCIPAL
 Geethanjali College of Engg. Techn.
 (Cheryl (P)), Kotturu (M), A.R. Dist. (A.R.) - 501 301

No.GCET/041/2017-18

21.08.2017

OFFICE OF THE PRINCIPAL

CIRCULAR

The “i-cell” (innovation cell) of Geethanjali College of Engineering and Technology will constitute of the following members for the year 2017-18.

Sl.No.	Name	Dept.	Role	Signature
1	Dr. S. Udaya Kumar		Chairman	
2	Prof. N. Chandrakanth	CSE	Convener	
3	Prof. Siva Kumar Ogirala	ECE	Member	
4	Dr. Sita Madhavi	MBA	Member	
5	Y.V.N. Phani Kishore	CSE	Member	
6	Preeti Prasada	CSE	Member	
7	P. Harish	EEE	Member	
8	B. Subba Rao	ME	Member	
9	Y. Rajesh Kumar	CE	Member	

PRINCIPAL

Copy to:

- Secretary Sir's office
- Dean Academics
- Dean Admin
- Members mentioned above

PRINCIPAL
Geethanjali College of Engg. Tech.
Cheeryal (V), Keesara (M), R.R. Dist. (A.P.) - 501301

CAREER GUIDANCE

1. Did you decide what you want to do after B.Tech? If yes, please mention your career plan:

2. Is U.S/U.K education right for you?

3. Do you have any knowledge about QS World University Ranking for MS/MBA Programme in your discipline?

4. If you have opted M.S/M.B.A programme abroad, when do you plan to take your GRE/TOEFL/IELTS?

5. If you have decided to pursue M. Tech, when do you plan to take GATE/ PG CET?

6. Are you contemplating to take coaching for GRE? If so, do you know the institutes which offer coaching for GRE/TOEFL/IELTS?

7. Do you know that a GRE score of less than 310 is considered a below average score?

8. Are you aware of the fact that the deadline of applications for US Universities closes by November 30 every year and UK universities or UCAS by 15 October every year?

9. Do you know that Statement of Purpose (SOP)/ Personal Statement plays a very crucial role in the admission process for M.S (U.S.A or U.K) along with a good academic track record?

10. Did you prepare a sample copy of SOP? Do you need any help in the preparation of SOP?

11. Have you made sure that your scores of GRE? TOEFL? IELTS along with your application are submitted in the university before the dead line?

12. Do you know it costs about Rs 35 lakhs or so to do MS abroad? (Y/N)

13. Are you aware that you are eligible for scholarships or fee waiver if you have 80% and above in your academics in Engineering?

14. Are you aware of the following premier Business Management institutes of India? Specify your choice: 1.XLRI Xavier School of Management 2. Indian Institute of Foreign Trade 3. S.P.Jain Institute of Management.4. Faculty Management Studies 5. IIM (Ahmedabad/Shillong/Bengaluru/Kolkata/Cochin) 6. Shaillesh Mehatha School of Management

PRINCIPAL
Geethanjali College of Engg. Tech.
Cheerayal (V), Keesara (M), R.R. Dist. (A.P.) - 501 301



Geethanjali College of Engineering and Technology

CHEERYAL (V), KEESARA (M), Medchal DIST-501301, Telangana

Date: 29 Dec 2017

Strategy to Support Innovation and Entrepreneurship at Geethanjali College of Engineering and Technology (GCET)

- Conduct sessions through workshops/webinars/seminars/lectures by eminent speakers/resource persons from Industry and academia, and identify students with innovative ideas through campaigning which can culminate into innovative projects, and provide seed fund to the project for creating a working model/prototype, which shall be carried out in the incubation cell of the college.
- To bring more number of students under the umbrella of student innovations and student entrepreneurship, a course/laboratory course on 'design thinking' may be introduced across all disciplines.
- The college has established an Entrepreneurship Development Cell (EDC) in collaboration with National Entrepreneurship Network (NEN) cell (guided by Wadhvani Foundation) which shall work in coordination with the incubation cell.
- Students are encouraged to take up their mini/major project with an incubator (University/College/Govt Recognized). They shall take prior approval from respective department to which the student belongs to and shall complete all requirements such as project reviews and project report submission etc. to earn credits as per the university/college regulations.
- The student may opt to present their innovation/Startup idea/patent draft for Seminar/Technical paper writing components as per the course structure and earn credits as per the regulations.
- GCET shall consider a maximum of 10% of concession in attendance for student participation in Innovation/Startup events and incubator programs. However, prior grant of leave and proof of participation is mandatory to consider attendance for the period in consideration and can be availed only once at any stage of company formation.
- Students are encouraged to opt courses through NPTEL or any MOOCs.
- Assistance in legal and financial services shall be given for startup companies established by students and/or faculty.
- GCET shall facilitate and train the startups for pitching to venture capital funds/investors, in collaboration with other incubators, if required.



S. N. Srinivasulu Reddy
PRINCIPAL

Geethanjali College of Engg. and Tech.
Cheeryal (V), Keesara (M), Medchal Dist.(T.S.)-501 301.

EXCITE - 2017 CERTIFICATE

..... **Rahul N D**

This is to certify that

PRINCIPAL
Geethanjali College of Engineering & Technology,
Cheeryal (V), Raesara (M), R.R. Dist. (M), 501 301

Student of **GEETHANJALI COLLEGE OF ENGINEERING AND TECHNOLOGY** completed their

product prototype in "**EXCITE - 2017 - Summer Product Engineering Workshop**" held

during May 20th - June 17th, 2017 organized by Jawaharlal Nehru Technological

University Hyderabad in collaboration with HYSEA and TASK

Ranga Pothula

Ranga Pothula
President, HYSEA



Powered by:

Dr. N. Yadaiah
Registrar, JNTUH

Sujiv Nair
Sujiv Nair
CEO, TASK

Anchored by:

IDEALABS



TASK

EXCITE - 2017 CERTIFICATE



PRINCIPAL
Geethanjali College of Engg. Tech.
Keesara (M), R.R. Dist. (A.P.) - 501 301

This is to certify that **Rahul N D**

Student of **GEETHANJALI COLLEGE OF ENGINEERING AND TECHNOLOGY** completed their product prototype in "**EXCITE - 2017 - Summer Product Engineering Workshop**" held during May 20th - June 17th, 2017 organized by Jawaharlal Nehru Technological

University Hyderabad in collaboration with HYSEA and TASK

Ranga Pothula

Ranga Pothula
President, HYSEA



Powered by:

Sujiv Nair

Sujiv Nair
CEO, TASK

Anchored by:

IDEALABS



TASK

EXCITE - 2017 CERTIFICATE

Dr. R. S. LAKSHMI
Geethanjali College of Engg. Tech
Cheerla (V), Keesara (M), R.R. Dist. (A.P.) - 505 201

This is to certify that **Vardhaman Ayyagari**

Student of **GEETHANJALI COLLEGE OF ENGINEERING AND TECHNOLOGY** completed their

product prototype in "**EXCITE – 2017 - Summer Product Engineering Workshop**" held

during May 20th – June 17th, 2017 organized by Jawaharlal Nehru Technological

University Hyderabad in collaboration with HYSEA and TASK

Ranga Pothula

Ranga Pothula
President, HYSEA



Powered by:

Sujiv Nair

Sujiv Nair
CEO, TASK

Dr. N. Yadaiah
Registrar, JNTUH

Anchored by:

IDEALABS



TASK

EXCITE - 2017 CERTIFICATE

This is to certify that **Vardhaman Ayyagari**

Student of **GEETHANJALI COLLEGE OF ENGINEERING AND TECHNOLOGY** completed their product prototype in **"EXCITE – 2017 - Summer Product Engineering Workshop"** held during May 20th – June 17th, 2017 organized by Jawaharlal Nehru Technological University Hyderabad in collaboration with HYSEA and TASK

Ranga Pothula
Ranga Pothula
President, HYSEA



Powered by:

Sujiv Nair
Sujiv Nair
CEO, TASK

Dr. N. Yadaiah
Registrar, JNTUH

Anchored by:

IDEALABS



TASK

EXCITE - 2017 CERTIFICATE

PRINCIPAL
Geethanjali College of Engineering
Cheerla (V), Keesara (M), R.R. Dist. (A.P.) - 501 301

This is to certify that **M Pooja**

Student of **GEETHANJALI COLLEGE OF ENGINEERING AND TECHNOLOGY** completed their

product prototype in "**EXCITE - 2017 - Summer Product Engineering Workshop**" held

during May 20th - June 17th, 2017 organized by Jawaharlal Nehru Technological

University Hyderabad in collaboration with HYSEA and TASK

Ranga Pothula

Ranga Pothula
President, HYSEA



Powered by:

Sujiv Nair

Sujiv Nair
CEO, TASK

Dr. N. Yadaiah
Registrar, JNTUH

Anchored by:

IDEALABS



Geethanjali College of Engineering and Technology
(UGC Autonomous)

CHEERYAL (V), KEESARA (M) - 501301, Telangana, India

Sl. No.	Name of Project	Student Details		Status
		Name	Roll No	
Year: 2016-17				
1	CYLIMON	Rahul N D M Pooja Vardhaman Ayyagari	15R11A05F6 15R11A0532 15R11A0517	Prototype Completed
2	Smart Trash Bin	Sai Bhargavi A Navya Ambati Siva Sai	14R11A0404 14R11A0470 14R11A04J3	Prototype Completed
3	Medical box with care	M Sai Krupa Reddy Amabti Chimanyi D.S. Jaya Madhavi	15R11A0494 15R11A04J1 15R11A0472	Prototype Completed

R. S. Reddy
Dept. of Computer Science & Engineering
Geethanjali College of Engineering & Technology
Cheeryal (V), Keesara (M), Medchal (Dist.)

[Signature]
Geethanjali College of Engineering & Technology
Cheeryal (V), Keesara (M), R.R. Dist. (A.P.) - 501301



Geethanjali College of Engineering and Technology
(UGC Autonomous)

CHEERYAL (V), KEESARA (M) - 501301, Telangana

Date: May 9th, 2017

To
The Principal
Geethanjali College of Engineering and Technology
Cheeryal
Telangana - 501301.

Respected Sir,

Sub: Attending the Workshop on UAV - Regarding

We would like to attend a workshop being conducted by Skyfi Labs, in Hyderabad starting May 22nd till May 27th, 2017. The cost for the same will be Rs 3490/- per person. We will be thankful if this amount can be reimbursed by the college.

We request you to please consider the time we are attending the workshop as On-duty. We do not have any impact on the classes as the final exams are in progress and there is no class work.

Thanking you

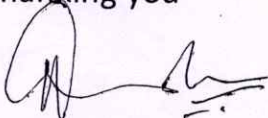
Prof. N. Chandrakanth
CSE, GCET

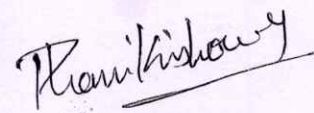
Mr. Y.V. N. Phani Kishore
CSE, GCET
PRINCIPAL
Geethanjali College of Engg. Tech.
Cheeryal (V), Keesara (M), R.R. Dist. (A.P.) - 501 301

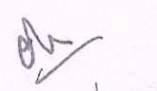
Secretary
Geethanjali College of Engg. Tech.
Cheeryal (V), Keesara (M), R.R. Dist. (A.P.) - 501 301
Pay Adm Recd
2017-05-09

Submitted to Secretary to
with a request to pay Rs. 2,000
to each person as it is very
useful for the incubation center

2017

VERIFIED
CERTIFICATE

skyfi labs
LEARN ENGINEERING.
PRACTICALLY!
PRINCIPAL
Geethanjali College of Engg. Tech.
Chennai, Tamil Nadu (India) - 600 034

LEARN AEROSPACE. PRACTICALLY!

www.aerotrix.com
www.skyfilabs.com

16 February 2017

COE Guindy Anna University,
Chennai

This is to certify that

Y V N PHANI KISHORE

has completed a 2-day project-based training program on

Delta Wing

Unique Certificate Code: **3: 230239**

Verify at www.skyfilabs.com/verify-certificate/33230239



Pavan Kumar P
CEO, Skyfi Labs

VERIFIED
CERTIFICATE

PRINCIPAL
Goethenraji College of Engg. Tech.
Cheerlaji (V), Ahasara (M), R.R. Dist. N.T. 501 301

skyfi labs

LEARN ENGINEERING.
PRACTICALLY!

LEARN AEROSPACE. PRACTICALLY!

www.aerotrix.com
www.skyfilabs.com

27 May 2017

Skyfi Labs Center, Abids,
Hyderabad

This is to certify that

Y V N PHANI KISHORE

has completed a 6-day project-based training program on

Quadrotor and RC Aircraft

Unique Certificate Code: **34360006**

Verify at www.skyfilabs.com/verify-certificate/34360006



Pavan Kumar P
CEO, Skyfi Labs

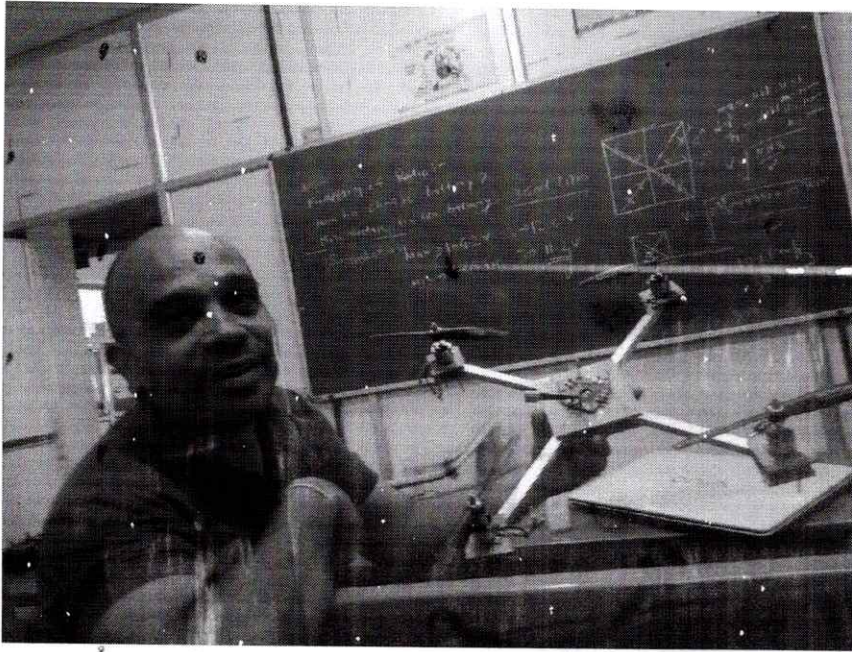

PRINCIPAL
Geethanjali College of Engg. Tech.
Cheerpal (V), Keesara (M), R.R. Dist. (A.P.) - 501 307

Invoice



From

Skyfi Education Labs Pvt Ltd
2nd Floor, Above Titan Showroom, Opp Innovative
Multiplex, Marathahalli, Bangalore
Bangalore, Karnataka, 560037
India
Tax ID: Service Tax: AASCS5790GSD001

Invoice No.
MY17010C

Date
May 22 2017

Invoice Due
May 22 2017

To

N.Chandrakanth
India

Description	Quantity	Rate	Amount
Summer Training Program in Aeromodelling - RC Aircraft and Quadrotor by AeroTriX	1	3034.78	USD 3034.78
+ Service Tax + SBC + KKC (15%) - USD 455.22			
Sub Total			3,034.78
Tax Total			455.22
Total			USD 3,490.00
Paid to Date			USD 3,490.00
Balance			USD 0.00

For any queries, please contact: Bheru Singh - 8971227420 - bheru@skyfilabs.in



M
PRINCIPAL
Geethanjali College of Engg. Techn.
Cheerl (V), Keesara (M), R.R. Dist. (A.P.) - 501 361

GEETHANJALI COLLEGE OF ENGINEERING AND TECHNOLOGY
Cheeryal (V), Keesara (M), R.R. Dist., PIN - 501 301

PERMISSION TO GO ON ON-DUTY

11/5/17
Date

Name: Prof. N. Chandrakanth
Designation: Professor
Department: CSE
Purpose: Workshop on UAV
Place of On-Duty: Sujatha College, Abids, Hyderabad
Date: 22/5/17 to 24/5/17
Arrange arrangement for class work: - NA -

Sign. Of the Faculty



Principal

GEETHANJALI COLLEGE OF ENGINEERING AND TECHNOLOGY
Cheeryal (V), Keesara (M), R.R. Dist., PIN - 501 301

PERMISSION TO GO ON ON-DUTY

Date: 11/5/17

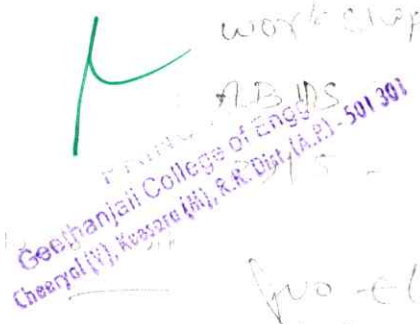
Name: Y. V. N. Phan Kirshore
Designation: Asst Prof
Department: CSE
Purpose: Workshop on Quadcopter Drone
Place of On-Duty: ABIDS Sujatha College
Date: 27/5 - 27/5

Geethanjali College of Engineering and Technology
Cheeryal (V), Keesara (M), R.R. Dist., PIN - 501 301

Sign. Of the Faculty

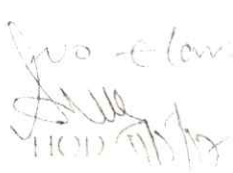
Principal



TASK

EXCITE - 2017 CERTIFICATE

This is to certify that **Abhijeet Kumar**

Student of **GEETHANJALI COLLEGE OF ENGINEERING AND TECHNOLOGY** completed their
product prototype in "**EXCITE - 2017 - Summer Product Engineering Workshop**" held

during May 20th - June 17th, 2017 organized by Jawaharlal Nehru Technological

University Hyderabad in collaboration with HYSEA and TASK

Ranga Pothula
Ranga Pothula
President, HYSEA

Dr. N. Yadaiah
Registrar, JNTUH

Sujiv Nair
Sujiv Nair
CEO, TASK

PRINCIPAL
Geethanjali College of Engineering & Technology
Cheerla (V), Keesara (M), R.R. Dist. (N), 501 301



Powered by:

Anchored by:

IDEALABS



TASK

EXCITE - 2017 CERTIFICATE

PRINCIPAL
Geethanjali College of Engg. Tech.
Cheerla (V), Keesara (M), R.R. Dist. (P) - 501

[Handwritten mark]

This is to certify that **Abhijeet Kumar**

Student of **GEETHANJALI COLLEGE OF ENGINEERING AND TECHNOLOGY** completed their product prototype in "**EXCITE - 2017 - Summer Product Engineering Workshop**" held

during May 20th - June 17th, 2017 organized by Jawaharlal Nehru Technological

University Hyderabad in collaboration with HYSEA and TASK

[Handwritten Signature]
Ranga Pothula
President, HYSEA



[Handwritten Signature]
Sujiv Nair
CEO, TASK

Dr. N. Yadaiah
Registrar, JNTUH

Powered by:

Anchored by:

IDEALABS



TASK

EXCITE - 2017 CERTIFICATE

PRINCIPAL
Geethanjali College of Engineering & Technology
Cheerla (V), Keesara (M), R.R. Dist. (A.P.) - 501 301

This is to certify that **AMBATI CHINMAYI**

Student of **GEETHANJALI COLLEGE OF ENGINEERING AND TECHNOLOGY** completed their

product prototype in **"EXCITE – 2017 - Summer Product Engineering Workshop"** held

during May 20th – June 17th, 2017 organized by Jawaharlal Nehru Technological

University Hyderabad in collaboration with HYSEA and TASK

Ranga Pothula

Ranga Pothula
President, HYSEA



Powered by:

Sujiv Nair

Sujiv Nair
CEO, TASK

Anchored by:

IDEALABS



TASK

EXCITE - 2017 CERTIFICATE

This is to certify that **AMBATI CHINMAYI**

Student of **GEEETHANJALI COLLEGE OF ENGINEERING AND TECHNOLOGY** completed their product prototype in "**EXCITE - 2017 - Summer Product Engineering Workshop**" held

during May 20th – June 17th, 2017 organized by Jawaharlal Nehru Technological

University Hyderabad in collaboration with HYSEA and TASK

Ranga Pothula

Ranga Pothula
President, HYSEA

Sujiv Nair

Sujiv Nair
CEO, TASK

PRINCIPAL
Geethanjali College of Engineering & Technology
Cheerla (V), Kosuru (M), R.R. Dist. 501 301



Powered by:

Anchored by:

IDEALABS



TASK

EXCITE - 2017 CERTIFICATE

This is to certify that **D.SAI JAYA MADHAVI**

Student of **GEETHANJALI COLLEGE OF ENGINEERING AND TECHNOLOGY** completed their

product prototype in **"EXCITE – 2017 - Summer Product Engineering Workshop"** held

during May 20th – June 17th, 2017 organized by Jawaharlal Nehru Technological

University Hyderabad in collaboration with HYSEA and TASK

Ranga Pothula

Ranga Pothula
President, HYSEA



Powered by:

Sujiv Nair

Sujiv Nair
CEO, TASK

Anchored by:

IDEALABS



TASK

EXCITE - 2017 CERTIFICATE

This is to certify that **D.SAI JAYA MADHAVI**.....

Student of **GEETHANJALI COLLEGE OF ENGINEERING AND TECHNOLOGY** completed their

product prototype in **"EXCITE – 2017 - Summer Product Engineering Workshop"** held

during May 20th – June 17th, 2017 organized by Jawaharlal Nehru Technological

University Hyderabad in collaboration with HYSEA and TASK

PRINCIPAL
Geethanjali College of Engg. Tech.
Cheeryal (V), Keesara (M), R.R. Dist. (A.P.) 501 301

Ranga Pothula

Ranga Pothula
President, HYSEA



Powered by:

Sujiv Nair

Sujiv Nair
CEO, TASK

Anchored by:

IDEALABS



TASK

EXCITE - 2017 CERTIFICATE

This is to certify that **M. SAIKRUPA REDDY**.....

Student of **GEETHANJALI COLLEGE OF ENGINEERING AND TECHNOLOGY**..... completed their

product prototype in "**EXCITE - 2017 - Summer Product Engineering Workshop**" held

during May 20th - June 17th, 2017 organized by Jawaharlal Nehru Technological

University Hyderabad in collaboration with HYSEA and TASK

Ranga Pothula

Ranga Pothula
President, HYSEA



Powered by:

Sujiv Nair

Sujiv Nair
CEO, TASK

Anchored by:

IDEALABS

PRINCIPAL
Geethanjali College of Engineering
Cheerl (V), Aesuru (M), R.R. Dist. (C) 501 301



TASK

EXCITE - 2017 CERTIFICATE

This is to certify that **M. SAIKRUPA REDDY**.....

Student of **GETHANJALI COLLEGE OF ENGINEERING AND TECHNOLOGY**..... completed their

product prototype in "**EXCITE - 2017 - Summer Product Engineering Workshop**" held

during May 20th - June 17th, 2017 organized by Jawaharlal Nehru Technological

University Hyderabad in collaboration with HYSEA and TASK

Ranga Pothula

Ranga Pothula
President, HYSEA



Powered by:

Sujiv Nair

Sujiv Nair
CEO, TASK

Anchored by:

IDEALABS

PRINCIPAL
Geethanjali College of Engineering & Technology
Geethanjali, Secunderabad (N), A.R. District - 501 301



TASK

EXCITE - 2017 CERTIFICATE

This is to certify that **CH.SAI BHARGAVI**.....

Student of **GEETHANJALI COLLEGE OF ENGINEERING AND TECHNOLOGY**..... completed their product prototype in "**EXCITE – 2017 - Summer Product Engineering Workshop**" held during May 20th – June 17th, 2017 organized by Jawaharlal Nehru Technological University Hyderabad in collaboration with HYSEA and TASK

Ranga Pothula

Ranga Pothula
President, HYSEA



Powered by:

Sujiv Nair

Sujiv Nair
CEO, TASK

Dr. N. Yadaiah
Registrar, JNTUH

Anchored by:

IDEALABS

EXCITE - 2017 CERTIFICATE

CH.SAI BHARGAVI

This is to certify that

Student of **GEETHANJALI COLLEGE OF ENGINEERING AND TECHNOLOGY** completed their

product prototype in "**EXCITE - 2017 - Summer Product Engineering Workshop**" held

during May 20th - June 17th, 2017 organized by Jawaharlal Nehru Technological

University Hyderabad in collaboration with HYSEA and TASK



Ranga Pothula
President, HYSEA



Powered by:

Dr. N. Yadaiah
Registrar, JNTUH



Sujiv Nair
CEO, TASK

Anchored by:

IDEALABS



TASK

EXCITE - 2017 CERTIFICATE

This is to certify that **A.SHIVASAI**.....

Student of **GEE THANJALI COLLEGE OF ENGINEERING AND TECHNOLOGY**..... completed their

product prototype in "**EXCITE – 2017 - Summer Product Engineering Workshop**" held

during May 20th – June 17th, 2017 organized by Jawaharlal Nehru Technological

University Hyderabad in collaboration with HYSEA and TASK

Ranga Pothula
Ranga Pothula
President, HYSEA



Powered by:

Sujiv Nair
Sujiv Nair
CEO, TASK

Dr. N. Yadaiah
Registrar, JNTUH

Anchored by:

IDEALABS



TASK

EXCITE - 2017 CERTIFICATE

This is to certify that **A.SHIVASAI**.....

Student of **GEETHANJALI COLLEGE OF ENGINEERING AND TECHNOLOGY**..... completed their

product prototype in "**EXCITE - 2017 - Summer Product Engineering Workshop**" held

during May 20th - June 17th, 2017 organized by Jawaharlal Nehru Technological

University Hyderabad in collaboration with HYSEA and TASK

Ranga Pothula

RangaPothula
President, HYSEA



Powered by:

Sujiv Nair

Sujiv Nair
CEO, TASK

Dr. N. Yadaiah
Registrar, JNTUH

Anchored by:

IDEALABS



TASK

EXCITE - 2017 CERTIFICATE

[Signature]
PRINCIPAL
Geethanjali College of Engineering & Technology
Cheerl (V), Keeravaram (M), R.R. Dist. (A.P.) - 500044

This is to certify that **M Pooja**

Student of **GEETHANJALI COLLEGE OF ENGINEERING AND TECHNOLOGY** completed their

product prototype in "**EXCITE - 2017 - Summer Product Engineering Workshop**" held

during May 20th - June 17th, 2017 organized by Jawaharlal Nehru Technological

University Hyderabad in collaboration with HYSEA and TASK

[Signature]
Ranga Pothula
President, HYSEA



Powered by:

Dr. N. Yadaiah
Registrar, JNTUH

[Signature]
Sujiv Nair
CEO, TASK

Anchored by:

IDEALABS

JNTUH-EXCITE

Summer Product Engineering Workshop
in association with HYSEA and Hyderabad Hackers
with support from TS State Innovation Cell

PRINCIPAL
Geethanjali College of Engg. Tech.
Cheeryal (V), Keasara (M), R.R. Dist. (A.P.) - 501 301

EXCITE is a one month summer Product Engineering/ Innovation/ Entrepreneurship workshop to Ideate, learn cutting edge skills and implement Product prototypes with the active support from mentors and Startups.

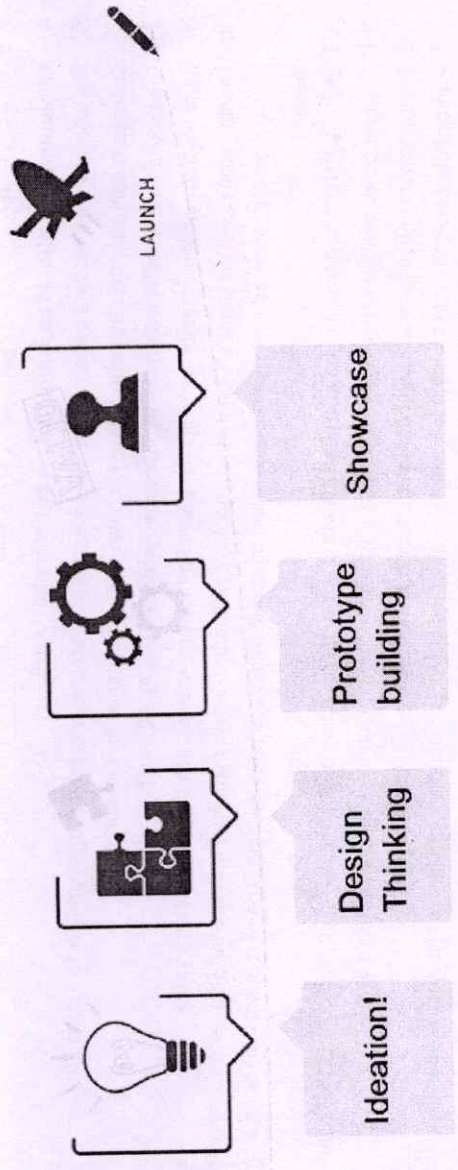

EXCITE

TO
HKT
See 13/04

PRINCIPAL
Geethanjali College of Engg. Tech.
Cheeryal (V), Keasara (M), R.R. Dist. (A.P.) - 501 301

PRINCIPAL
Geethanjali College of Engineering, Technology & Management
Keesara (M), K.R. Reddy (V), Keerthi (A.P.)

Programme Implementation:

1. The programme will be conducted at JNTU Kukatpally and run for six days in a week from 9.30am – 6.00pm. In some exceptional cases, participants may be asked to come on Sundays as well.

- 2. The programme is for a duration of four weeks extensible to five weeks and tentative scheduled between May 15 – June 20.
- 3. College shall allow the completion of the programme and consider the attendance of the students participating in this programme
- 4. The college representatives are welcome to visit the venue and see the progress of their students
- 5. The participants will get certificate, credits and the work done by the students in this period may be treated as their mini project.
- 6. The food, travel and accommodation has to be borne by the participants themselves
- 7. The participants are expected to procure their own hardware kits, sensors and all requisite hardware.
- 8. The participating teams are expected to get their own laptops

9. For any further queries please feel free to mail us at excite4innovation@gmail.com

Rahul ND
14R11A05F6

M. Pooja
14R11A0532

Chandra Nagulapalli <chandra.nagulapalli@gmail.com>
to Nagender, Udaya, Prof, Sivakumar

Respected Sir,

I and Sivakumar Sir (from ECE) have nominated 3 teams to EXCITE 17 program.
We have 1 team from CSE 3rd year, 1 team from ECE 3rd year and one team from ECE 2nd year as per the EXCITE guidelines.

Please find the attached document which gives the details of the students from various teams.

NOTE: EXCITE program starts on 15th May 2017 but the students have exams till May 19th. I will send a mail to them requesting reschedule of the same.

Thanks and regards
N. Chandrakanth

On Mon, Apr 24, 2017 at 3:17 PM, Udaya Susarla <uksusarla@gmail.com> wrote:
For necessary action please

Best Regards,

Dr. Udaya Kumar **Susarla** B.E., M.E., M.Tech (Hons), PhD
Principal
Geethanjali College of Engineering and Technology,
Cheeryala (V), Keesara (M),
Rangareddy Dist. Telangana, Hyderabad - 501301
Cell: +91-9912744988;

----- Forwarded message -----

From: VIJAYAKUMARI GUNTA <vijayakumari.gunta@gmail.com>
Date: Mon, Apr 24, 2017 at 10:47 AM
Subject: EXCITE 2017 - Last Date of Submission Extended to 25th April 2017
To: AAR MAHAVEER <principal.8p@gmail.com>, Principal Aarushi <principalaarushi@gmail.com>, janardhan muppala <jc_muppala@yahoo.co.in>, hitech_enggcollege@yahoo.co.in, aceenggcollege@gmail.com, Chandrasekhar Paritala <principaladams@gmail.com>, Avcr College <principal7777@gmail.com>, amkpr@yahoo.com, aizzacet@yahoo.com, Principal Al Habeeb <principal@alhabeebcollege.ac.in>, principal.alexander@hotmail.com, Amina College <aminacollege2004@gmail.com>, Principalfg Amr <principalfg@gmail.com>, ANASUYA DEVI EDUCATIONAL SOCIETY <adit.principal@gmail.com>, Principal Annamacharya College <principalaiith@gmail.com>, Anubose institute of technology <abitintu@gmail.com>, principal@anuraghyd.ac.in, principal@anurag.ac.in, info@cvsr.ac.in, ksrao_prn@rediffmail.com, principal.pharmacy@anurag.ac.in, anwarululoom@rediffmail.com, aucoph@gmail.com, Apoorva College Karimnagar <apoorvacollege@gmail.com>, ACTS PRINCIPAL <principalacts@gmail.com>, arjun_acts05@yahoo.com, arkay.college@gmail.com, arvindaksha_principal@yahoo.co.in, gorthisharma@gmail.com, aryabhata.its@gmail.com, principalxq@ashoka.ac.in, principal5t@ashoka.ac.in, AsifiaCollege Engg <h2principalasifia@gmail.com>, aurobindoengg6z@gmail.com, principal_u7@yahoo.com, Auroras <atma9k@gmail.com>, PRINCIPAL AEC <principal@aurora.ac.in>, ARTI Aurora <principal.arti@gmail.com>, astim9principal@gmail.com, astrad9@gmail.com, director@atri.edu.in, Avanthi Principal <principal.avanthi@gmail.com>, AVANTHI INST OF PHARMACEUTICAL SCIENCES GUNTHAPALLY <principalgn@gmail.com>, Apra Principal <principalapra@gmail.com>, asraprincipal@gmail.com, AVN INSTITUTE OF ENGINEERING AND TECHNOLOGY <avn.principal@gmail.com>, "P.L.Sreenivasa Rao" <principal.amce@gmail.com>, H3_ayaancollege@yahoo.co.in, azad_examcell@yahoo.com, kp_pharma@gmail.com, PRINCIPAL BVRIT <vyasodhasivakumar@gmail.com>, DHRUVA PRINCIPAL <dhruvaengg2008@gmail.com>, Principal Vrkj <aohiet@gmail.com>, hasvitaa69@yahoo.com, phpcet@gmail.com, hits.vim2003@gmail.com, Holymary institute of technology <principalhit@gmail.com>, principalhitscoe@gmail.com, shankarrao cheepuruapalli <shankar61ch@gmail.com>, hits.mca1994@gmail.com, Horizon College of Pharmacy HCP <horizoncollegeofpharmacy@gmail.com>, principal@hitam.org, ibs solipet <ibssolipet@gmail.com>, principal@induriet.edu.in, principal IARE <principal@iare.ac.in>, principal@ibiet.edu.in, info@jaqruti.ac.in, Jnit Jnit <principaljnit@gmail.com>, Jayamukhi Jips <jips_principal@gmail.com>, "Dr.Jayadev Gyani" <principal@jits.in>, principal.jpne@gmail.com, principal@jpnce.ac.in, Pricpal Jjcpm <principal.jjcpm@gmail.com>, principal.jiit@gmail.com, principal_jbrpc@yahoo.com, principal@jbrec.edu.in, office@jctech.in, principal@jctech.in, Principal JCP <principal.jcp@jctech.in>, JYOTHISHMATHI INSTITUTE OF PHARMACEUTICAL SCIENCE <principaljips@gmail.com>, principal@jits.edu.in, principal@jits.ac.in, Principal Kgr <principal@kgr.ac.in>, drprao@yahoo.com, principalkitsw6b@gmail.com, Kamakshi Kcet <kamakshi.cet@gmail.com>, kitssingapuram@yahoo.co.in, Kasireddy Narayan Reddy <knrexams@gmail.com>, kmpgc.kmm93@gmail.com, kbr_engineering@gmail.com, principal@kmit.in, Khader MA

PRINCIPAL
Geethanjali College of Engg. Tech.
Cheeryal (V), Keesara (M), R.R. Dist. (A.P.) - 501 301

<secretarysip@gmail.com>, principal@svsit.ac.in, srtipnalgonda@gmail.com, info@srtist.ac.in, Swami Vivekananda Pharmacy <svips2007@gmail.com>, sbce2006@gmail.com, swarna bharathi <sbimmba.mca@gmail.com>, sbit engg <sbitengg@gmail.com>, shcst.principal@gmail.com, Symbiosis College <symbiosiscollege2009@gmail.com>, principal.tpce@gmail.com, subudhi sanjeev@yahoo.co.in, tkrec@rediffmail.com, drvijayakuhana@gmail.com, Umamahesh Rao <raovattikuti@gmail.com>, nagi reddy Pandiri <tejacollegepharm@gmail.com>, Tirumala Integrated <tisttech@gmail.com>, tirumala_institutions@yahoo.com, trmloffice@gmail.com, info@tkrcet.ac.in, trinity.tctk@gmail.com, Trinity Cetpdpl <trinitycetpdpl@gmail.com>, Dasari MANOHAR REDDY <trinitypharmacypdpl@gmail.com>, Trinity College <principal.trinity@gmail.com>, Dr K srinivas rao <principaltrr@gmail.com>, "T. Ram Mohan Reddy" <trammohanreddy@gmail.com>, principaltrrcp@gmail.com, principal.trrec@gmail.com, tudi narasimha Reddy <trnit.principal@gmail.com>, trit.principal@gmail.com, principal.tist@gmail.com, UNITY COLLEGE OF PHARMACY <principalucp@gmail.com>, principalupg@gmail.com, Ram Reddy Kavadapu <ushodayabschool@gmail.com>, Vaagdevi College of Engineering <vaagdeviugl@gmail.com>, principal.vec@gmail.com, vaagdevipharmacy@gmail.com, chidurala srinivas <s4.principal@gmail.com>, Prince Vaageswari WN <principalvaageswari@gmail.com>, "Prof.KBRAO Principal" <principalum@gmail.com>, Boga Manohar <boga.manohar@gmail.com>, Raparla Ramakrishna <principal.ec@gmail.com>, principal@vnrviet.ac.in, postbox@vnrviet.ac.in, principal@vardhaman.org, vcppprincipal@gmail.com, vit.principal@gmail.com, VIPS Nalgonda <vipnsnalgonda@gmail.com>, webmaster_vbit@yahoo.com, Padmaja M <principalvjit@gmail.com>, vnitap@yahoo.com, VAIDYAM LAXMINARAYANA <principal_vvit@yahoo.co.in>, vif cet <vifcet2001@gmail.com>, vignan_pharmacy@yahoo.com, Principal Vits <principal.vits@gmail.com>, VIGNAN GHATKESAR <info.vmtw@gmail.com>, principal@vbithyd.ac.in, "Dr M.M RAO" <vcw.7e.nzb@gmail.com>, Vijay college of pharmacy <vcph.nzb@gmail.com>, vits_online@yahoo.co.in, vrec.29.nzb@gmail.com, vijayacollegeofpharmacy@gmail.com, Vijaya Institute of Management <vicm2007@gmail.com>, Sekhar Babu Pendyala <babups3@gmail.com>, "Vikas B.Pharmacy" <vikassuryapet@gmail.com>, Vamshi Vishnu <pharmvishnu77@gmail.com>, principal@viper.ac.in, exambranchvsit@gmail.com, vishwabharathienng@gmail.com, vbites2009@gmail.com, viswabharathipg@gmail.com, vbpgcemchevella@gmail.com, Vision Pharmacy <vcpsr2k7@gmail.com>, Visvesvaraya college of engg <vcethr@gmail.com>, Vivekananda Institute of Technology <principalvgih10@gmail.com>, Pasala Raja Prakasha Rao <praopasala@gmail.com>, vits1office@gmail.com, principal_n9@yahoo.co.in, Surya Prakash Lakkakula <principalvieb@gmail.com>

Dear Sir/Madam,

In continuation to the mail from DAP JNTUH, it is to inform that JNTUH is organizing a 4 week Summer Product Engineering Workshop EXCITE-2017 during May/June, 2017. EXCITE is a workshop to discover, nurture and refine technical product ideas and entrepreneurship among the Engineering students. The program guides in a structured manner engineering students pursuing B.tech(III year) in JNTUH constituent and affiliated colleges to develop tech product ideas. The innovative student ideas would be selected for mentoring by start-ups from HYSEA (Hyderabad Software Enterprises Association). An important outcome of the workshop is a demo prototype of their innovative ideas. Pl find the Guidelines enclosed .

EXCITE-2017 is third in the series organized by JNTUH and is scheduled between May 15, 2017 and June 16 2017. The last date for registration in extended to 25th April, 2017.

G. Vijaya Kumari

Professor
Dept. Of Computer Science & Engg
JNTU College of Engg, Kukatpally
Hyderabad-85

You received this message because you are subscribed to the Google Groups "gcetcac" group.
To unsubscribe from this group and stop receiving emails from it, send an email to gcetcac+unsubscribe@googlegroups.com.
To post to this group, send email to gcetcac@googlegroups.com.
To view this discussion on the web visit https://groups.google.com/d/msgid/gcetcac/CAPzo6Y%2B2BHNUJ7eJ_1Hn_fhE_LOuChPZ7%3D0hvk%3D3sPKc1aDFxBnQ%40mail.gmail.com.
For more options, visit <https://groups.google.com/d/optout>.

Chandra Nagulapalli <chandra.nagulapalli@gmail.com>

EXCITE Guidelines for Participating Colleges and Students

1. The Nomination form has to be filled by the Head of the Institution or an authorized person
2. The Nomination form should be filled on or before 20th April 2017
3. The students nominated in the form should be willing to complete the whole duration of the programme. The whole team will be disqualified if any student in the team is irregular due to any reasons.
4. We are introducing an option of nominating two teams from Third Year (completed writing exams for third Year) and one team from Second year (completed writing exams for Second Year).
5. The technology tracks in focus for EXCITE 2017 are IoT, Deep technologies like Artificial Intelligence, Machine learning, Augmented Reality/Virtual reality
6. The programme lays strong emphasis on self-learning, Peer learning. So while there will be a few technology workshops, it is expected that the participants work on their own. This is not a training programme.
7. We request the respective departments to do validation of ideas and make sure the ideas described in the form have a clear indication of the following :
 - Problem being solved
 - Current solution to the problem
 - Proposed solution (Innovation)
 - Target Customer
8. Please encourage your students to consider the following points before proposing the idea:
 - Is it a significant problem which needs to be solved
 - Who will pay for the solution
 - Is there a major innovation in the proposed solution
 - Is there a big market for the solution
 - Does the solution impact in a big way
 - Is the solution based on sound technology principles/standards and is it feasible to implement
9. It would further be appreciated if they do a quick validation of their idea with target customer base.

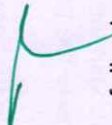

PRINCIPAL
Geethanjali College of Engg. Tech
Chennai (V), Keesara (M), Dist.

JNTUH-EXCITE

*Summer Product Engineering Workshop
in association with HYSEA and Hyderabad Hackers
with support from TS State Innovation Cell*

EXCITE is a one month summer Product Engineering/ Innovation/ Entrepreneurship workshop to Ideate, learn cutting edge skills and implement Product prototypes with the active support from Industry mentors and Startups.

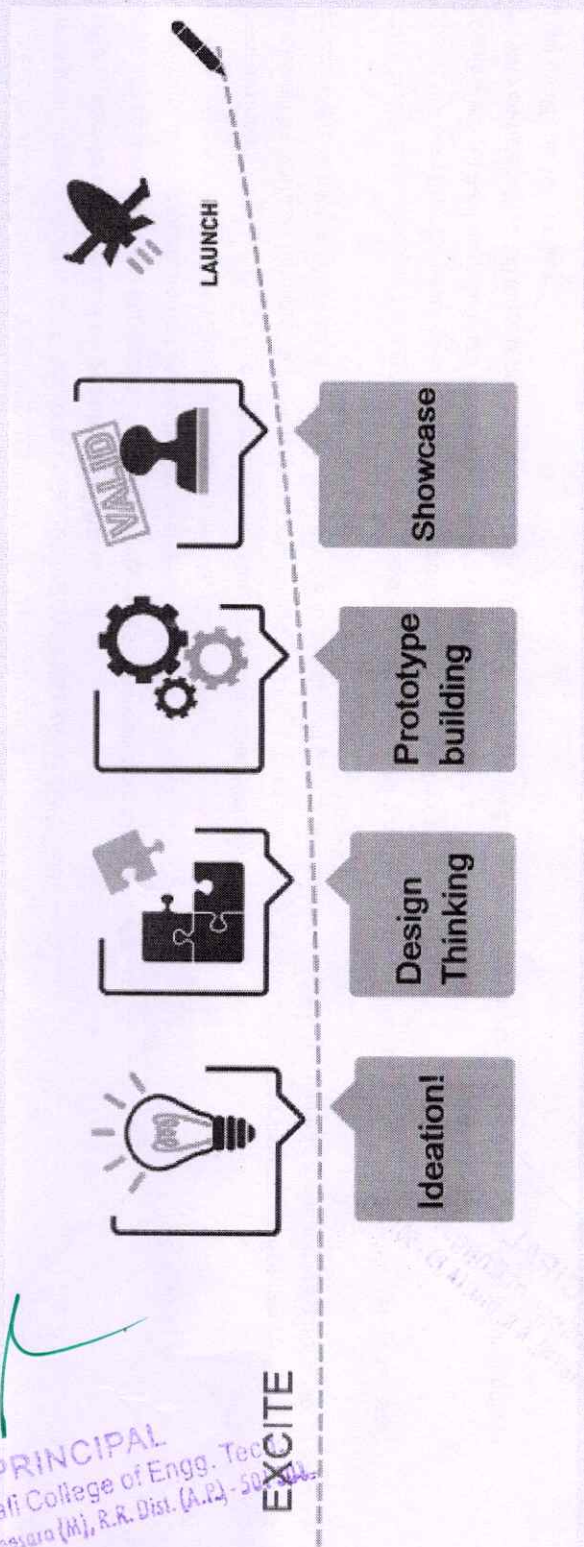
PRINCIPAL
Geethanjali College of Engg. Tech
Theerthaj (V), Kasurba (M), R.R. Dist. (A.P.) - 502 302



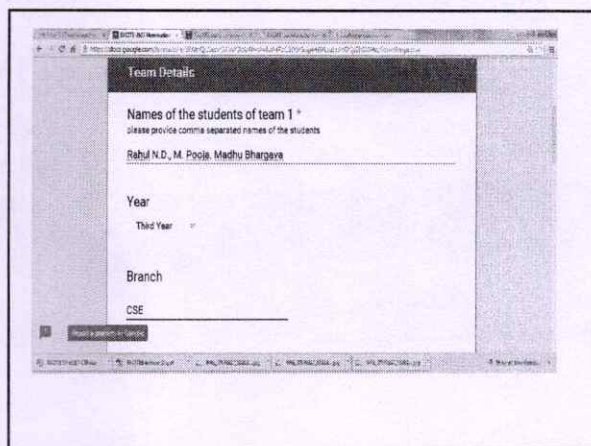
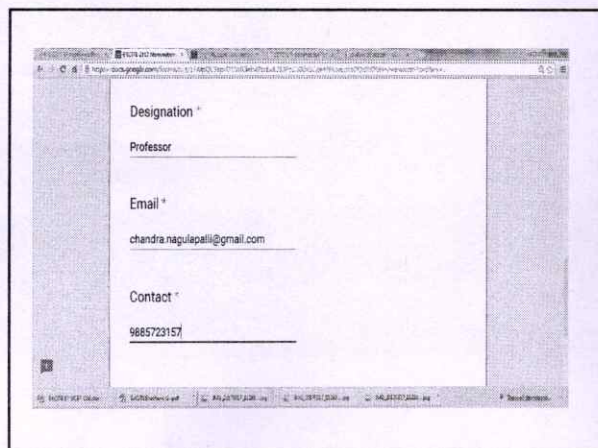
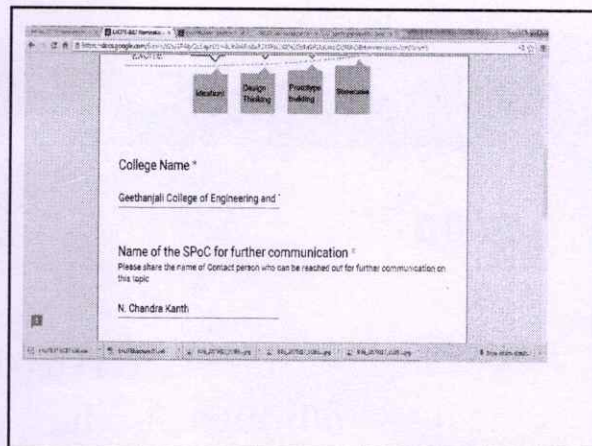
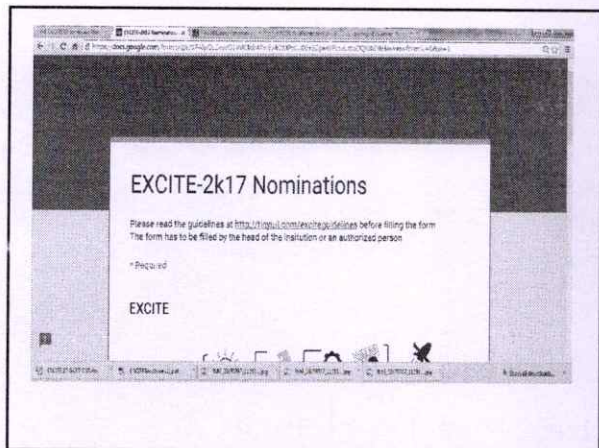

PRINCIPAL
Geethanjali College of Engg. Tech.
Chennai (W), Keesara (H), Rd. Dist. (A.P) - 501 301

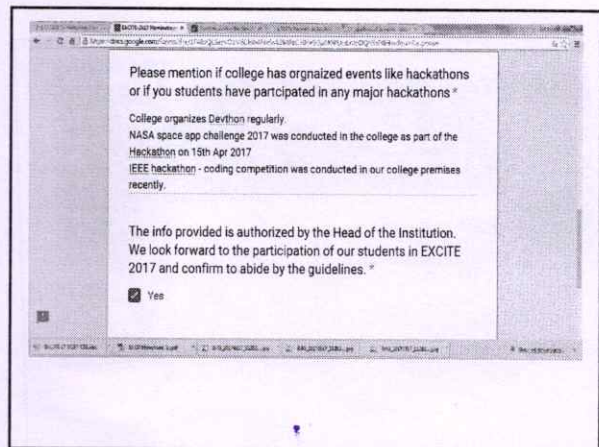
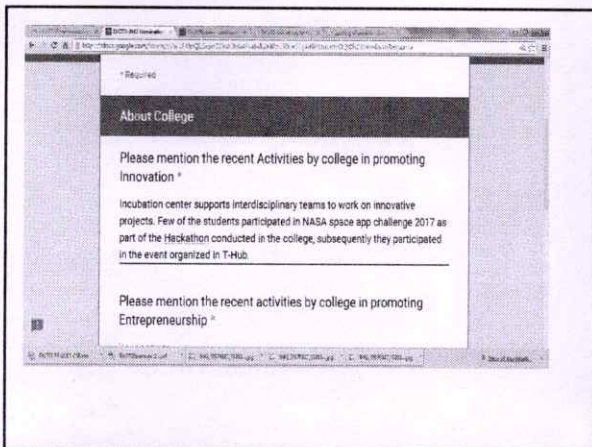
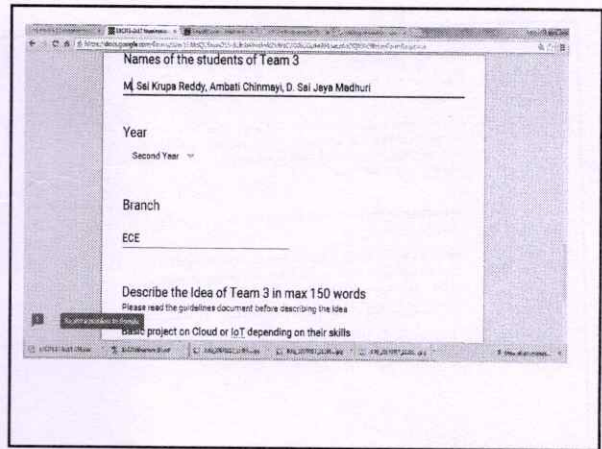
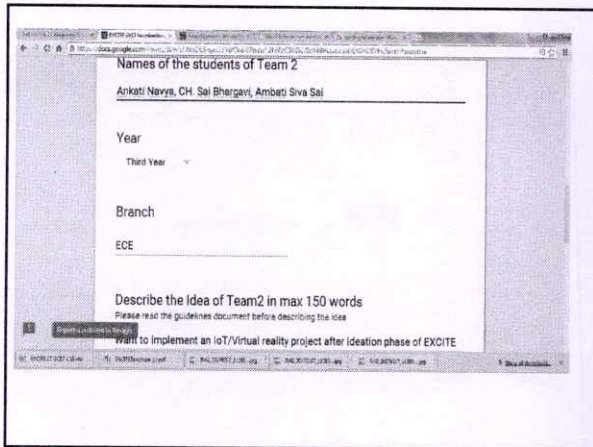

PRINCIPAL
Geethanjali College of Engg. Tech.
Cherial (V), Keosara (M), R.R. Dist. (A.R.) - 501 308



Geethanjali College of Engineering and Technology
Cheerpal(V), Keesara(M), Medchal(D)

The Geethanjali College Mobile
App Project

The Prevalent System

- The Current mode by which students acquire information relayed by the college administrators or management was through modes that remain outdated for its time.
- The Geethanjali Institutions Website and the Student-run GCTC portal have played a major role as chief distributors of information of all sorts encompassing Announcements, Results, Admin details, Placement notifications etc.
- Although they were quite efficient in their own aspects ,Students had to connect to a browser and constantly check the websites for updates which was ,needless to say, time consuming.

PRINCIPAL
Geethanjali College of Engg. Tech.
Cheerpal (V), Keesara (M), R.R. Dist. (A.P.) - 501 201

Flowchart Representation of Services

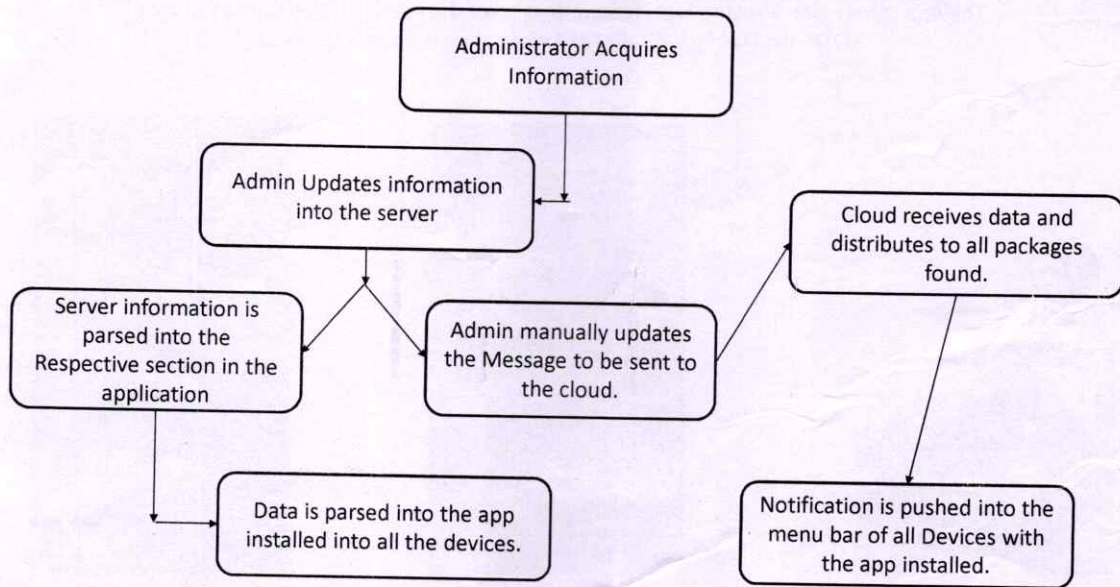

Component Diagram Representation with Data Flow

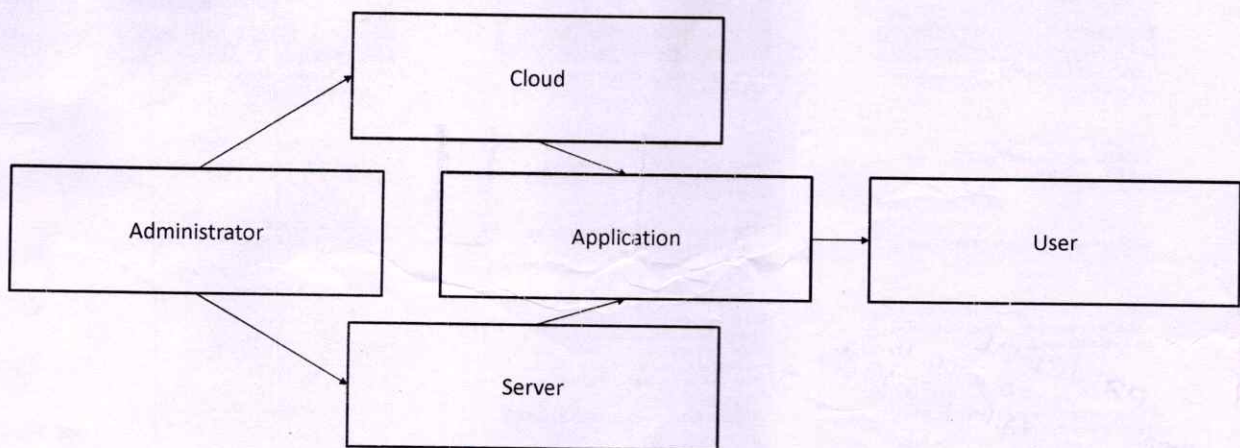

PRINCIPAL
Geethanjali College of Engg. Tech.
Cheeray (V), Keesara (M), R.R. Dist. (A.P.) - 501 301

The Navigation Drawer

The other sections of the app include segregated Portions of the announcements wherein each section could be explained as follows:

- ❖ Admin – Holds announcements made by the College Admin Section which includes Transport details, Fee Announcements and Exam notifications.
 - ❖ Attendance – Holds Attendance details. Connects to winnou.net/Geethanjali college.
 - ❖ Placements – Holds Placement Announcements.
 - ❖ Results – Holds the database of recently released results.
 - ❖ Department – Holds department specific announcements.
 - ❖ Fests – Holds Fest related announcements.
 - ❖ Sports – Holds Sports related announcements.
- ❖ Feedback section – This section is used to send a feedback on the apps performance directly to the Application developers.

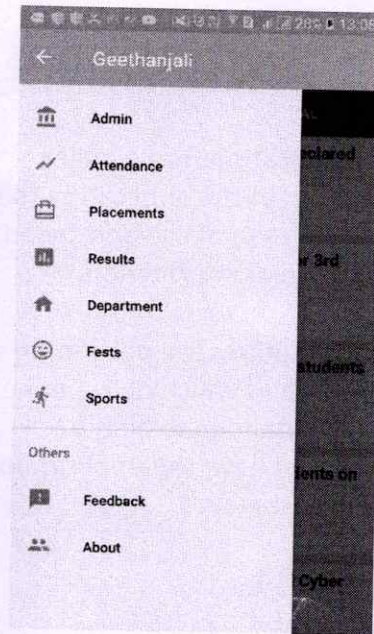

The Results tab holds the database of the recently released results which the students can assess by entering their Roll number in their specific year's tab.

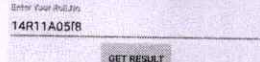
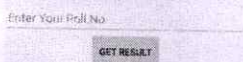

CD LAB	Marks:75
OS LAB	Marks:75
PPL	Marks:58
CD	Marks:62
CN	Marks:70
HVPE	Marks:74

CD LAB	Marks:75
Hallticket No:14R11A05F8	
Subject Code:11505	
Internal Marks:25	
External Marks:50	
Total Marks:75	
Credits:2	

PRINCIPAL
 Geethanjali College of Engg. Tech.
 Chennarayana (V), Keerasare (H), R.R. Dist. (A.P.) - 501 301

About the Developers

A Project collectively developed by,
Rahul N D - 14R11A05F6 - 9989164141
P Saiesh - 14R11A05F2 - 9640408874
I Bhavana - 14R11A05D3 - 8179573799

The Geethanjali college app Project was initiated within the IDEA INCUBATION centre of the college Headed by the **Prof N Chandrakanth**, who has been a constant support for its development, in 2015.

PRINCIPAL
Geethanjali College of Engg. Tech.
Chosryal (V), Keesara (M), R.R. Dist. (A.P.) - 501 301

List of Activities for the AY (2017-18)

Workshops/ Awareness Programs

S.No	Event	Resource Person	Organization	Target Audience	Date
1	Portal update for the students to join incubation Center	Mr. N. Chandrakanth	GCET	Students of all years and all branches	15/7/17
2	General session on Creativity and Innovation	Mr. N. Chandrakanth / Y.Phani Kishore	GCET	Students of all years and all branches	20/7/17
3	Update Sessions/Discussions	Mr. N. Chandrakanth / Y.Phani Kishore	GCET	Students of all years and all branches	27/7/17
4	Android Application Development Workshop	Mr. Durga Prasad	NSIC	Students of 2 nd , 3 rd and final years of all branches	12 to 14 August, 2017

PRINCIPAL
Geethanjali College of Engg. Tech.
Cheeruvu (V. K. R. C. Road), R.R. Dist. (A.P.) - 501 301



Geethanjali College of Engineering and Technology
(UGC Autonomous)

CHEERYAL (V), KEESARA (M) - 501301, Telangana, India

Sl. No.	Name of Project	Student Details		Status
		Name	Roll No	
Year: 2017-18				
1	Smart Li-Fi ATD	Chitneni Sai Ram Rao K.S. Veerendranath P Nikitha Reddy	15R11A0408 15R11A0483 15R11A04F6	Work In Progress
2	Smart ATD	A. Shanmukha Bruhadroop Pottabathini Tanmayi Mallakula Komal	15R11A0562 15R11A05A5 15R11A05	Work In Progress

PRINCIPAL

Geethanjali College of Engg. Tech.
Cheeryal (V), Keesara (M), R.R. Dist. (A.P.) - 501301

To

The Principal,
Geethanjali College of Engineering and Technology,
Cheeryal (V), Medchal, Hyderabad.

Date: _____

Subject: Permission to upload the Geethanjali college app into the Google Play Store.

Sir,

We the members of the Innovation Center of Geethanjali College of Engineering and Technology are glad to inform you that the testing phase of the Mobile App is nearing its end. However, to further test the app's deployment and connectivity we must buy a platform in the Google play store with the name "**GEETHANJALI INSTITUTIONS**" to distribute it to a larger student-base. To create the platform in the Google Play Store and upload the app would require a onetime payment of **25 USD**. Therefore, we kindly request you to give us permission to upload the app and proceed further with the deployment phase and reimburse the same once we upload.

Thanking you.

Yours sincerely,



Innovation Center of Geethanjali College of Engineering and Technology

Geethanjali Mobile App Development Team

Rahul N D - 14R11A05F6

P Saiesh - 14R11A05F2

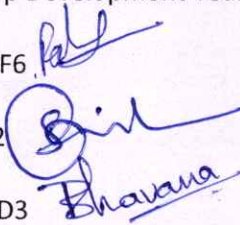
I Bhavana - 14R11A05D3



PRINCIPAL
Geethanjali College of Engg. Tech.
Cheeryal (V), Keosara (M), R.R. Dist. (A.P.) - 501 301



Geethanjali College of Engineering and Technology

CHEERYAL (V), KEESARA (M), Medchal DIST-501301, Telangana

Date: 23/2/2018

To,
The Accounts Officer,
GCET

Respected Sir,

Secretary sir has approved a sum of Rs. 15000.00 (Fifteen thousand only) for renewal of domain for Geethanjali App.

As discussed with you we have renewed the same using the credit card for Rs. 11,976.00 (Eleven Thousand Nine hundred and Seventy Six only). I request you to please reimburse this amount.

Attached:

1. Bill for 11,976.00 from hostinger
2. Copy of approval letter from Principal and Secretary Sir.

Thanking you sir,

Regards,

N. Chandrakanth
Dept of CSE, GCET

PRINCIPAL
Geethanjali College of Engg. Tech
Cheeryal (V), Keesara (M), R.R. Dist. (A.P.) - 501 301

Geethanjali College of Engineering and Technology

CHEERYAL (V), KEESARA (M), R.R.DIST-501301, Telangana

Date: 17/4/2017

To,
The Principal,
GCET, Cheeryal.

Respected Sir,

As per the direction from the management of GCET, we have created an account in google play store for our students to upload any apps they create under GCET banner. There is a onetime charge by Google for an amount of USD 25. We have paid the same in INR 1705.00 via credit card. I request you to please approve the reimbursement of the same.

I am enclosing the Credit card bill for your reference.

Thanks and Regards

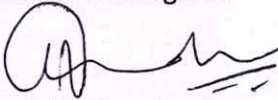

Prof. N. Chandrakanth
Dept. of CSE,
GCET

To
A/c for on.a.pl

Sd/-
17/04/17

by
NA

PRINCIPAL
Geethanjali College of Engg. Tech.
Cheeryal (V), Keesara (M), R.R. Dist. (A.P.) - 501 301



Geethanjali College of Engineering and Technology
(UGC Autonomous)

CHEERYAL (V), KEESARA (M) - 501301, Telangana

Date: 16/02/2018

To,

The Principal,
Geethanjali College of Engineering and Technology,
Cheeryal (V), Keesara (M), Medchal Dist.
Telanagana State – 501301

Respected Sir,

Sub: Renewal of Domain for Geethanjali Apps

Our College has been running Geethanjali College App on the servers of (GoDADDY) which is about to expire in the month of March, 2018.

We are planning to renew this for 2 years rather than one year. Approximate cost of the renewal would be Rs. 15,000.00 (Rs. Fifteen Thousand Only).

We request you to kindly approve this renewal, to enable smooth functioning of the app.

Regards



16/2/18

Prof. N. Chandrakanth

16/2/18

Y.V.N. Phanikishore

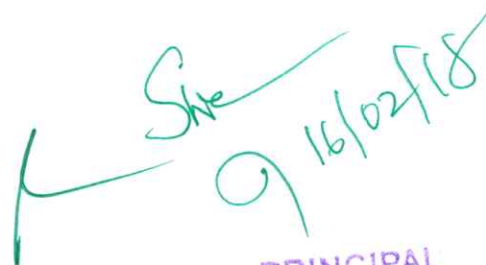

16/02/18

PRINCIPAL
Geethanjali College of Engg. Tech.
Cheeryal (V), Keesara (M), R.R. Dist. (A.P.) - 501301

GEETHANJALI COLLEGE OF ENGINEERING AND TECHNOLOGY

EXCITE STUDENT LIST 2017 - 2018

S.No	Name	Roll No	Branch	Phone	Email
1	Chitneni Sai Ram Rao	15R11A0408	ECE III	7075653264	sairamrao96@gmail.com
2	K S VEERENDERNATH	15R11A0483	ECE III	8520054854	veerendernathkomala@gmail.com
3	P. Nikitha Reddy	15R11A04F6	ECE III	9515593517	nikithareddy1227@gmail.com
4	A. Shanmukha Bruhadroop	15R11A0562	CSE III	8125055580	adepalli.bruha@gmail.com
5	Pottabathini Tanmayi	15R11A05A5	CSE III	9618706487	tanmayi.pottabathini13@gmail.com
6	Mallakula Komal	15R11A05	CSE III	9703814040	kmallakula@gmail.com

PRINCIPAL
 Geethanjali College of Engg. Tech.
 Cheeryal (V), Keesara (M), R.R. Dist. (A.P.) - 501 301



[Handwritten signature]
PRINCIPAL
Geethanjali College of Engg. Tech.
Cheeryal (V), Keesara (M), R.R. Dist. (A.P.) - 501 301



PRINCIPAL
Geethanjali College of Engg. Tech.
Cheerpal (V), Kessara (M), R.R. Dist. (A.P.) - 501 301

Sl No.	Name of the College	Name of the Team Member_1	Signature	Name of the Team Member_2	Signature	Name of the Team Member_3	Signature
A3 (13)	CVSR	Akkanathu Raju Reddy	<i>[Signature]</i>	Chandra Prakash	<i>[Signature]</i>	Asma	<i>[Signature]</i>
A6 (14)	CVR	Tannayen Kodumagula	<i>[Signature]</i>	B Saadhika	<i>[Signature]</i>	Ch. Sangeetha Reddy	<i>[Signature]</i>
A7 (15)	CVR	P VIVEK TEJA	<i>[Signature]</i>	SURAJ RAMADUGU	<i>[Signature]</i>	AVINASH KANGARI	<i>[Signature]</i>
A5 (16)	CVR	M Pruthi Raj Reddy	<i>[Signature]</i>	Adepu Rohith	<i>[Signature]</i>	K Prasad	<i>[Signature]</i>
	CVSR	T NAVEEN	<i>[Signature]</i>	M DANUSH	<i>[Signature]</i>	T ESHWAR	<i>[Signature]</i>
A19 (18)	CVSR	N Uthaj Kumar	<i>[Signature]</i>	Sumanth A	<i>[Signature]</i>	V Ashish	<i>[Signature]</i>
A2 (19)	CVSR	Ashish	<i>[Signature]</i>	Manorama Upachayay	<i>[Signature]</i>	Suchatha Reddy	<i>[Signature]</i>
A4 (20)	Geethanjali	Chitneni Sri Ram Rao	<i>[Signature]</i>	K.S Veerenderaiah	<i>[Signature]</i>	P Nikitha reddy	<i>[Signature]</i>
A12 (21)	Geethanjali	A Sharmukha Brihadnaga	<i>[Signature]</i>	Pottabathini Tanmayi	<i>[Signature]</i>	Malakula Komal	<i>[Signature]</i>
A15 (22)	GNITS	Swathi Pratapa	<i>[Signature]</i>	Reethu Priya A	<i>[Signature]</i>	Reddyvan Sreya	<i>[Signature]</i>
	ORIET	Shehzad Qaiser	<i>[Signature]</i>	Salman Khan	<i>[Signature]</i>	Shounak Chatterjee	<i>[Signature]</i>
A18 (23)	ORIET	TISHANT GHOLE	<i>[Signature]</i>	TALARI KUSUMA	<i>[Signature]</i>	M. SHRUTHI	<i>[Signature]</i>
	ORIET	Y.Bharath	<i>[Signature]</i>	M Subash	<i>[Signature]</i>	A Siva Nagaraju	<i>[Signature]</i>

PRINCIPAL
 Geethanjali College of Engg. Tech.
 Cheeryal (V), Kaesara (M), R.R. Dist. (A.P.) - 501 301



[Handwritten signature]

PRINCIPAL
Geethanjali College of Engg. Tech.
Cheerayal (V), Keesara (M), R.R. Dist. (A.P.) - 501 301



PRINCIPAL
Geethanjali College of Engg. Tech.
K. R. D. Dist. (A.P.) - 501 301

GEETHANJALI COLLEGE OF ENGINEERING AND TECHNOLOGY

EXCITE STUDENT LIST 2017 - 2018

S.No	Name	Roll No	Branch	Phone	Email
1	Chitneni Sai Ram Rao	15R11A0408	ECE III	7075653264	sairamrao96@gmail.com
2	K S VEERENDERNATH	15R11A0483	ECE III	8520054854	veerendernathkomala@gmail.com
3	P. Nikitha Reddy	15R11A04F6	ECE III	9515593517	nikithareddy1227@gmail.com
4	A. Shanmukha Bruhadroop		CSE III	8125055580	adepalli.bruha@gmail.com
5	Pottabathini Tanmayi		CSE III	9618706487	tanmayi.pottabathini13@gmail.com
6	Mallakula Komal		CSE III	9703814040	kmallakula@gmail.com

PRINCIPAL
 Geethanjali College of Engg. Tech.
 Cheerayal (V), Kousaram (M), R.R. Dist. (A.P.) - 501 301

EXUTE-2018

P. Nikitha Reddy	15R11A04F6	9515593517	nikiithareddy1227@gmail.com
			ECE-3C
K.S. Veerendernath	15R11A0483	8520054854	Veerendernath Komala@gmail.com
			ECE-3B
Ch. Sai Ram Rao	15R11A0408	7075653264	Sairamrao96@gmail.com
			ECE-3A
A.S. Bruhadroop	15R11A0562	9292955581	addepalli.bruha@gmail.com
			CSE-3B.
P. Tanmayi	15R11A05A5	9618706487	tanmayi.pottabattini13@gmail.com
			CSE-3B
M. Komal	15R11A0589	9703814040	kmallakula@gmail.com
			CSE-3B.

PRINCIPAL
Geethanjali College of Engg. Tech.
Cheerla (P), Kovvur (M), K.R. Dist. (A.P.) - 501301

3/3/18

1. Stumagz - com

- design for college / student logos.
- Articles / Events from Stumagz can be updated to JHUB magazine
- Can check activities of other colleges
- All events/etc --- to be put under "Innovation" tab
- Keywords "JHub", "Jlabs", "GCET"

2. Registrations for JHUB

- Posters & etc. ---
- Prepare for Contest
- Faculty can come by
- Training for faculty.
- Panel of Experts

- Double ideas for Hackathons
- idea to proof-of-concept
- Come with ideas / areas
- feed back

NeN - BVC

Hackathon - investor ready

- feasibility / Market demand
- some metrics (revenue, sales target etc. ---)

- Inline with Smart India Hackathon

PRINCIPAL
Geethanjali Coll.

2/2

5th May 2018

JHUB - Excite Kick-off Meeting

1. Excite program project to be realized as products.
Push for better than just Mini-projects.

2. May 17th to June 30th.

- Prepared with Assignments. (Pre-workshop assignments)
- Reviewed by expert panel.

- Open Hackathons @ colleges

= 13th to 21st May - Certain Review

= from 21st we work on product.

your story. your
entrepreneur daily.

→ Boot Camp - 14 days. May 28th to June 8th
(2nd Year) - Prize.

{ Process Bee → company
{ Venture Write - Game.

Venture Voyage →

- E-cub talk daily

PRINCIPAL
Geethanjali College of Engg & Tech.
Cheeruvu (M), K.R. Dist. (A.P.) - 501 304

Pre-Assignment for EXCITE → what problem does it solve?

① - Problem validation (Identification) + How big? Identification of real problem

② - Who has this problem? (Market) at least 3 to 4 segments

③ - How unique is the solution?

④ - Defense against the competition. (competition analysis)

⑤ - Infrastructure.

Attendees:-

- 1) Dr. Vijaya Kumari (JNTUH)
- 2) Ramesh Loganathan (IIIrd Hyd)
- 3) Pampaj (idealabs)

4. Chandukarth (GCET)

5. Phanikiran (GCET)

&

SPOCs from various colleges



Yvn Phanikishore <yvnphanikishore@gmail.com>

Second meeting with Institute Coordinator - 03/03/2018

4 messages

JNT UNIVERSITY HYDERABAD <jhub@jntuh.ac.in> Mon, Feb 26, 2018 at 1:04 PM
 To: vijaya saradhi <meduri_vsd@yahoo.co.in>, KANNARAO SHATARASI <skr2ece2ace@gmail.com>, Rajitha Reddy <rajitha.reddy87@gmail.com>, ramanareddy.a@bvrithyderabad.edu.in, priyakanth.r@bvrithyderabad.edu.in, madhavi.r@bvrithyderabad.edu.in, anilkumar.y@bvrithyderabad.edu.in, padmavati.e@bvrithyderabad.edu.in, guruswamy.r@bvrithyderabad.edu.in, cvr placement <cvr.placement@gmail.com>, placement@cvr.ac.in, vishnuvandanamba@cvsr.ac.in, kumarneerajece@cvsr.ac.in, Chandra Nagulapalli <chandra.nagulapalli@gmail.com>, ogirala.sivakumar@gmail.com, info@gcet.edu.in, Harish Pulluri <harishpulluri210@gmail.com>, Yvn Phanikishore <yvnphanikishore@gmail.com>, Principal Gnits <principal@gnits.ac.in>, S Ramacharan <s.ramacharan@gmail.com>, malini devi <gmalini12@gmail.com>, kalyani_nara@rediffmail.com, lalitha smiley <lalitha.malla@gmail.com>, Jeevan Nag <jeevannagendra@gmail.com>, pradeepreddygriet@gmail.com, Kits Kmm <kits.kmm@gmail.com>, m v N MARUTI <amvnmaruti@gmail.com>, sreevani@mgit.ac.in, Vijay Kumar Damera <dameravijaykumar@gmail.com>, ramesh.me@nmrec.edu.in, krishna pagidimarri <pagidimarrik@gmail.com>, Principal Sphoorthy <principal.sphoorthy@gmail.com>, Pavan Kumar Katkuri <pavankumarkatkuri@gmail.com>, principal@sreenidhi.edu.in, "Dr. Ameet Chavan" <ameetchavan@sreenidhi.edu.in>, Sundaragiri Dheeraj <dheerajs@sreenidhi.edu.in>, smec2002principal@gmail.com, Gopi Krishna Saramekala <gopi.saramekala@gmail.com>, hodmba@smec.ac.in, sai krrish mskmurthy1003@gmail.com, Dr Padmaja M <principalvjit@vjit.ac.in>, siddhartha@vjit.ac.in, Goutham Mannava <goutham_s_mannava@hotmail.com>, madan 324 <madan324@gmail.com>, Arun Ganji <arun.ganji@gmail.com>, Placements Vbit <placementofficer.vbit@gmail.com>, narayanarao_svn@vnrvjiet.in, S V S S SRINIVASA RAJU <svssraju@gmail.com>, swetha.perumalla1@gmail.com, vijaya Lode <vijayalode@gmail.com>

Dear Sir/Madam.

Greetings from JHUB.

The second meeting of the Institution Coordinators is scheduled on March 3rd, 2018 at 10:30am at JHUB , 1st floor Admission block JNTUH campus.

The agenda of the meeting is as follows:

1. Brief 2-3 slide presentation of coordinators about the activities organized for 2nd year students and Best practices on Innovation and Entrepreneurship at the institute.
2. Brain storming on topics for technical workshops to be conducted for students during March 2018.
3. SPoC training programmes.

The meeting shall conclude by 1pm and will be followed by lunch.

Kindly confirm the name of the SPoC attending the meeting to make logistic arrangements.

Regards...

Dr. G. Vijayakumari
 Director of J-HUB
 JNTUH.

PRINCIPAL
 Gouthanjali College of Engg. Tech.
 Cheerl (V), Anaparthi (M), R.R. Dist. (A.P.)

Chandra Nagulapalli <chandra.nagulapalli@gmail.com> Tue, Feb 27, 2018 at 11:43 AM
 To: JNT UNIVERSITY HYDERABAD <jhub@jntuh.ac.in>
 Cc: Yvn Phanikishore <yvnphanikishore@gmail.com>, Udaya Susarla <uksusarla@gmail.com>

5/31/2018



Yvn Phanikishore <yvnphanikishore@gmail.com>

Phase-II Selection List for Bootcamp and Hackathon

2 messages

Wed, Feb 21, 2018 at 1:24 PM

JNT UNIVERSITY HYDERABAD <jhub@jntuh.ac.in>

To: vijaya saradhi <meduri_vsd@yahoo.co.in>, KANNARAO SHATARASI <skr2ece2ace@gmail.com>, Rajitha Reddy <rajitha.reddy87@gmail.com>, ramanareddy.a@bvrithyderabad.edu.in, priyakanth.r@bvrithyderabad.edu.in, madhavi.r@bvrithyderabad.edu.in, anilkumar.y@bvrithyderabad.edu.in, padmavati.e@bvrithyderabad.edu.in, guruswamy.r@bvrithyderabad.edu.in, cvr placement <cvr.placement@gmail.com>, placement@cvr.ac.in, vishnuvandanamba@cvr.ac.in, kumarneerajece@cvr.ac.in, Chandra Nagulapalli <chandra.nagulapalli@gmail.com>, ogirala.sivakumar@gmail.com, info@gcet.edu.in, Harish Pulluri <harishpulluri210@gmail.com>, Yvn Phanikishore <yvnphanikishore@gmail.com>, Principal Gnits <principal@gnits.ac.in>, S Ramacharan <s.ramacharan@gmail.com>, rajkumar_lb2@yahoo.com, malini devi <gmalini12@gmail.com>, kalyani_nara@rediffmail.com, lalitha smiley <lalitha.malla@gmail.com>, Jeevan Nag <jeevannagendra@gmail.com>, pradeepreddygriet@gmail.com, Kits Kmm <kits.kmm@gmail.com>, m v N MARUTI <amvnmuruti@gmail.com>, sreevani@mgit.ac.in, Vijay Kumar Damera <dameravijaykumar@gmail.com>, ramesh.me@nmrec.edu.in, krishna pagidimarri <pagidimarrik@gmail.com>, Principal Sphoorthy <principal.sphoorthy@gmail.com>, Pavan Kumar Katkuri <pavankumarkatkuri@gmail.com>, principal@sreenidhi.edu.in, "Dr. Ameet Chavan" <ameetchavan@sreenidhi.edu.in>, Sundaragiri Dheeraj <dheerajs@sreenidhi.edu.in>, smec2002principal@gmail.com, Gopi Krishna Saramekala <gopi.saramekala@gmail.com>, hamba@smec.ac.in, sai krish <mskmurthy1003@gmail.com>, Dr Padmaja M <principalvjit@vjit.ac.in>, siddhartha@vjit.ac.in, Goutham Mannava <goutham_s_mannava@hotmail.com>, madan 324 <madan324@gmail.com>, Arun Ganji <arun.ganji@gmail.com>, Placements Vbit <placementofficer.vbit@gmail.com>, narayanarao_svn@vnrvjiet.in, S V S SRINIVASA RAJU <svssraju@gmail.com>, principal_ceh <principal.ceh@jntuh.ac.in>, "Dr. K.P. Supreethi" <supreethi.pujari@jntuh.ac.in>, Dr N V Ramana <nvrjntu@jntuh.ac.in>, Suresh Kumar <sureshsanampudi@gmail.com>, swetha.perumalla1@gmail.com, "Dr. R. Markhandeya" <marksravvala@jntuh.ac.in>, "Dr. B.Vishnu Vardhan" <mailvishnu@jntuh.ac.in>, "Dr. Shahu Chatrapati" <shahujntu@jntuh.ac.in>, Shahu Chatrapati <shahujntu@gmail.com>, Principal Jntuhces <principaljntuhces@jntuh.ac.in>, narsimha Gugulothu <narsimha06@gmail.com>

Dear Sir/Madam

The following ideas have been shortlisted for mentoring and further refinement during the central Hackathon on 23-24 Feb 2018. Feasible ideas after mentoring will be participating in the Hackathon. The students are therefore informed to report at 9 AM on Feb23rd, 2018 at JHUB, along with ppt of their ideas and laptops and other hardware required.

Regards...

Dr. G. Vijayakumari
Director of J-HUB
JNTUH.

PRINCIPAL
Geethanjali College of Engg. Tech.
Cheerla (V), Keeravani (M), R.R. Dist. (A.P.) - 501 301

Phase2-Idea_Mentoring_Finalized_List_21-02-2018.pdf
19K

JNT UNIVERSITY HYDERABAD <jhub@jntuh.ac.in>

Wed, Feb 21, 2018 at 1:30 PM

To: vijaya saradhi <meduri_vsd@yahoo.co.in>, KANNARAO SHATARASI <skr2ece2ace@gmail.com>, Rajitha Reddy <rajitha.reddy87@gmail.com>, ramanareddy.a@bvrithyderabad.edu.in, priyakanth.r@bvrithyderabad.edu.in, madhavi.r@bvrithyderabad.edu.in, anilkumar.y@bvrithyderabad.edu.in, padmavati.e@bvrithyderabad.edu.in, guruswamy.r@bvrithyderabad.edu.in, cvr placement <cvr.placement@gmail.com>, placement@cvr.ac.in, vishnuvandanamba@cvr.ac.in, kumarneerajece@cvr.ac.in, Chandra Nagulapalli <chandra.nagulapalli@gmail.com>, ogirala.sivakumar@gmail.com, info@gcet.edu.in, Harish Pulluri <harishpulluri210@gmail.com>, Yvn Phanikishore <yvnphanikishore@gmail.com>, Principal Gnits <principal@gnits.ac.in>, S Ramacharan <s.ramacharan@gmail.com>, rajkumar_lb2@yahoo.com, malini devi <gmalini12@gmail.com>, kalyani_nara@rediffmail.com, lalitha smiley <lalitha.malla@gmail.com>, Jeevan Nag <jeevannagendra@gmail.com>, pradeepreddygriet@gmail.com, Kits Kmm

https://mail.google.com/mail/u/0/?ui=2&ik=0c6e1d5ee0&jsver=-dxVnc9Y02g.en.&cbl=gmail_fe_180516.06_p8&view=pt&q=jhub&qs=true&search=query&th=

Name	email	Phone	Name of College
Saipranav Koyyada	ksaipranav@gmail.com	9542739065	JNTUHCEH
k.n.madhu sudhan	madhusudhan5a9@gmail.	9515875592	ACE ENGINEERING COLLEGE
MOHAMMED TAHA MINA	tminam1998@gmail.com	7382171707	JNTU-Manthani
Sai Phani Krishna	saiphani.krishna1@gmail.c	8885217915	JNTUHCEH
A.CHARISHMA	16wh1a0402@bvrithydera	9390597707	Bvrit Hyderabad college of engineering for women
B. Priya Rajan	bandela.priyaranjan09@gm	7337499779	GNITS
vijaylaxmi,Hemang vellore	lendalevijaylaxmi.97@gma	9182699483	Anurag group of institutions (cvsr)
Praveena sidgar	praveena.sidgar@gmail.co	8500481317	JNTUCES
Shounak Chaterjee	shounak.chatterjee97@gm	9908142041	GRIET
Nandini	Chamarthinandini1210@g	8464048112	Abhinav Hitech College of Engineering
ABHISHEK B	abhishekb95@yahoo.com	8341494737	MGIT
T.VINOD KUMAR REDDY	vinodreddy9705378864@g	9182976145	GRIET
Aleemuddin	syedaleem12197@gmail.c	9704048825	JNTUHCEH
VFRIEND	nidhimn2811@gmail.com.	9705396910	GEETHANJALI COLLEGE OF ENGINEERING AND TECHNOLOGY
M Roshini	15wh1a0249@bvrithydera	9493329938	Bvrit Hyderabad college of engineering for women
kommidi navya sai	kommidinavyareddy@gma	7893501862	SPHOORTHY ENGINEERING COLLEGE
K.CHARITHA	charitha.cherry906@gmail	7032357523	SPHOORTHY ENGINEERING COLLEGE
N Prathul Sai	npsgoud@gmail.com	8790044828	JNTU-Manthani
B.Manisha	manishabejugam9@gmail	8008009804	GNITS
Sampelli siri	sampellysiri127@gmail.co	9492011073	GNITS

Geethanjali College of Engg. Techn

PRINCIPAL
 Geethanjali College of Engg. Techn
 Hyderabad (H), R.R. Dist (A)

Submission number	Name	email	Phone	Name of College	What Industry /domain does your idea best represent	Describe your idea in less than 100 words
1	K.Ramya Sai	ramyasai08@gmail.com	8977026440	ACE ENGINEERING COLLEGE	Industrial IOT	A technique is developed to detect manhole covers on the streets. Vehicles on the road have a great impact on the cover detection rate. Using this we can cover the manholes with lid by the arrival of vehicles and we can detect them during floods with signal and inform to municipal office.
12	ROHITH KUMAR KATTA	RROYAL.RK@GMAIL.COM	+919399996636	GRIET	IOT (INTERNET OF THINGS)	The problems that facing by the farmers by natural calamities like floods, THUNDERS, Etc. That which causes most Damages to there life. For that cause we making a device that can work it self without being the farmer. It saves the Electronic device from the Burning, its works like farmer ROBOT.
13	Ganesh Srivatsa Kalahasti	gani.victory@gmail.com	8074592538	ACE ENGINEERING COLLEGE	Medical Monitoring	The main objective of my idea is to keep the human Blood pressure (BP), heart functioning and happening of hypoglycemia being monitored constantly and detect it's abnormality.
15	K Madhumitha Reddy	madhur_rithareddyk@gmail.com	8801090012	JNTUHCHEH	Robotics	The HEART of any ROBOTIC ENTITY is the proper control of the DC motors. We intend to create an intelligent cleaning robot: which once installed does not need any human monitoring. In this way, one does not have to bother about switching on the robot everyday and be able to keep the surroundings neat.

PRINCIPAL
Geethanjali College of Engg. Tech.
Cheeroyal (V), Keerthi (M), N.R. Dist. (A.P.) - 501306

27	G. Prashanth Kumar	prashanth013196@gmail.com	9700847600	GEETHANJALI COLLEGE OF ENGINEERING AND TECHNOLOGY	Medical Monitoring System	In India due to traffic signaling system and various other reasons ambulances are getting late, which results in loss of lives! To this purpose, an advanced traffic signaling system is proposed that is capable of detecting the ambulance from far area and clear the traffic according to the need.
31	ROHAN MAJUMDAR	rhmjmdr669@gmail.com	8333802747	JNTU-JAGTYAL	Medical Monitoring System	Constantly monitoring the patient's Heart beat, Blood Pressure and Temperature from a smart wearable using Bluetooth sensor from the watch. The system will be trained by Anomaly Detection Algorithm by which any anomaly(exceptions) will be detected and alerted to nearest hospital.
33	K.Abhiram Varma	abhiram040@gmail.com	9849558075	GRIET	INDUSTRIAL IOT	Temperature, humidity control had become a major challenge. Our idea is to monitor the industrial temperature and humidity in industries and also use a smart water coolant pumping for machinery. We use two temperature sensors namely DHT11 and DS18B20. Data is pushed to cloud using MQTT protocol.
35	BHARATH KUMAR GOUD SATHURI	sathuribharathbrothers1234@gmail.com	91333430813	Sreenidhi Institute of Science and Technology	Computer Science & Engineering/Natural Language Processing	There is no existing software for generating subtitles for a live video. We are trying to develop a software which generates subtitles for a live video by taking the audio from speech and sending them to cloud to get the text by using speech to text and sending text to broadcasting centers to telecast.



Geethanjali College of Engineering and Technology

(UGC Autonomous)

CHEERYAL (V), KEESARA (M), Medchal Dist. - 501301, Telangana

Date: 16-12-2017

Circular

Respected Coordinators,

We have to plan the activities for the "Center for Innovation and Creativity" and the same for "i-cell". Please attend the meeting on 19-12-2017 at 3:10 PM, in the CSE Dept Seminar hall. Please attend without fail and come on time.

Agenda:

1. Schedule of Activities for Sem II – AY 2017-18 (Both Incubation and EDC)
2. Plan for Hackathon in January 2018
3. Student nominations





Thanks and Regards:

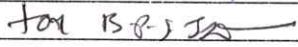

Prof. N. Chandrakanth
Coordinator i-cell

Geethanjali College of Engineering and Technology

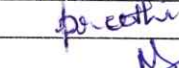
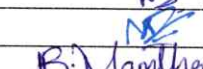
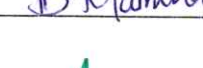
Copy to:

Sl.No.	Name	Dept.	Signature
1	Prof. Siva Kumar Ogirala	ECE	
2	Dr. Sita Madhavi	MBA	
3	Y.V.N. Phani Kishore	CSE	
4	Preeti Prasada	CSE	
5	P. Harish	EEE	
6	B. Subba Rao	ME	
7	Y. Rajesh Kumar	CE	

PRINCIPAL
Geethanjali College of Engg. Tech.
Cheeryal (V), Keesara (M), R.R. Dist. (A.P.) - 501301



**Geethanjali College of Engineering and
Technology
(UGC Autonomous)**

CHEERYAL (V), KEESARA (M) - 501301, Telangana

Date: 13-9-2017

Respected Coordinators,

In continuation to the circular sent by Principal Sir earlier this month, we will have our first meeting on 14th Sept 2017 at 12:30 PM (Thursday) in CSE Lab 5 (2nd floor Block 1). The agenda of the meeting is as follows

1. Constituent of i-cell
2. Roles and Responsibilities
 - a. Incubation/Innovation
 - b. Industry Interaction
 - c. Entrepreneur Development
3. Schedule of activities

Thanks and Regards

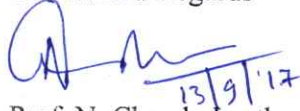
13/9/17







Prof. N. Chandrakanth
Coordinator i-cell

Geethanjali College of Engineering and Technology

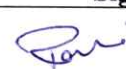
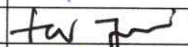
PRINCIPAL

Geethanjali College of Engg. Tech.
Cheeryal (V), Keesara (M), R.R. Dist. (A.P.) - 501 301

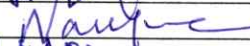
Copy to:

Sl.No.	Name	Dept.	Signature
1	Prof. Siva Kumar Ogirala	ECE	
2	Dr. Sita Madhavi	MBA	
3	Y.V.N. Phani Kishore	CSE	
4	Preeti Prasada	CSE	
5	P. Harish	EEE	
6	B. Subba Rao	ME	
7	Y. Rajesh Kumar	CE	

988 231 8166 - Harish EEE



Chandra Nagulapalli <chandra.nagulapalli@gmail.com>

Central Hackathon Idea submission

1 message

jhub.jntuh <jhub.jntuh@gmail.com>
To: j-hub-SPoCs <j-hub-spocs@googlegroups.com>

Tue, Feb 13, 2018 at 9:22 AM

Dear SPoCs,

Thank you for the overwhelming response to the submission of ideas by your students for the central hackathon. we have received more than 200 ideas. A panel of mentors shall validate and shortlist the ideas based on the relevance of theme (Cyber-Physical Systems), uniqueness and novelty of Idea and other relevant parameters.

The shortlisted teams will be intimated by Thursday morning. Teams which are shortlisted are invited to participate in a two-day bootcamp on IoT with LoRa Technologies at JNTUH campus on Friday and Saturday (16th -17th Feb). The bootcamp shall help to enhance the practical knowledge of students by giving them hands-on learning experience and further refine their ideas for Hackathon

More detailed inputs on inventory that students should carry for the bootcamp and detailed instructions will be mailed shortly.

any queries, feel free to mail at info@j-hub.in

regards
Team J-Hub

--

You received this message because you are subscribed to the Google Groups "j-hub-SPoCs" group.

To unsubscribe from this group and stop receiving emails from it, send an email to j-hub-spocs+unsubscribe@googlegroups.com.

To post to this group, send email to j-hub-spocs@googlegroups.com.

To view this discussion on the web visit <https://groups.google.com/d/msgid/j-hub-spocs/cdf5e4f2-787f-4213-8afb-d2cde881dfff%40googlegroups.com>.

For more options, visit <https://groups.google.com/d/optout>.

PRINCIPAL
Geethanjali College of Engg. Techn.
(Autonomous), Koppal (A), R.R. Dist. (A.P.) - 501 201

Sno	Name of college	no of entries	Complete Presentation
1	Abhinav Hitec	2	2
2	ACE	23	17
3	Anurag Group of Instituti	14	3
4	BVRITH	11	7
5	Geethanjali	5	3
6	GNITS	8	7
7	GRIET	29	18
8	JNTUCES	4	4
9	JNTUCEH	17	14
10	JNTU-Jagatiyal	6	5
11	JNTU-Manthani	14	10
12	KITS-Khammam	2	2
13	MGIT	3	2
14	Sphoorthy	43	30
15	SNIST	6	5
16	Vidya Jyoti	2	1
17	blank	1	1
		190	131

PRINCIPAL
 Geethanjali College of Engg. Techn.
 Cheeraj (V), Keesara (M), R.R. Dist. (A.P.) - 507 301

SPoC Orientation program Jhub:Jlabs JNTUH Innovation Hub



Feb 2 2018

Jhub: Central hackathon CYBERPHYSICAL SYSTEMS and INDUSTRY 4.0

IMPORTANT DATES:

- > Idea submission Feb 10
- > Registration form www.jntuh.ac.in/jhubhack
- > Shortlisting Feb 12
- > Inventory list Feb 12
- > Deep Dive Boot Camp on Cyber physical systems - industrial IoT Feb 16-17
- > Hackathon Feb 23-24

Cyber Physical Systems

Theme: Cyber Physical Systems – Industry 4.0

A cyber-physical system (CPS) is a mechanism that is controlled or monitored by computer-based algorithms, tightly integrated with the Internet and its users.

Examples of CPS include

- Smart grid
- Autonomous automobile systems
- Medical monitoring
- Process control systems
- Robotics systems
- Automatic pilot avionics
- Industrial IoT

IoT –LoRa
EDGE computing
AI
ML
AR/VR
Drones

Launch of Jhub:Jlabs JNTUH Innovation Hub



College Registration Guidelines
Feb 2 2018

Objective: Innovation

- Excitement around innovation
 - Exposure (UG) to interesting products & startups
 - Teaser workshops & seminars
- Create a culture of “building” tech prototypes
 - Ideation, Experimentation, Prototypes
- Create tech product based startups
 - Idea thru Prototypes
- Hub and Spoke model
 - Central Hub at Univ campus (Jhub)
 - College level spokes (Jlabs)
 - Students & team from college level, get help from central Jhub
- Jhub will connect with T-Hub, State Innovation Cell and other city enablers

CREATING A CULTURE OF
INNOVATION ACROSS
JNTU COLLEGES

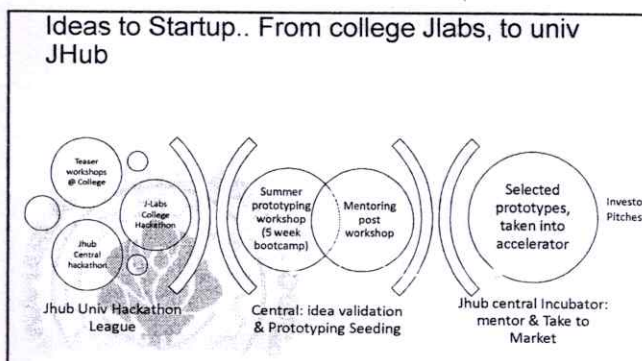

PRINCIPAL
Geethanjali College of Engg. Techn.
Cheerai (V), Keesara (M), R.R. Dist. (A.P.) - 501 301

Cyber Physical Systems

Theme: Cyber Physical Systems – Industry 4.0

A cyber-physical system (CPS) is a mechanism that is controlled or monitored by computer-based algorithms, tightly integrated with the Internet and its users.

Examples of CPS include

- Smart grid
- Autonomous automobile systems
- Medical monitoring
- Process control systems
- Robotics systems
- Automatic pilot avionics
- Industrial IoT

IoT –LoRa
EDGE computing
AI
ML
AR/VR
Drones

Central hackathon Steps

- Announcement: Feb 2
- Detailed Guidelines: Feb 3
- Idea submission Feb 10
- Registration form link: [tinyurl/jhubhack1](http://tinyurl.com/jhubhack1)
- Shortlisting Feb 12
- Inventory list Feb 12
- Deep Dive Boot Camp on Cyber physical systems - Industrial IoT Feb 16-17
- Hackathon Feb 23-24

EXCITE2k18

Ideation contests, Tech Bootcamps and Hackathons within college

Shortlisting based on participation at Bootcamps & Central Hackathon at J-hub

First SpoC Hub Camp on Feb 2 followed by Feb 16

First Central Hackathon on 23-24 Feb

POSTER FOLLOWS..

JNTU J-Hub – University Wide Innovation/Startup Program ANNOUNCEMENT

Excitement around innovation – Exposure (UX) to interesting products & startups, Trainer workshops & seminars
Create a culture of "building" tech prototypes, ideation, Experimentation, Prototyping, Create tech product based startups, Meet the Prototypes
Hub and Spoke model: Central Hub at Univ campus (JHub); College level spokes (ILabs)
Students & learn from college level, get help from central Jhub.
Jhub will connect with T-Hub, State Innovation Cell and other city enablers.

JHub- Univ level, central
ILabs- College level



Ideas to Startups.. From college ILabs, to univ JHub

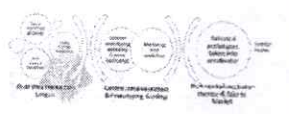

Calendar..

Month	Year	Event	Date
Jan	2018	Registration	10-12
Feb	2018	Shortlisting	12
Feb	2018	Deep Dive Boot Camp	16-17
Feb	2018	Hackathon	23-24

Interested? Sign up now.
1st/2nd year - for excel, 3rd/4th year for ICell

Thanks

PRINCIPAL
CENTRAL HUB
JNTU J-HUB
JNTU K.R. Rao

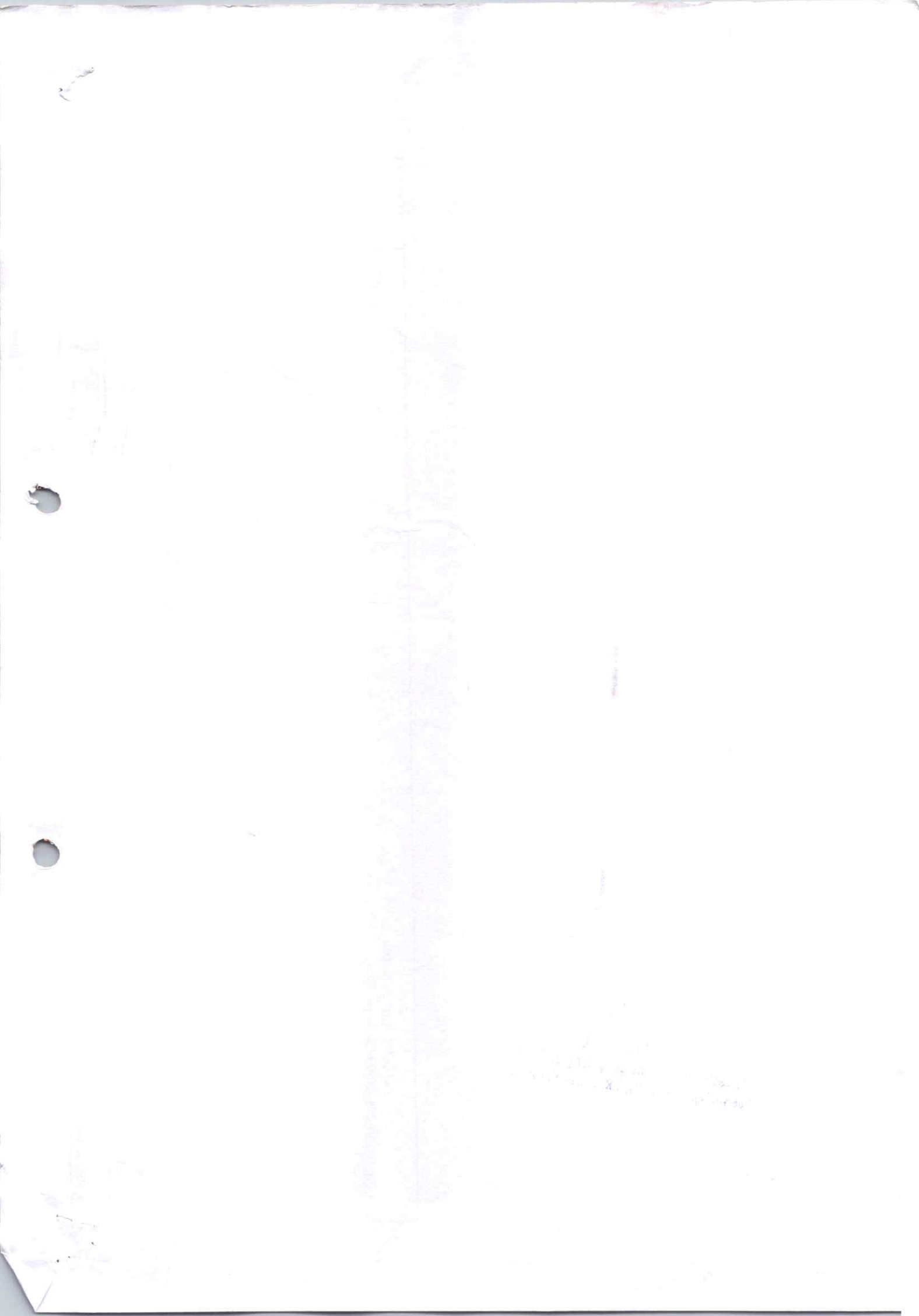

Yvn Phanikishore <yvnphanikishore@gmail.com>



JHUB- JNTUH Boot Camp

message

Wed, May 9, 2018 at 11:14 AM

Chandra Nagulapalli <chandra.nagulapalli@gmail.com>
To: prathyushac98@gmail.com, carol navya <carolnavya1999@gmail.com>, thilakarvind@gmail.com,
eswar.hemanth143@gmail.com, kaushik.adusumilli9@gmail.com, sairamrao96@gmail.com
Cc: Yvn Phanikishore <yvnphanikishore@gmail.com>

Dear All,
A Very good morning.

This is to inform all that the JNTUH - JHUB Bootcamp is scheduled from
28/05/2018 to 8/06/2018.

All the students are requested to get their own laptops during the bootcamp.

There will be a competition towards the end of the boot camp wherein you can win exciting prizes

Regards
N. Chandrakath.

PRINCIPAL
Geethanjali College of Engg. Tech.
Cheeryal (V), Keeravaram (H), R.R. Dist. (A.P.) - 501 301

GEETHANJALI COLLEGE OF ENGINEERING AND TECHNOLOGY

BOOT CAMP STUDENT LIST

S.No	Name	Roll No	Branch	Phone	Email
1	C. Prathyusha		CSE A	6300524858	prathyushac98@gmail.com
2	P. Carol Navya		CSE D	9618176142	carolnavya1999@gmail.com
3	P. Arvind Tilak		Mech	9177003048	thilakarvind@gmail.com
4	Majeti Eswar Hemanth		ECE	8885319264	eswar.hemanth143@gmail.com
5	A. Koushik		ECE	9704998784	kaushik.adusumilli9@gmail.com
6	C. Sai Ram Rao		ECE	7075653264	sairamrao96@gmail.com

PRINCIPAL

Geethanjali College of Engg. Techn.
Cheeryal (V), Keesara (M), R.R. Dist. (A.P.) - 501 301

Secure | <https://docs.google.com/forms/d/e/1FAIpQLSeRAAieZblacNIGoteYUEF-2E-cILqPmmD9EfeWLSmb6pazQ/viewform?c=0&w=1>

BOOTCAMP on Innovation and Entrepreneurship

2 week Bootcamp on innovation / entrepreneurship is being organized for B. Tech II year students. Each J-Lab shall nominate 2 teams of size 3 each. The Bootcamp is intensive programme covering ideation, product thinking and elements of venture establishment. The Bootcamp is scheduled during 2/3 week of May 2018

* Required

Name of the Team Member_1 *
C.Pratyusha

Contact Number *
6300524858

Email Id *
pratyushac98@gmail.com

Name of the Team Member_2 *

4:57 PM
4/13/2018

Secure | <https://docs.google.com/forms/d/e/1FAIpQLSeRAAieZblacNIGoteYUEF-2E-cILqPmmD9EfeWLSmb6pazQ/viewform?c=0&w=1>

Name of the Team Member_2 *
P.Carol Navya

Contact Number *
9618176142

Email Id *
carolnavya1999@gmail.com

Name of the Team Member_3 *
Your answer

Contact Number *
Your answer

4:58 PM
4/13/2018

K

PRINCIPAL
Geethanjali College of Engg. Techn.
Cheerjal (V), Keasara (M), R.R. Dist. (A.P.) - 501 301

Secure | <https://docs.google.com/forms/d/e/1FAIpQLSeR4Aie2blodN15bteYUEF-2E-cRlqFmDSEleWtLamb6pqcQ/viewform?c=0&w=1&fz=694202273968284900>

Name of the College *

Geethanjali

Have you participated in any J-Lab activity

Any recognition in J-Lab / Entrepreneurship event

Participated in Hackathons

Name of the SPOC who has validated the application *

N Chandrakanth

Mobile no of the SPOC *

9885723167

5:01 PM
4/19/2018

Secure | <https://docs.google.com/forms/d/e/1FAIpQLSenhPnoK4Joni8n8Y076eS19-uLS7X8znNri8ohuioRyu8g/viewform?c=0&w=1>

The name and photo associated with your Google account will be recorded when you upload files and submit this form. Not yynphankishore@gmail.com? [Switch account](#)

* Required

Name of the Team Member_1 *

Chitneni Sai Ram Rao

Contact Number *

7075653264

Email Id *

sairamrao96@gmail.com

Name of the Team Member_2 *

K S VEERENDERNATH

Contact Number *

5:01 PM
4/19/2018

PRINCIPAL
Geethanjali College of Engg. Tech.
Cheerthol (V), Keesara (M), R.R. Dist. (A.P.) - 501 301

Unsaved - EXCTE - 2018

Secure | <https://docs.google.com/forms/d/e/1FAIpQL5anhPnoK4krd8nBY096sS19-u157XRzmlR8ohulouRyu8g/viewform?c=0&w=1>

Email Id *

sairamrao96@gmail.com

Name of the Team Member_2 *

K S VEERENDERNATH

Contact Number *

8520054854

Email Id *

veerendernathkomala@gmail.com

Name of the Team Member_3 *

P Nikitha Reddy

3:02 PM
4/19/2018

PRINCIPAL
Geethanjali College of Engg. Tech.
Cheeruvu (V), Koneseru (M), R.R. Dist. (A.P.) - 501301

OFFICE OF THE PRINCIPAL

CIRCULAR

Reference: GEETHANJALI CUBE OPEN – 2018

The “Center for Innovation and Creativity” and “Mathematics Club” of Geethanjali College of Engineering and Technology in association with “Deccan Cubing Organization” will be organizing Cube competition “Geethanjali Cube Open – 2018” on **21st Jan., 2018** in the college premises.

Venue: Seminar Hall, Block 2 , Geethanjali College of Engineering and Technology

Date and Time: 21st January, 2018, From 9:00 AM till 6:00 PM

Prize distribution at 5:30 PM on the same day.

Registrations: www.worldcubeassociation.org On or before 17-1-2018

Events:

- 3*3 cube solution.
- 4*4 cube solution.
- 2*2 cube solution.
- 3*3 cube one hand solution.
- Pyramix solution
- Skweb solution.

Associates:

WCA: World Cube Association-Organizing.

GCET: Geethanjali College of Engineering and Technology-Organizing and Event Management

Cubelelo: Cube Distributer and Title Sponsor.

KKtechs: Prize Sponsors.

FACULTY CO-ORDINATORS: Dr.V.S.Triveni - Mathematics Club
Mr. N.Chandranth – Innovant Technocrat Club

STUDENT CO-ORDINATORS & CONTACT NUMBERS:

C.V.S.B Bharadwaja – MECH 3A(7032911698)

D.V.N Ramya Samhitha – CSE 3D(9704410531)

M.Harshini – CSE 3D(9618256778)

To: Deans / HODs

PRINCIPAL
Geethanjali College of Engg. Tech.
Cheeryal (V), Keesara (M), R.R. Dist. (A.P.) - 501 301

PRINCIPAL

GEETHANJALI

CUBE OPEN - 2018

21st - January - 2018.

Events:

SCHEDULE

3x3 cube solution

4x4 cube solution

2x2 cube solution

3x3 OH (one hand)

Pyramix solution

Skweb. solution.

Morning Session: (09:00 AM - 1:00 PM)

09:00 AM - 10:00 AM : final Round

Skweb solution - cut off 20 seconds.

10:00 AM - 11:00 AM : final Round.

4x4 cube solution - cut off 1:40 minutes.

11:00 AM - 01:00 PM - Round 1

3x3 cube solution - NO cut off.

Lunch:

01:00 PM - 01:30 PM

Afternoon session: (01:30 PM - 4:15 PM)

01:30 PM - 2:15 PM : OH (one hand) Round 1

3x3 cube solution - cut off 1 min.

2:15 PM - 3:00 PM : Round 1

2x2 cube solution - cut off 20 seconds.

PRINCIPAL

Geethanjali College of Engg. Tech.

Cheruvu (V), Kossuru (M), R.R. Dist. (A.P.) - 501 301

21st December, 2017

To

The Principal

Geethanjali College of Engineering and Technology

Cheeryal

Keesara

Respected Sir

Subject: Request for Organizing cubing competition
in our college reqd..

We request you to permit us to organize "Rubick's
Cube" competition in our college on 21st January, 2018.

We request you to grant permission to use Seminar
Hall. (Block-II)

We are expecting about 150 participants.

Please find the enclosed Request letter from "DECCAN
CUBING" organisation.

Thanking You.

Student Co-ordinators:

L.V.S.B. Bhasadwaj - 15R11A0314 (Mech-3A)

D.V.N. Ramya Sambhitha - 15R11A05K3 (CSE-3D)

M. Haashini - 15R11A05M2 (CSE-3D)

PRINCIPAL
Geethanjali College of Engg. Tech.
Cheeryal (V), Keesara (M), R.R. Dist. (A.P.) - 501 307

OK

Sir

21/12



DECCAN CUBING

Title: Permission for conducting a competition

Date: 21/12/2017

To,

The Principal,

Geethanjali college of engineering and technology.

Respected Sir,

We would like to Conduct an International Rubik's Cube Competition in college in Coordination with the students. The Competition will be managed by Deccan Cubing.

Support we required from college.

- 1) Two Student Coordinators
- 2) Auditorium or big hall which will be used as competition area.
- 3) 15-20 Volunteers from college.

All the Required Equipment for the competition will be provided by Deccan Cubing and other delegates From India

- 1) Stack mat timers, Stopwatches, Cube covers.
- 2) Additional Stationary
- 3) Banner and Certificates For participants, volunteers and winners.
- 4) Memento or Medals for all the Winners.

All the competition requirements will be discussed with the Student Coordinators.

Best regards,

Pavan Kumar Akula

Founder – Deccan Cubing

PRINCIPAL
Geethanjali College of Engg. Techn.
Cheerla (V), Keesara (M), R.R. Dist. (A.P.) - 501 301

+91 720 727 7021
+91 703 296 9696

Pavanakula21@gmail.com
www.deccancubing.org

16-11-142/A, Moosarambagh,
Malakpet, Hyderabad, Telangana
500036





Geethanjali

Phone : 9533791618
Fax : +91-40-24220320
Website: www.geethanjalinstitutions.com
info@gcet.edu.in

Geethanjali College of Engineering and Technology

AUTONOMOUS

(Accredited by NBA, Approved by AICTE, New Delhi)

Sy.No. 33 & 34, Cheeryal (V), Keesara (M), Medchal District. - 501 301.

GEETHANJALI CUBE OPEN 2018

Letter of Appreciation

We appreciate the exemplary efforts of **Ms. R.Shivani (CSE-3D)** as volunteer of the event "**GEETHANJALI CUBE OPEN 2018**" organized in association with "**World cube Association & Deccan Cubing**" on 21st January 2018.

Faculty Coordinators

Principal
PRINCIPAL
Geethanjali College of Engg. and Tech.
Cheeryal (V), Keesara (M), Medchal Dist.(T.S.)-501 301.

PRINCIPAL
Geethanjali College of Engg. Techn.
Cheeryal (V), Keesara (M), R.R. Dist. (A.P.) - 501 301.

Sponsored by **TEJA EDUCATIONAL SOCIETY, HYDERABAD**

Office : Sy. No. 33 & 34, Cheeryal (V), Keesara (M), Medchal Dist. - 501 301.

Phones : 9533791618, 7306295152



Geethanjali

Phone : 9533791618
Fax : +91-40-24220320
Website: www.geethanjaliinstitutions.com
info@gcet.edu.in

Geethanjali College of Engineering and Technology

AUTONOMOUS

(Accredited by NBA, Approved by AICTE, New Delhi)

Sy.No. 33 & 34, Cheeryal (V), Keesara (M), Medchal District. - 501 301.

GEETHANJALI CUBE OPEN 2018

Letter of Appreciation

We appreciate the exemplary efforts of **Ms. P.Swathi (CSE-3D)** as volunteer of the event "**GEETHANJALI CUBE OPEN 2018**" organized in association with "**World cube Association & Deccan Cubing**" on 21st January 2018.

Faculty Coordinators

Principal
PRINCIPAL
Geethanjali College of Engg. and Tech.
Cheeryal (V), Keesara (M), Medchal Dist.(T.S.)-501 301.

PRINCIPAL
Geethanjali College of Engg. Tech.
Cheeryal (V), Keesara (M), R.R. Dist. (A.P.) - 501 301.

Sponsored by **TEJA EDUCATIONAL SOCIETY, HYDERABAD**

Office : Sy. No. 33 & 34, Cheeryal (V), Keesara (M), Medchal Dist. - 501 301.

Phones : 9533791618, 7306295152

ICANN Fee: Rs12.00
Discount: Rs599.00
Subtotal: Rs12.00
Taxes: Rs1.80
Total: Rs13.80

Website Builder Business

Item Number: 1058162
Quantity: 1
Term: 1

List Price: Rs0.00
Purchase Price: Rs0.00
ICANN Fee: Rs0.00
Discount: Rs0.00
Subtotal: Rs0.00
Taxes: Rs0.00
Total: Rs0.00

Ultimate Linux Hosting with cPanel
geethanjaliapps.com

Item Number: 32082
Quantity: 1
Term: 1

List Price: Rs11,988.00
Purchase Price: Rs8,148.00
ICANN Fee: Rs0.00
Discount: Rs0.00
Subtotal: Rs8,148.00
Taxes: Rs1,222.20
Total: Rs9,370.20

Standard SSL
geethanjaliapps.com

Item Number: 3604
Quantity: 1
Term: 1

List Price: Rs4,399.00
Purchase Price: Rs0.00

PRINCIPAL
Geethanjali College of Engg. Techn.
Choeryal (V), Keesara (M), R.R. Dist. (A.P.) - 501362



Geethanjali College of Engineering and Technology
(UGC Autonomous)

CHEERYAL (V), KEESARA (M) - 501301, Telangana

Date: 16/02/2018

To,

The Principal,
Geethanjali College of Engineering and Technology,
Cheeryal (V), Keesara (M), Medchal Dist.
Telanagana State – 501301

Respected Sir,

Sub: Renewal of Domain for Geethanjali Apps

Our College has been running Geethanjali College App on the servers of (GoDADDY) which is about to expire in the month of March, 2018.

We are planning to renew this for 2 years rather than one year. Approximate cost of the renewal would be Rs. 15,000.00 (Rs. Fifteen Thousand Only).

We request you to kindly approve this renewal, to enable smooth functioning of the app.

Regards

Prof. N. Chandrakanth

Y.V.N. Phanikishore

PRINCIPAL
Geethanjali College of Engg. Tech.
Cheeryal (V), Keesara (M), R.R. Dist. (A.P.) - 501301



Geethanjali College of Engineering and Technology
(UGC Autonomous)

CHEERYAL (V), KEESARA (M) - 501301, Telangana

Date: 16/02/2018

To,

The Principal,
Geethanjali College of Engineering and Technology,
Cheeryal (V), Keesara (M), Medchal Dist.
Telanagana State – 501301

Respected Sir,

Sub: Renewal of Domain for Geethanjali Apps

Our College has been running Geethanjali College App on the servers of (GoDADDY) which is about to expire in the month of March, 2018.

We are planning to renew this for 2 years rather than one year. Approximate cost of the renewal would be Rs. 15,000.00 (Rs. Fifteen Thousand Only).

We request you to kindly approve this renewal, to enable smooth functioning of the app.

Regards

Prof. N. Chandrakanth

Y.V.N. Phanikishore

PRINCIPAL
Geethanjali College of Engg. Tech-
Cheeryal (V), Keesara (M), R.R. Dist. (A.P.) - 501301

16/02/18

Purchase by Credit Card

PRINCIPAL
Geethanjali College of Engg. Tech.
Narasaraopeta (N), Keesara (M), R.Z. Dist., (A.P.) - 501 301



Card Number
4375 5105 1601 6000

MM / YY
06 / 18

CVV (3 digits)



PAY NOW

Order Summary

Receipt ID: HIN16733473

Business Web Hosting

Rs. 11,976.00

Total

~~Rs. 16,776.00~~
Rs. 11,976.00



SSL SECURE PAYMENT

Your encryption is protected by
256-bit SSL encryption

Purchase by Credit Card



PRINCIPAL
Geethanjali College of Engg. Tech.
Cheerpal (Y), Keasara (M), R.R. Dist. (A.P.) - 501 301

Card Number

Expiration Date

CWV

PAY NOW

Order Summary

Receipt ID: HIN16753473

Business Web Hosting

Rs. 11,976.00

Total

~~Rs. 16,776.00~~
Rs. 11,976.00



SSL SECURE PAYMENT

Your encryption is protected by
256-bit SSL encryption

✓ Payment completed.

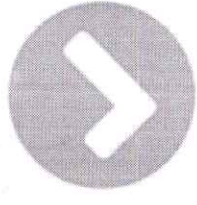

Thank you!

PRINCIPAL
Geethanjali College of Engg. Tech.
Cheerayal (V), Keerasuru (M), R.R. Dist. (A.P.) - 501 301

We are excited to have you as the new premium member and can hardly wait to see what you'll build here. You are ready to start now!

SET UP YOUR ORDER



Geethanjali

Phone : 9533791618

Fax : +91-40-24220320

Website: www.geethanjaliinstitutions.com
info@gcet.edu.in

Geethanjali College of Engineering and Technology

AUTONOMOUS

(Accredited by NBA, Approved by AICTE, New Delhi)

Sy.No. 33 & 34, Cheeryal (V), Keesara (M), Medchal District. - 501 301.

GEETHANJALI CUBE OPEN 2018

Letter of Appreciation

We appreciate the exemplary efforts of **Ms. Mahitha (CSE-2D)** as volunteer of the event "GEETHANJALI CUBE OPEN 2018" organized in association with "World cube Association & Deccan Cubing" on 21st January 2018.

Faculty Coordinators

Principal
PRINCIPAL

Geethanjali College of Engg. and Tech.
Cheeryal (V), Keesara (M), Medchal Dist.(T.S.)-501 301.

PRINCIPAL
Geethanjali College of Engg. Tech.
Cheeryal (V), Keesara (M), R.R. Dist. (A.P.) - 501 301

Sponsored by **TEJA EDUCATIONAL SOCIETY, HYDERABAD**

Office : Sy. No. 33 & 34, Cheeryal (V), Keesara (M), Medchal Dist. - 501 301.

Phones : 9533791618, 7306295152



Geethanjali

Phone : 9533791618
Fax : +91-40-24220320
Website: www.geethanjaliinstitutions.com
info@gcet.edu.in

Geethanjali College of Engineering and Technology

AUTONOMOUS

(Accredited by NBA, Approved by AICTE, New Delhi)

Sy.No. 33 & 34, Cheeryal (V), Keesara (M), Medchal District. - 501 301.

GEETHANJALI CUBE OPEN 2018

Letter of Appreciation

We appreciate the exemplary efforts of **Ms. P.Chucharita (Mech-2B)** as volunteer of the event "GEETHANJALI CUBE OPEN 2018" organized in association with "World cube Association & Deccan Cubing" on 21st January 2018.

Faculty Coordinators

Principal
PRINCIPAL
Geethanjali College of Engg. and Tech.
Cheeryal (V), Keesara (M), Medchal Dist.(T.S.)-501 301.

PRINCIPAL
Geethanjali College of Engg. Tech.
Cheeryal (V), Keesara (M), R.R. Dist. (A.P.) - 501 301

Sponsored by **TEJA EDUCATIONAL SOCIETY, HYDERABAD**

Office : Sy. No. 33 & 34, Cheeryal (V), Keesara (M), Medchal Dist. - 501 301.

Phones : 9533791618, 7306295152

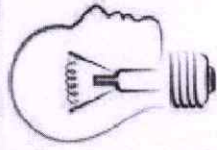

INNOVANT
TECHNOCRAT CLUB

Creativity and Innovation

N. Chandrakanth
Professor
CSE Dept

Geethanjali College of Engineering and Technology

PRINCIPAL
Geethanjali College of Engg. Techn.
Cheeryal (V), Keesara (M), R.R. Dist. (A.P.) - 501 301



Creativity and Innovation

N. Chandrakanth
Professor
CSE Dept
Geethanjali College of Engineering and Technology



Idea

- **Idea** is a thought or collection of thoughts that generate in the mind.
- An idea is usually generated with intent, but can also be created unintentionally.
- Ideas often form during brainstorming sessions or through discussions.



Creativity

- **Creativity** is about *unleashing the potential* of the mind to conceive new ideas.
- Creative ideas can also be thought experiments within one person's mind.
- Creativity is subjective, making it hard to measure.



Innovation

- **Innovation** is an act of application of new ideas to which creates some value for the business organization, government, and/or society at large.
- Better and smarter way of doing anything is innovation.
- Innovation is about introducing change into relatively stable systems.
- Innovation is completely measurable.



Creativity Vs Innovation

BASIS FOR COMPARISON	CREATIVITY	INNOVATION
Meaning	Creativity is a act of creating new ideas, imaginations and possibilities.	Innovation is the introduction of something new and effective into the market.
Process	Imaginative	Productive
Quantifiable	No	Yes
Related to	Thinking something new	Introducing something new
Money Consumption	No	Yes
Risk	No	Yes

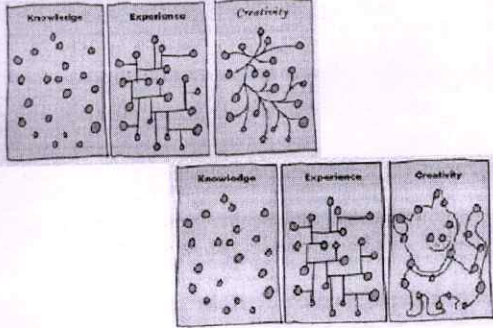

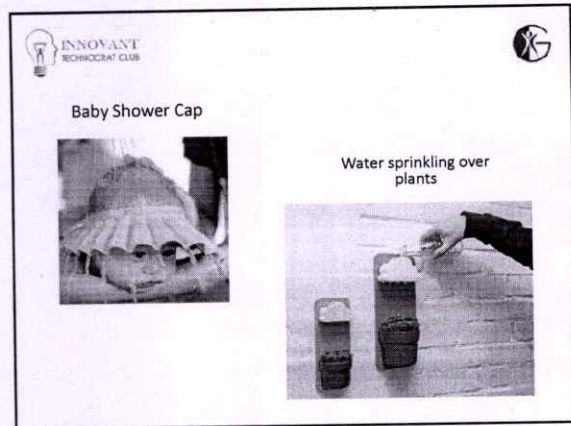
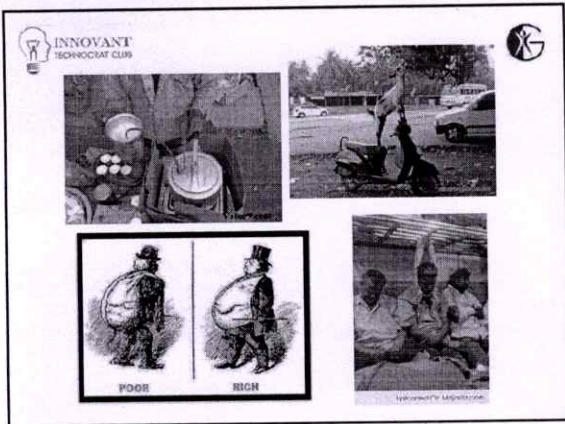

PRINCIPAL
 Geethanjali College of Engg. Tech.
 Cheruvu (V), Keestara (M), R.R. Dist. (A.P.) - 501 301

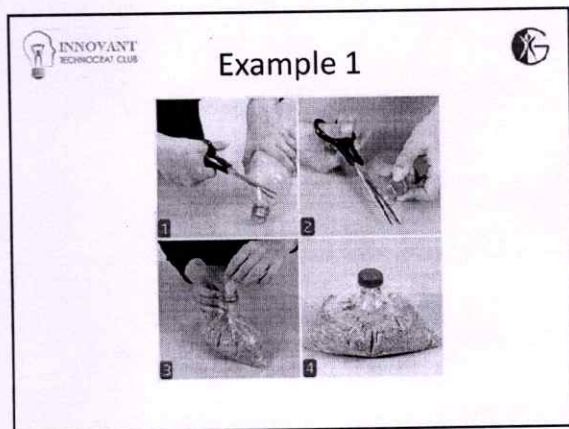

5 Stages of Creative Process

- **preparation**
 - (preparatory work on a problem that focuses the individual's mind on the problem and explores the problem's dimensions)
- **incubation**
 - (where the problem is internalized into the unconscious mind and nothing appears externally to be happening)
- **intimation**
 - (the creative person gets a "feeling" that a solution is on its way)
- **illumination or insight**
 - (where the creative idea bursts forth from its preconscious processing into conscious awareness)
- **verification**
 - (where the idea is consciously verified, elaborated, and then applied).



Light – Solar powered

- Liter of Light is a global open source movement with the aim to provide an ecologically and economically sustainable source of light. The aim is to provide light to underprivileged households that do not have access to electricity or are unable to afford it. The invention is relatively simple. It involves filling up a 1.5L PET bottle with purified water and bleach and installing it onto the roof of a house. The water inside the bottle refracts the sunlight during the daytime and creates the same intensity as a 55 watt light bulb. With the correct installation and materials a solar bottle can last up to 5 years. As the light relies on the sun it cannot be used at night and is only meant to provide light to buildings and homes during daylight hours.

Mitti Cool

Mansukh Prajapati, a potter, came up with this terrific idea of a building a clay refrigerator for people who cannot afford refrigerators. Called as the Mitti Cool fridge, the contraption measuring 18.5 inch in height and 11 inch in width has two water tanks – one each at the top and the bottom. The working of the fridge is similar to that of clay pots used in rural areas, ones that keep water cool in the summers. It requires neither electricity nor any artificial form of energy so reducing recurring costs to zero. MittiCool's total costs in around Rs. 2000/-, which is almost 80% lesser than conventional refrigerator.

PRINCIPAL
Geethanjali College of Engg. Techn.
Cheerayal (V), Keesara (M), R.R. Dist. (A.P.) - 501 302.

INNOVANT TECHNOCRAT CLUB

Challenge -1

INNOVANT TECHNOCRAT CLUB

Hair Clip - Innovation

INNOVANT TECHNOCRAT CLUB

Hair Clip - Innovation

INNOVANT TECHNOCRAT CLUB

Convenient reading Glasses

INNOVANT TECHNOCRAT CLUB

Stair climbing Wheelchair

INNOVANT TECHNOCRAT CLUB

Life Straw

- "LifeStraw is a water filter designed to be used by one person to filter water so that they may safely drink it. It filters a maximum of 1000 litres of water, enough for one person for one year. It removes almost all of waterborne bacteria and parasites."

PRINCIPAL
 Geethanjali College of Engg. Tech.
 Chaorpal (M), Keesara (M), R.R. Dist. (A.P.) - 501 301

INNOVANT TECHNOCHAT CLUB

Temperature Indicator Shower

100°F
106°F
112°F
118°F

Warm and hot charger

Solar Chargers

INNOVANT TECHNOCHAT CLUB

Self Filling Water Bottle

INNOVANT TECHNOCHAT CLUB

Zing Wickets

- The Zing wickets have LED lights which can determine whether the wicket is broken (when the balls are completely dislodged from the stumps).
- The balls have an inbuilt sensor (sensitive to radio waves) that can determine within 1/1000 of a second when the wicket is broken. If the wicket is broken, the balls will flash bright red LED lights. They will then send radio signals to the stumps which will also start flashing the red light.
- Talking of the cost, these LED lights are powered by low voltage batteries, which are integrated in each of the balls as well as the stumps, which is 100 times better than a Snickometer, which uses a hot spot technology, using 2 cameras that requires a \$600 per day of a match!!

INNOVANT TECHNOCHAT CLUB

Pedal operated Washing Machine

Youngest national innovation award winner

Exercise as you wash!!

Pedal operated washing machine

Shraddha Jeevanti

INNOVANT TECHNOCHAT CLUB

Agriculture spray machine

UAV Product Delivery Vehicle

Man less warfare

UAV Passenger Delivery Vehicle

INNOVANT TECHNOCHAT CLUB

Observation and Thought

THOUGHT spark

PRINCIPAL
Goethanjali College of Engg. Tech.
Cheeraj (M), Koesara (M), R.R. Dist. (A.P.) - 501304

INNOVANT TECHNOCRAT CLUB

Innovation Center

- Goal is to provide a nurturing environment to technology based ideas to prosper and become viable contributors to our community and economy.
- An attempt to bring academia and industry closer to each other by providing students and faculty a platform to research and development of technology based business ideas.



Challenge -2

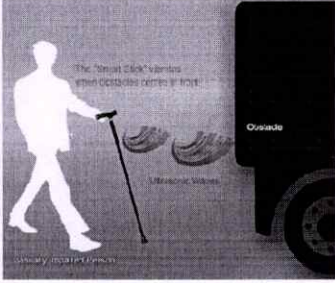

INNOVANT TECHNOCRAT CLUB

Your Ideas

- Reduction in usage of Fossil Fuels
 - Non-conventional fuels (solar, wind, water etc.,).
 - Solar powered Windows
 - Use day-to-day mechanical/physical work to generate energy/power.
- Vehicle tracker
 - Vehicle tracker at malls and crowded places
 - Vehicle tracker at traffic junctions
 - Addition battery to a GPS for tracking device.
- Security system in Trains (Railways compartment security)

INNOVANT TECHNOCRAT CLUB

Your Ideas

- Reduce air pollution
- Waste/Garbage management
- Accident response system
- Flexible Laser Finger pointers for presentations.
- Voice controlled keyboard for computers
- Voice based activity app for phones to avoid distraction during travel

INNOVANT TECHNOCRAT CLUB

Your Ideas

- Movable roads
- Earthquake resistant buildings
- Clean up space debris
- Efficient mobile network (reduce call drops etc.,)
- Implement Elon musk's idea on designing and building cost effective vehicles.

INNOVANT TECHNOCRAT CLUB

New ideas ...?

- Wearable technology
- Mind reading shopping Cart
- Your body your login
- Improved sanitation

PRINCIPAL
 Goethanjali College of Engg. Tech.
 Cheerla (V), Keesara (M), R.R. Dist. (A.P.) - 501 304

BYCYCLE MOBILE CHARGER

Team: D.V.Varma (15R11A0315)

Venkat (15R11A0244)

Shreyas (15R11A05B8)

Hameed (14R11A04L5)

PROBLEM STATEMENT

It is the most common problem faced by people in their day to day life. People travelling long distances would commonly face this issue.

"As a rule, the charging voltage with the engine at fast idle should usually be about 1-1/2 to 2 volts higher than battery voltage..An alternator failure will cause the battery to run down and go dead . Symptoms of charging problem include a low battery, dim headlights, hard starting or a charging system warning light."

PRINCIPAL
Geethanjali College of Engg. Tech.
Cheerpal (V), Keesara (M), R.R. Dist. (A.P.) - 501 301

CIRCUIT DIAGRAM

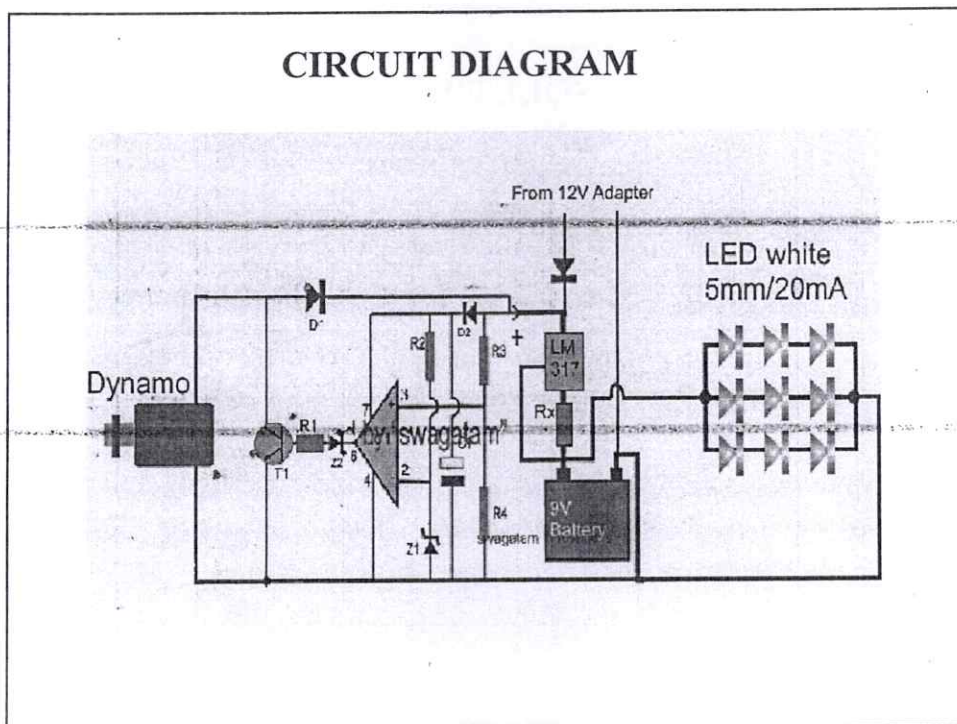

COMPLETION REPORT

Current status :

we have fixed almost all the problems we faced ,around 70% for the project work is done and we are left over with assembling the entire parts of our project.

PRINCIPAL
Geethanjali College of Engg. Tech.,
Geethanjali Nagar (H), R.R. Dist. (A.P.) - 501 304

Principal (V), Geethanjali (H), R.R. Dist. (A.P.) - 501 304

PROBLEM STATEMENT:

The general ways of producing electricity is from renewable sources of energy like the thermal energy which may soon disappear. Production of thermal energy also causes lot of atmospheric pollution and damages the environment and results in the destruction of ozone layer. So we need some alternative sources to produce the energy. This could be done by the sounds around us.

ABSTRACT:

- We come across various sounds in our daily life. These sounds are generally in the audible range and hence have a good intensity of vibration in the atmosphere. These sounds can be used to produce the electricity. The sounds can be trapped and forced onto the piezoelectric crystals which produce electricity when hit by mechanical forces.

ABSTRACT:

SOLUTION:

- The best way to produce electricity at cheaper rates is by using the waste sounds which are disturbances in the ear. These sounds can be trapped with the help of the microphones and then forced onto the piezo electric crystals which produces the energy. This energy is then multiplied by the capacitors and resistors which can constantly multiply the varying input.

PRINCIPAL
Geethanjali College of Engg. Tech.
Cheerayal (V), Keesara (M), R.R. Dist. (A.P.) - 501 301

SOUND

Bharadwaj 15R11A0314

Vishal 15R11A0343

Tanmayi 15R11A05A5

Sujana 15R11A0493

Manikanta 15R11A04F2

Varsha

PROBLEM STATEMENT:

- The general ways of producing electricity is from renewable sources of energy like the thermal energy which may soon disappear. Production of thermal energy also causes lot of atmospheric pollution and damages the environment and results in the destruction of ozone layer. So we need some alternative sources to produce the energy. This could be done by the sounds around us.

PRINCIPAL
Geethanjali College of Engg. Techn.
Cheeraj (V), Keesara (N), R.R. Dist. (A.P.) - 501 301

15/4/2017

Smart Switch

Team Members :

S.Piyush Balaji

Harshith

K.V.Nikhil

Shiva Kumar

Smart Switch Problem Statement

- People these days turn on the lights and fans in the room and forget to switch off due to which there is a lot of wastage of electricity.

PRINCIPAL
Geethanjali College of Engg. Tech.
Chengalpet, Kalluru (M), R.R. Dist. (A.P.) - 501 301

Design for solution

- HW required : PIR Sensor with arduino and relay module
- SW required : Arduino IDE

Completion Report

- Hardware connection is done but their has to be a small change in coding, other than that all is done.

PRINCIPAL
Geethanjali College of Engg. Techn.
Cheeraj (V), Kosara (M), R.R. Dist. (A.P.) - 501 301.

Attendance

1) Thejesh.B - 15R11A0312 -

27/02/2017

2) D.V.N Ramya - 15R11A05K3

3) G. Bharath - " 5K5 -

4) P. Gowshma - 5A0 -

5) K.V.B Sai Sreekar - 4L7 -

6) J. Sai Venkata Tarun - 15R11A0479 -

7) Abhijeet Kumar - 14R11A0410 -

8) A.V. Ram Kanjar - 15R11A0512 -

9) S. Nagalakshmi - 15R11A05B0 -

10. A. Pranav - 14R11A04M6 -

11. T. Srikar - 15R11A0352 -

12. A. Bruhadroop - " 562 -

13. K.J.C. Pavan - " 482 -

14. Bharadeoj - 15R11A0314 -

15. Varsha - 15R11A0221 -

16. Sujana - 15R11A0493 -

17. Tanmayi - 15R11A05A5 -

18. D.V. Varma - 15R11A0315 -

19. Venkat - 15R11A0344 -

20. Mohd. Hameed - 14R11A04L5 -

21. T. Raju - 15R11A0353 -

22. P.V.S. Profesh - 15R11A0346 -

23. Nischala B N - 15R11A0243 -

24. P.V. Babu -

24. G. Anil Kumar - 15R11A05K8 -

PRINCIPAL
Geethanjali College of Engg. Tech.
Cheerla (M), Keerana (M), R.R. Dist. (A.P.) - 501 301

1000

1000

1000

1000

1000

1000

1000

1000

1000

1000

1000

1000

① Srikar (Mech) Parking dist
Pranav (ECE)
~~Pavan (ECE)~~

PI or Arduino



② Viswadev Nath (ECE) - Electricity generation pad
(Piezo-material)
Santosh (Mech)
Sadiq (Mech)
Madhavi (ECE)

③ Bharadwaj (Mech) - Sound to electricity conversion
(Change of wavy papers)
Sujana (ECE)
Manikantha (ECE)
Tanmayi (CSE)

④ Piyush (EEE) - Smart switch
Shivakumar (CSE)

⑤ Abhijeet (ECE) - Sensor guide for visually disabled
Tarun (ECE)

Nagalaxmi } (CSE)

~~Greeshma~~

Vaishnavi (ESE)

abhijeetkumar179@gmail.com

⑥ Tej Thejesh (Mech) - Automated switch for vehicle
(High Beam to low beam)
Ranjeet (CSE)
Greeshma (CSE)
Pavan (ECE)

Iterative Approach

⑦ ~~Ana~~ Hameed (ECE)

Future Outlook

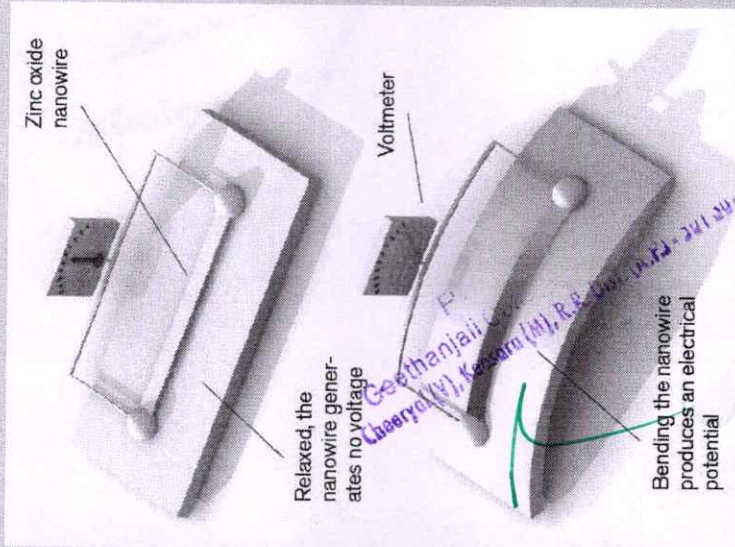

[7]

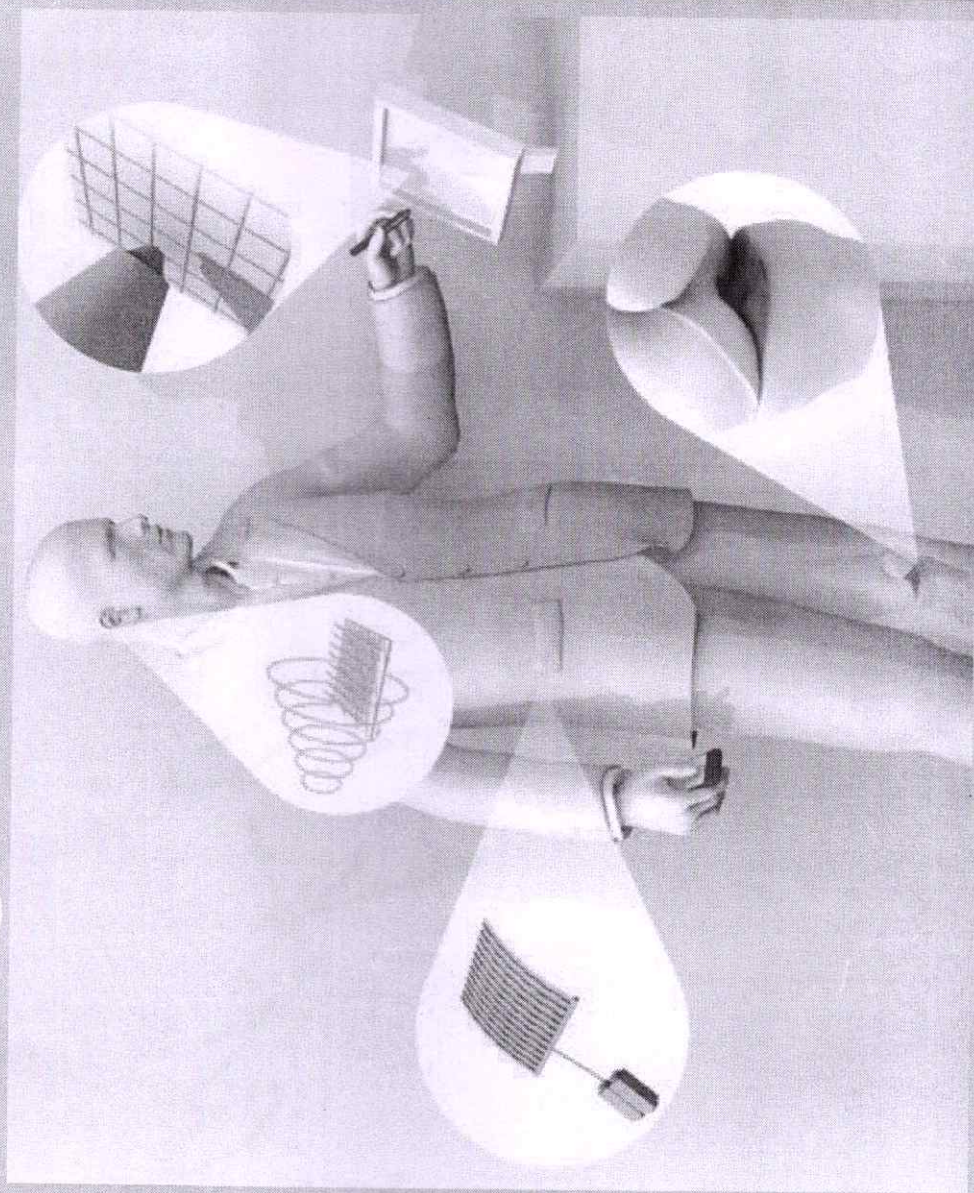

Design for solution

- HW required : PIR Sensor with arduino and relay module
- SW required : Arduino IDE

Completion Report

- Hardware connection is done but their has to be a small change in coding, other than that all is done.

PRINCIPAL
Geethanjali College of Engg. Techn.
Cheeraj (V), Keerasa (M), R.R. Dist. (A.P.) - 501 301

Parking Slots.

27/2/17

1. P. Manav Raju. A. ~~15R11A0486~~ 14R11A04M6 ECE-3D 9652139543
2. T. Srikanth Sharma 15R11A0352 - ME-2A 8985800046
3. A. Brahadroop 15R11A0562 - CSE-2B 9292955581
4. K. J. C. Pavan Kumar 15R11A0482 - ECE-2B .9000989876
5. Kireeti Bhyrovadshetty 14R11A0476 - ECE-3D 9652460964

Requirements :

1. LEDs:
2. Ultrasonic Sensors : Upto 50 ~~metres~~ metres
3. Counters (serial)
4. ~~Arduino~~ Arduino :
5. Cardboards / cartons.
- 6.

PRINCIPAL
Geethanjali College of Engg. Tech.
Cheerla (V), Keesara (M), R.R. Dist. (A.P.) - 501 301

27/2/17

WALKING PAD - CURRENT GENERATION

(1) Electronics

(i) D S JAYA MADHAVI ECE-2R 15R11A0472-7702158768

(ii) K S VEERENDRANATH ECE-2B 15R11A0483-8520754851

(2) Mechanical

(i) SANTOSH MECH-2A 15R11A0341-8125972714

(ii) SADIQ MECH-2A 15R11A0350-9184020760

Principal
Geethanjali College of Engg. Tech.
Geerpal (V), Keeravani (M), R.R. Dist. (A.P.) - 501 301

- ① P. V. S. Rakesh - 15R11A0346 - Mec 2A - Jatechchandra498@gmail.com
- 9160942975.
- ② Anil - 15R11A05K8 - CSE 2D - 9848591687 - anilginkala@gmail.com
- ③ Nischala - 15R11A0243 - EEE - 9492326941 - richu34@gmail.com
- ④ Raju - 15R11A0353 - Mec 2A - 9652050438 - johnsayu991@gmail.com
- ⑤ Sushanth - 15R11A0349 Mec 2A - 7288855067 - shanshankiredeemtion6@gmail.com

POWER GENERATION THROUGH Automobiles

PRINCIPAL
Geethanjali College of Engg. Tech.
Cheerupudi (V), Keesara (M), R.R. Dist. (A.P.) - 501 301

ABSTRACT:

- We come across various sounds in our daily life. These sounds are generally in the audible range and hence have a good intensity of vibration in the atmosphere. These sounds can be used to produce the electricity. The sounds can be trapped and forced onto the piezoelectric crystals which produce electricity when hit by mechanical forces.

ABSTRACT.

SOLUTION:

- The best way to produce electricity at cheaper rates is by using the waste sounds which are disturbances in the ear. These sounds can be trapped with the help of the microphones and then forced onto the piezo electric crystals which produces the energy. This energy is then multiplied by the capacitors and resistors which can constantly multiply the varying input.

PRINCIPAL
Geethanjali College of Engg. Tech.
Cheerthi (V), Keeravara (M), R.R. Dist. (A.P.) - 501 301

DESIGN FOR SOLUTION:

- The major components required are:
 1. 10 micro farad capacitors 3
 2. 100 ohm resistors 3
 3. 10 ohm resistor
 4. Piezo electric crystal
 5. Ucc 28600 ic
 6. Micro phone.

COMPLETION REPORT:

- Completed the purchase of all the equipment.
- Will be assembling the circuit in short time and then proceed for the testing stage.

PRINCIPAL
Geethanjali College of Engg. Tech.
Channarayana (V), Keesara (M), R.R. Dist. (A.P.) - 501 001

1. D.V.VARMA - ISRIIA0315 - ME-A - 2-2 (9010227002)
2. MOHD. HAMEED - ISRIIA0415 - ECE-D - 3-2 (7801061380)
3. VENKAT - ISRIIA0244 - EEE - 2-2 (8374960636)
4. VSHREYAS - ISRIIA05B8 - CSE-B - 2-2 (7036340365)

DYNAMO - CHARGER

- charging / without wires /
- Light Dimness
- sensor: — lights. — GPRS.

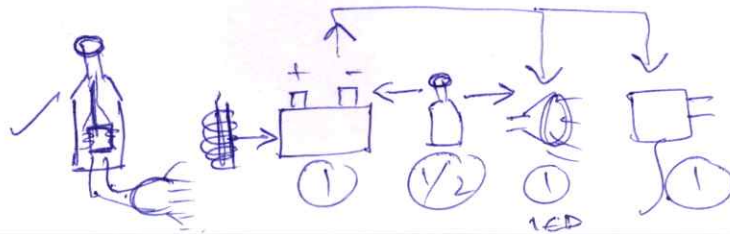

PRINCIPAL
 Geethanjali College of Engg. Tech.
 Choerapl (V), Keesara (M), R.R. Dist. (A.P.) - 501 301

Topic: Stript that absorbs harmful gases

Name - S. Kishore

Class - CSE

Section - 2D

Roll no - 15R11A05P0

Email Id - Santhapuri.kishorekk@gmail.com

phoneno - 8297031979

Name - G. Ajay kumar

class - CSE - 2B

section - 2B

Roll No - 15R11A0578

Email Id - ajaychand429@gmail.com

Phone no - 8520906516.

Name : N. Srikanth

Class : ECE - 2B

Section : 2B

Roll no : 15R11A0498

Email ID : srikanthnagam404@gmail.com

phoneno : 8333048973

Name : S. V. Ayyappa Naik

class : CSE - 2D

Section : 2D

Roll no : 15R11A05P3

Email ID : S.v.AyyappaNaik@gmail.com

Phoneno : 9652155157

PRINCIPAL
Geethanjali College of Engg. Techn.
Cheerpal (V), Kasarla (M), R.R. Dist. (A.P.) - 501 202

Biomedical Engineering Department

Contact: Michael Jorgensen michael.jorgensen@wichita.edu



Specialties & Expertise

Biomaterials:

Expertise: Design of biomaterials, surface modification of bio-metallic alloys, biodegradable metallic implants, nanotechnology, drug delivery, tissue engineering, and design and optimization of bio-devices

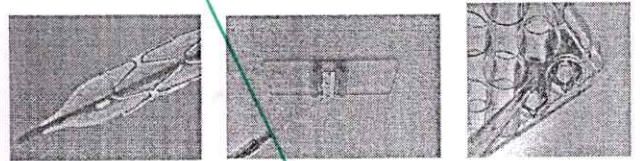

Tissue Engineering

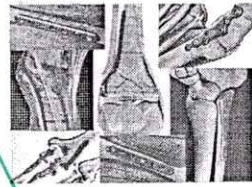

Stents

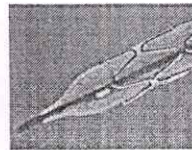

Biomedical Sensors, Imaging, and Computational Modeling:

Expertise: Quantitative approaches to improve medical diagnostics and treatment monitoring through application of mathematics, computational medicine, bioinstrumentation, and biomedical sensor design.

Ultrasound Imaging

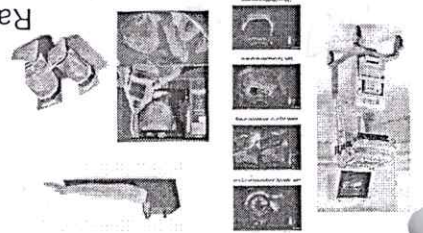

Raman micro-spectral

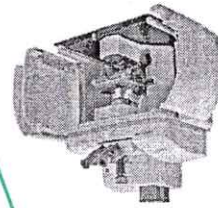

imaging

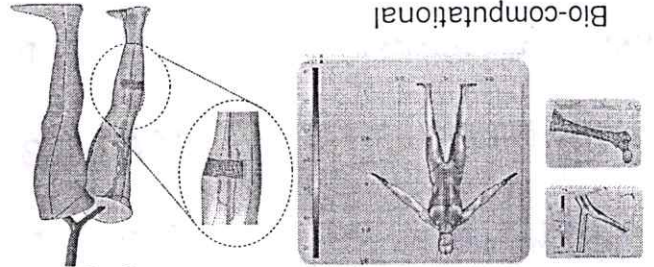

Bio-computational Modeling

Biomedical Sensors

Biomechanics:

Expertise: Musculoskeletal biomechanics, modeling and simulation of human movement, data acquisition and analysis, skeletal muscle force estimation, rehabilitation engineering and technology.

Modeling Human Movement

Motion Capture

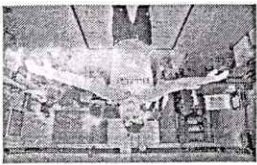

Movement Analysis

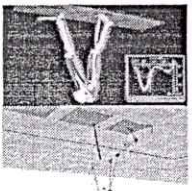

Signal Processing

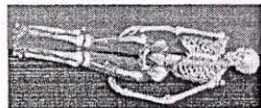
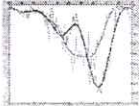

Applications:

- Non-invasive mobile sensor for measuring fluid volume and intracranial pressure
- Wireless non-invasive biosensor screening skin patch to detect blood-flow abnormalities of individuals with peripheral artery disease (PAD)
- Biomechanics of human rolling, increase understanding of how rolling occurs, important for those who have mobility restrictions, prevention of decubitus ulcers
- Spectral analysis for biomarkers of PAD, identification of biochemical alterations and signatures, and severity of muscle damage from muscle biopsies
- Corrosion evaluation of biodegradable metals for the development of next generation cardiovascular stents: magnesium alloy, 316L stainless steel
- Evaluation of surface modifications (coatings, laser micro-machining) on metals (titanium, stainless steel, cobalt-chromium) used for orthopedic implants to prevent infection and improve bone integration
- Computational modeling of an electroactive polymer to improve ejection fraction for individuals with left ventricular systolic dysfunction, a common cause of heart failure
- Development of a smart skin electromagnetic resonant sensor to aid in the early detection of osteopenia

Funding Sources

- NIH - National Institute of Health: K-INBRE
- NSF - National Science Foundation: GARDE, I-CORP Team, EPSCoR
- NASA - National Aeronautics and Space Administration, EPSCoR
- VentureWell
- AHA - American Heart Association

Power Saver Switch

1. Piyush (EEE) - 9505503311 piyushkora29@gmail.com.
2. Vishnu Harshith (CSE) 9618229827 vishnu-damaraju@gmail.com.
3. K.V. NIKHIL (ECE) 8179860329 kvnikhil18@gmail.com
4. M R Abhishek (Mech-2A) 9951581269 abhi20116@gmail.com.
- V. Shima Kumar 8499849483 shivayadavvallala@gmail.com



PRINCIPAL
Geethanjali College of Engg. Techn.
Thesval (V), Kolar (M), R.S. Dist. (A.P.) - 501 900.

GENERATING ELECTRICITY FROM SOUND

Bharadwaj	15R11A0314	Mech 2A	7032911698
Varsha	15R11A0221	EEE	7036775998
Sujana	15R11A0493	ECE 2B	9030819032
Tanmayi	15R11A05A5	CSE 2B	9618706487
P. Vishal Vinay	15R11A0343	ME-2A	9000242484

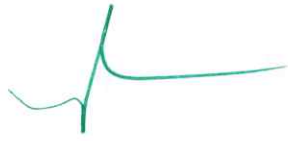

PRINCIPAL
Sreehanjali College of Engg. Tech.
Chandrapur (V), Raesara (M), R.R. Dist. (A.P.) - 501 302

Do It

Prototype of the Application

Developers:

R. Priyanka

Lekhana

Logo

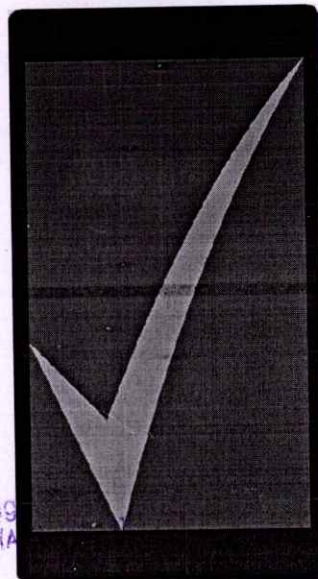

PRINCIPAL
Geethanjali College of Eng
Chennal (V), Keesara (M), R.R. Dist. (A

Screen 2.1

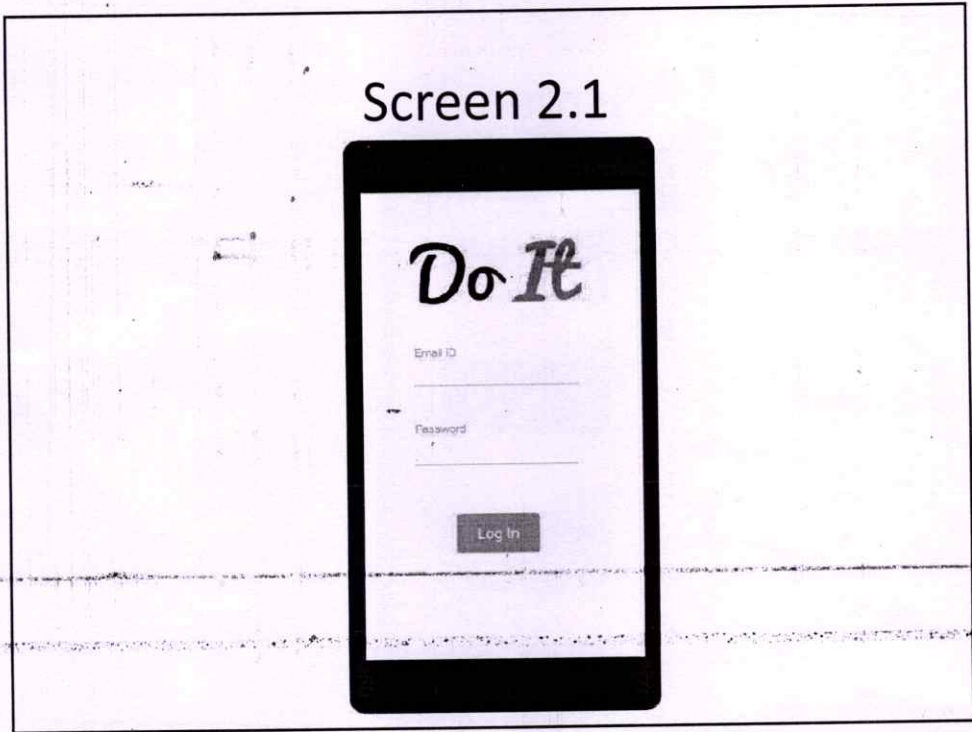

Screen 2.2

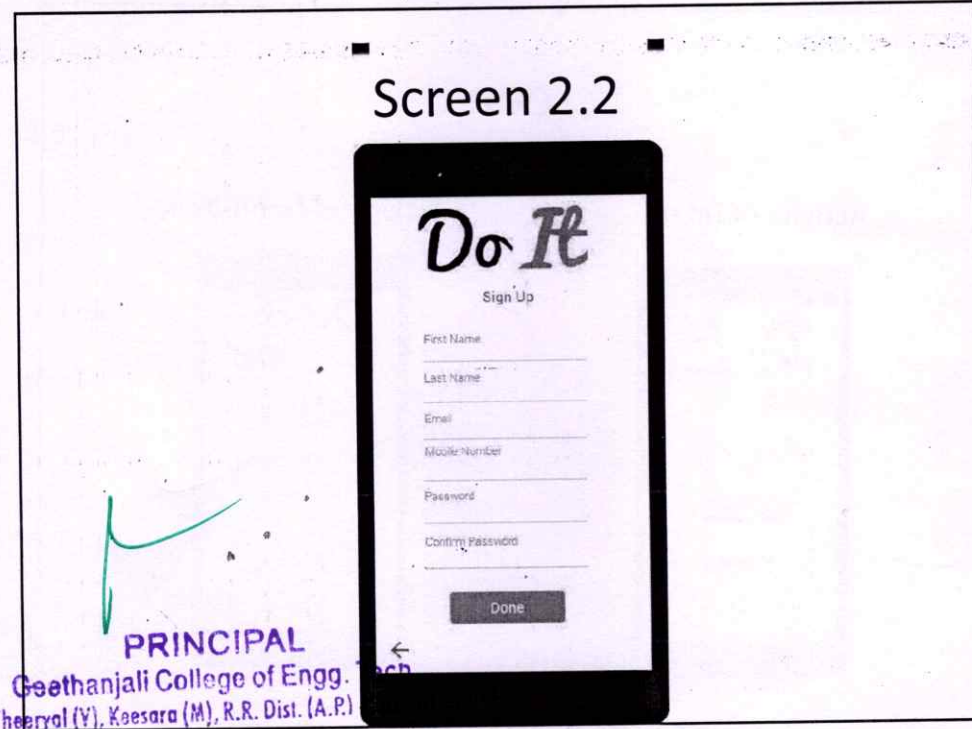

Screen 3.1



Screen 3.2



PRINCIPAL

Geethanjali College of Engg. Tech.

Chennai-600 031, Kanchi (M), P.S. Dist. (A.P.) - 501 301

To,

The Principal

Geethanjali College of Engineering and Technology
Cheeryal, Keesara, Medchal.

Date: 25th April, 2017

Sr,

Subject: Undertaking to participate and register for the Exite Program
By JNTU H

I, Rahul ND, of CSE III C bearing the roll number, 14R11A05F6
was just intimidated about the EXITE Program by JNTU H,
and acknowledge that, I would be willing to perform
as needed.

Therefore, please allow me to join the Program and
I can assure you that I will do my best.

Thanking you.

Yours Faithfully,

Rahul ND - 14R11A05F6

PRINCIPAL
Geethanjali College of Engg. Techn.
Cheeryal (V), Keesara (M), R.R. Dist. (A.P.) - 501 302

EXCITE 17 Nominees from B.Tech CSE

Sl No	Name	Roll No	Branch	Class	Section	Phone No	Email ID
1	Rahul N.D.	14R11A05F6	CSE	III	C	9989164141	rahul1996@gmail.com
2	M. Pooja	14R11A0532	CSE	III	A	8801335027	pooja.kriya1997@gmail.com
3	Madhu Bhargava	14R11A0517	CSE	III	A	8886360836	embspot@gmail.com

EXCITE 17 Nominees from B.Tech ECE

Sl No	Name	Roll No	Branch	Class	Section	Phone No	Email ID
1	Ankati Navya	14R11A0404	ECE	III	A	8790274486	
2	CH. Sai Bhargavi	14R11A0470	ECE	III	B	9440331303	
3	Ambati Siva Sai	14R11A04J3	ECE	III	D	9550275985	

EXCITE 17 Nominees from B.Tech (ECE)

Sl No	Name	Roll No	Branch	Class	Section	Phone No	Email ID
1	M. Sai Krupa Reddy	15R11A0494	ECE	II	B	9642959599	
2	Ambati Chinmayi	15R11A04J1	ECE	II	D	9790111808	
3	D. Sai Jaya Madhuri	15R11A0472	ECE	II	B	7702158763	

PRINCIPAL
 Goethanjali College of Engg. Tech.
 Hooryal (V), Keesara (M), R.R. Dist. (A.P.) - 501 301

Microsoft Word - DC MCQs on Sorting.wit

Institute Signup Form to: X

Secure | https://docs.google.com/forms/d/e/1FAIpQLScTES17DpQd7KH8s4vEXkmW47Hs547FPZhmESRQc9Pyw-RA/viewform?c=0&w=1&includes_info_params=true

Apps

Email Id *

Student coordinator for I-Cell (Preferably from Excite-2017 batch)

Name of the Student Co-ordinator 1 *

Contact Number *

Email Id *

Name of the Student Co-ordinator 2 *

PRINCIPAL
Geethanjali College of Engg. Tech.
Cheeryal (V), Keesara (M), R.R. Dist. (A.P.) - 501 301

M - Hub: ECE Co-ordinator X Institute Signup Form to X
Secure | https://docs.google.com/forms/d/e/1FAIpQLSdEST7DbQd7KHx8s4vEXkmW47Hs547FPZtmESRQc9Pyw-R4/viewform?c=0&w=1&includes_info_params=true
Apps | Microsoft Word - D.C. MCQs on Sorting wit

Name of the Student Co-ordinator 2 *

D. Sai Jaya Madhavi

Contact Number *

7702158763

Email Id *

dmkt.madhavi@gmail.com

Which of the Following Exists in Your College *

EDC

Incubation Centre

Any Other Centre

Activities of the Centre

We have both EDC/NEN and center of in

PRINCIPAL
Geethanjali College of Engg. Tech.
(Cheerloli (V), Keesara (M), R.R. Dist. (A.P.) - 501 302-

[M-JHub: ECE Co-ordinator](#) | [Institute Signup Form to X](#) | [Secure | https://docs.google.com/forms/d/e/1FAIpQLSateST7DpQd7KHx8s4vEXkmW47Hs547FPZtmESRQcPw-RA/viewform?c=0&w=1&includes_info_params=true](#) | [Apps](#) | [Microsoft Word - DC](#) | [MCQs on Sorting wri](#)

Name of the Last held event

E-Week by EDC/NEN. Prototype develop

Date of the Event

Date
04/22/2017

Number of Participants Enrolled

Incubation Center : 110, EDC/NEN: 250

Major Outcome (Highlights of the Event)

8 ideas for societal improvement were formulated. Students are currently working on prototypes. College app on Google was developed. Its been widely used now by students

Did your College Participate in any programmes like (Startup/Fests etc) *

Yes No

PRINCIPAL
 Geethanjali College of Engg. Tech.
 Cheeryl (V), Keesara (M), R.R. Dist. (A.P.) - 501 307

[Home](#) | [ECE Co-ordinator](#) | [Institute Signup Form](#) | [Secure](#) | https://docs.google.com/forms/d/e/1FAIpQLSdEST7DbQd7KH8s4vEXkmW47Hs547FPZtmESRQc9Pjw-RA/viewform?c=0&w=1&includes_info_params=true | [Microsoft Word - DC](#) | [MCQs on Sorting with](#)

Name of the Last held event

E-Week by EDC/NEN, Prototype develop

Date of the Event

Date
04/22/2017

Number of Participants Enrolled

Incubation Center : 110, EDC/NEN: 250

Major Outcome (Highlights of the Event)

8 ideas for societal improvement were formulated. Students are currently working on prototypes. College app on Google was developed. Its been widely used now by students

Did your College Participate in any programmes like (Startup/Fests etc) *

Yes
 No

Geethanjali College of Engg. Tech.
 Cheeryal (V), Keesara (M), R.K. Dist. (A.P.) - 501 306

7

Microsoft Word - DC | Apps | Microsoft Word - DC | MCCs on Sorting will | Institute Signup Form to X | Secure | https://docs.google.com/forms/d/e/1FAIpQLScIEST7DbQd7KH8s4vEXkmW47Hs547FPZtmESRQc9Pww-RA/viewform?c=0&w=1&includes_info_params=true

Did your College Participate in any programmes like (Startup/Fests etc) *

Yes
 No

Any Interesting Prototypes Developed in your Institute *

STARS (SELF TRIGGERING ACCIDENT R

Signature of the principal *

Dr. Udaya Kumar Susarla

I'm not a robot

reCAPTCHA
Privacy Terms

SUBMIT

Never submit passwords through Google Forms.

Principal
Geethanjali College of Engg. Techn.
Cheerlay (V), Kaasara (M), R.R. Dist. (A.P.) - 501 304

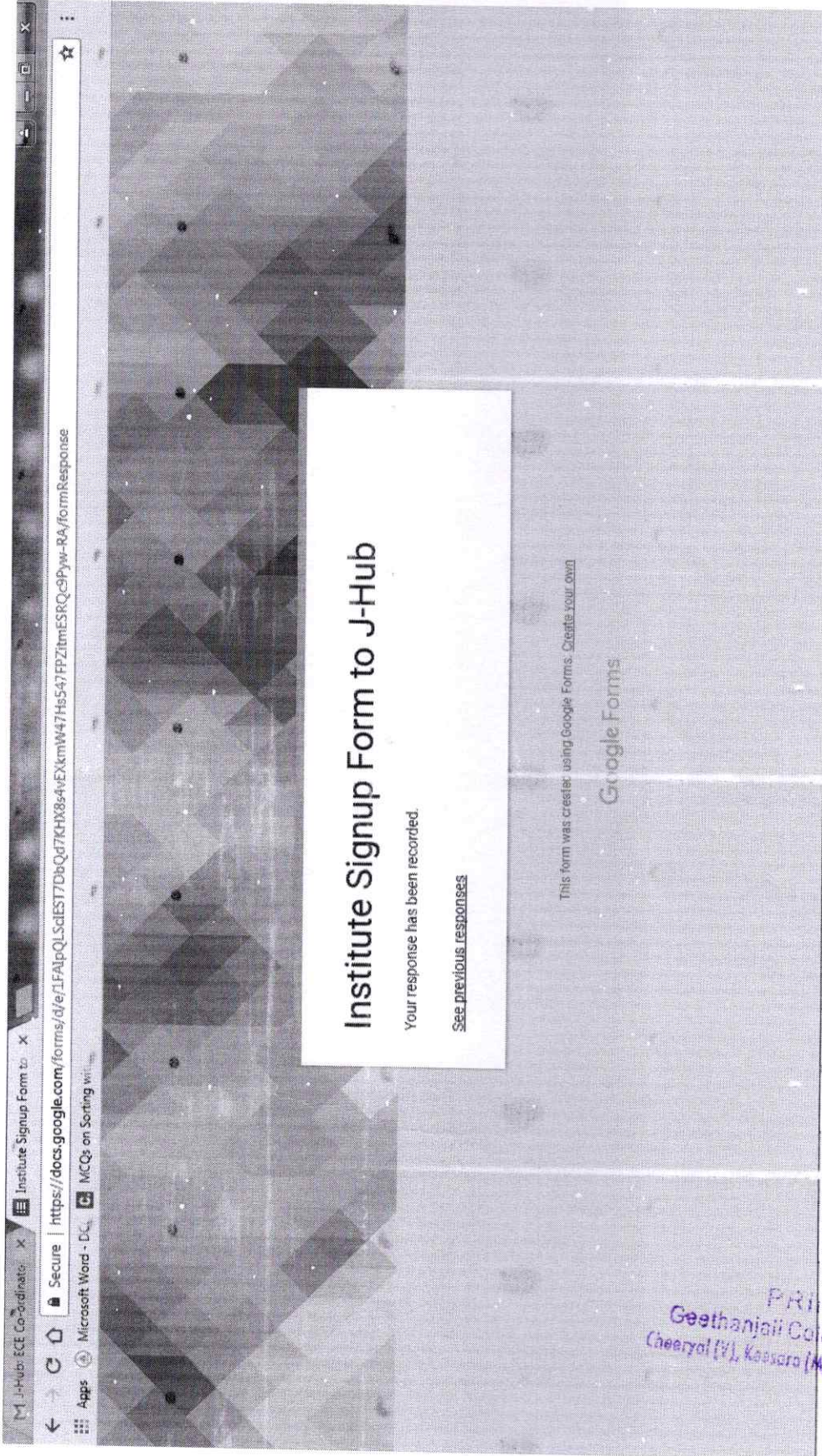

K

PRINCIPAL
Geethanjali College of Engg. Tech.
Cheeryal (V), Kasimkota (M), R.R. Dist. (A.P.) - 501 204.

Microsoft Word on Sorting x | J-Hub: ECE Co-ordinate | Institute Signup Form | Institute Signup Form | Institute Signup Form | Secure | https://docs.google.com/forms/d/e/1FAIpQLScE17DbQd7KH8s4vEXkmW47H5A7FPZtmESRQc9Pw-R4/viewanalytics

Institute Signup Form to J-Hub

6 responses

Name of the Institute

6 responses

Jntuh
IITH
Test1
Jntuh ceh
JNTUJH
Geethanjali College of Engineering and Technology

Faculty (2) identified to coordinate the activities of I-Cell

PROFESSOR
Geethanjali College of Engg. Tech.
 Cheeryal (V), Keasara (M), R.R. Dist. (A.P.) - 501 301



Faculty (2) identified to coordinate the activities of I-Cell

Name of the Faculty Incharge 1

6 responses

Faculty Name	Number of Responses	Percentage
Hemalatha	2	33.3%
N. Chandrakanth	1	16.7%
Supreethi	1	16.7%
tdf	2	33.3%

PRINCIPAL
 Geethanjali College of Engg. Tech.
 Cheeryal (V), Keesara (M), R.R. Dist. (A.P.) - 501 305

J-Hub ECE Co-ordinat... X Institute Signup Form to X
Secure | <https://docs.google.com/forms/d/e/1FAIpQLScLEST7DbQd7KHx8s4vEXkmW47Hs547FPZltimeSRQc9Pw-RA/viewanalytics>
Apps | Microsoft Word - D... | MCQs on Sorting wit

Contact Number

6 responses

gdg	
fdaf	
99990779878	
9949738588	
94400168897	
9885723157	

Email Id

6 responses

rdg@gmail.com
fdaf@gmail.com
abc@gmail.com
ularik1234@gmail.com

PRINCIPAL
Geethanjali College of Engg. Tech.
(Chemical(V), Koesara(M), K.R. Dist. (A.P.) 501201)

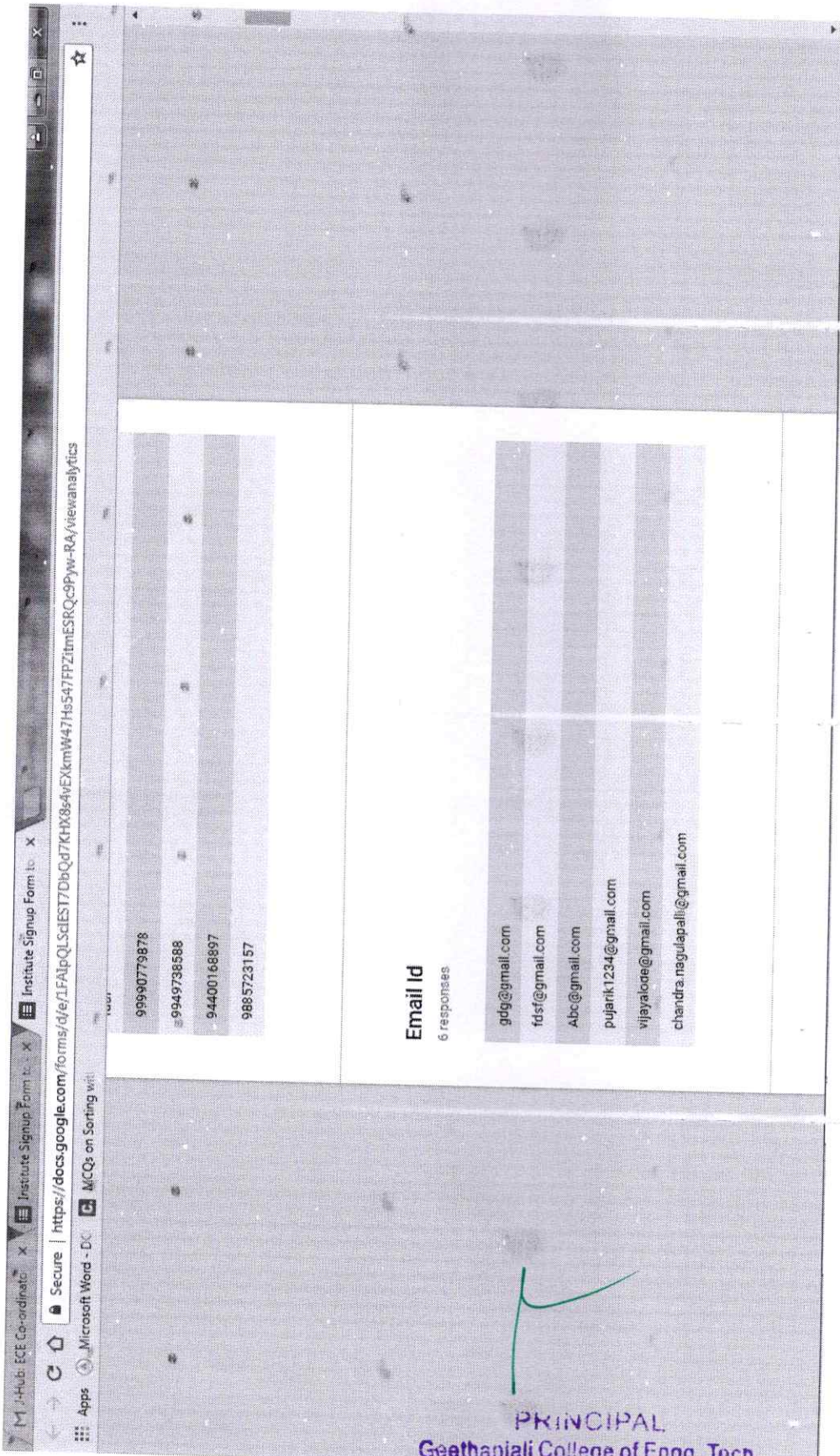

PRINCIPAL
Geethanjali College of Engg. Tech.
Cheeryal (V), Keesara (M), R.R. Dist. (A.P.) - 501 303

GEETHANJALI COLLEGE OF ENGINEERING AND TECHNOLOGY

IGNITE STUDENT LIST

S.No	Name	Roll No	Branch	Phone	Email
1	Jyotishwara Prasad A	17R11A05G4	CSE	9705632126	ajyotish2000@gmail.com
2	M Gokul	17R11A0562	CSE	9704704112	mamandurugokul1@gmail.com
3	Aditya Sharma	1711A05H4	CSE	8639569330	
4	A Sankeerthana	17R11A0451	ECE B	9550306560	sankeerthanaarja@gmail.com
5	Rohit Vishal	17R11A0462	ECE B		
6	P. Uday Sai	17R11A0289	EEE B	9182338865	pillalamarriuday@gmail.com

PRINCIPAL
 Geethanjali College of Engg. Tech.
 Cheeryal (V), Keesara (M), R.R. Dist. (A.P.) - 501 301-

IGNITE WORKSHOP for 1 year B.Tech students

A 3 day intensive workshop on Innovation to inspire 1 year B.Tech students in J-Labs is scheduled during 3rd week of May 2018. One team from each J-Lab shall be nominated of size 3.

* Required

Name of the Team Member_1 *

Jyotishwara Prasad.A

Contact Number *

9705632136

Email Id *

ajyotish2000@gmail.com

Name of the Team Member_2 *

M.Gokul

Contact Number *

9704704112

Email Id *

mamandunugokul1@gmail.com

Name of the Team Member_3 *

Aditya Sharma

Contact Number *

8639567930

Email Id *

PRINCIPAL
Goethanjali College of Engg. Tech.
Cheeryl (V), Keesara (M), R.R. Dist. (A.P.) - 501 301

✓

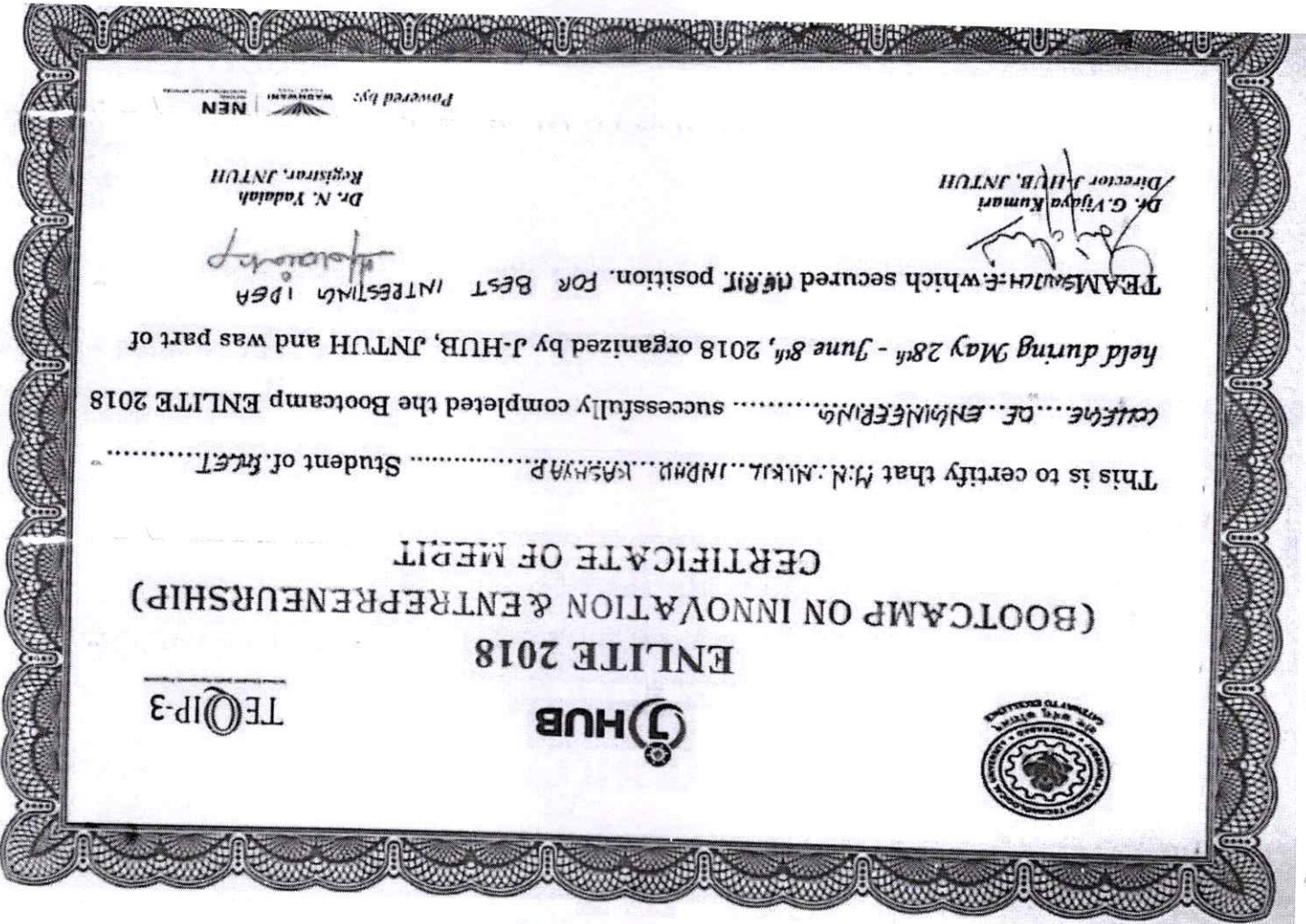

ENLITE 2018
 (BOOTCAMP ON INNOVATION & ENTREPRENEURSHIP)
 CERTIFICATE OF MERIT

PRINCIPAL
 Geethanjali College of Engg. Tech.
 Cheeryal (V), Keesara (M), R.R. Dist. (A.P.) - 501 304

✓

THE UNIVERSITY OF CHICAGO
LIBRARY

Handwritten notes at the top of the page, possibly including a date and some illegible text.

A small handwritten mark or symbol in the center of the page.

A small handwritten mark or symbol in the lower middle section of the page.

A small handwritten mark or symbol in the lower middle section of the page.

A small handwritten mark or symbol in the lower middle section of the page.

[M Hub: ECE Co-ordinator](#) | [Institute Signup Form to X](#) | [Institute Signup Form to X](#) | [Institute Signup Form to X](#) | [https://docs.google.com/forms/d/e/1FAIpQLsctEST7D6Qd7KH8s4vEXkmW47Hs547FPZimESRQc9Pw-RA/viewanalytics](#) | [Microsoft Word - DC](#) | [MCQs on Sorting with](#)

Name of the Faculty Incharge 2

6 responses

Name	Count	Percentage
Hemalatha	1	16.7%
O.V.P.R. Sivekumar	1	16.7%
Vijaya	2	33.3%
abo@gmail.com	1	16.7%
fdf	2	33.3%

Guethanjali College of Engg.
 (Cheeraj (V), Keesara (M), R.A. Dist. (A.P.)-501 302)

Handwritten mark resembling a stylized 'Y' or '2' in green ink.

Contact Number
 6 responses

fdf
fgfdg

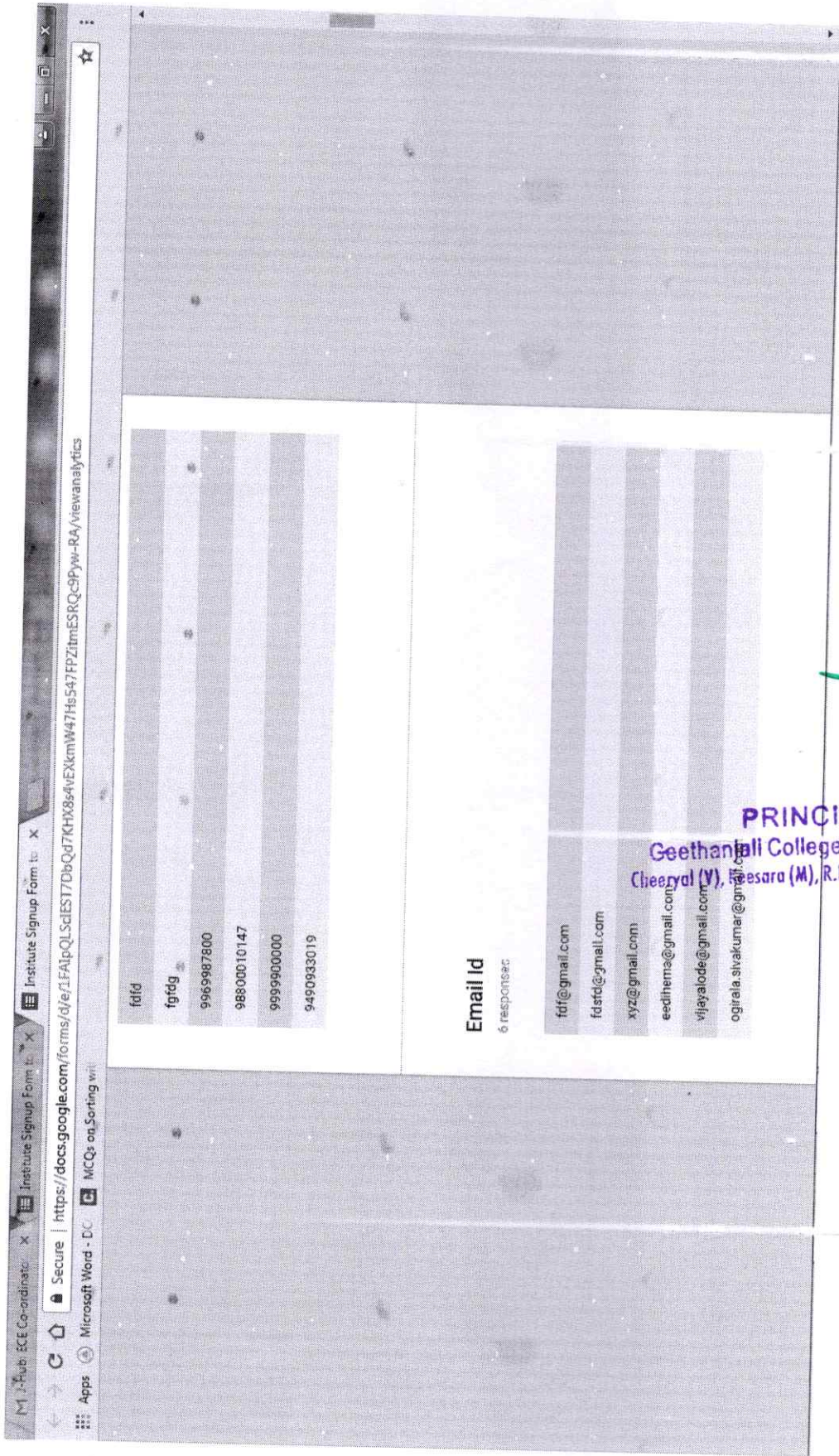

Email Id	response
fdfd	
fgfdg	
9969987800	
98800010147	
9999900000	
9490983019	

Email Id
6 responses

fdf@gmail.com
fdstd@gmail.com
xyz@gmail.com
eedheme@gmail.com
vijayalode@gmail.com
ogirala.sivakumar@gmail.com

PRINCIPAL
Geethanjali College of Engg. Tech.
Cheerayal (Y), P. Kesara (M), R.R. Dist. (A.P.) - 501 301

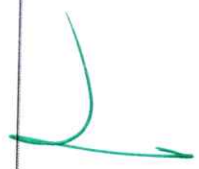

Student coordinator for I-Cell (Preferably from Excite-2017 batch)

Name of the Student Co-ordinator 1
6 responses

fadsfsa
fdsfdf
asads
Ohjk
Vijaya
N.D. Rahul

Contact Number
6 responses

few87r
dfd

PRINCIPAL
Geethanjali College of Engineering
(Cheeryal (V), Keesara (M), R.R. Dist. (A.P.) - 501 301)

Handwritten signature in green ink.

Browser tabs: I-Hub: ECE Co-ordinator, Institute Signup Form, Institute Signup Form, Institute Signup Form, Secure | https://docs.google.com/forms/d/e/1FAIpQLSdEST7DbQg7KHx8s4vEXkmW47Hs547FPZImESRQc9Pww-RA/viewanalytics, Microsoft Word - DC, MCQs on Sorting wv

6 responses

Contact Number
few87r
dfd
88899988898
45678835677
900000090
9999164141

6 responses

Email Id
fdsf3@gmail.com
hgfh@gmail.com
bbb@gmail.com
dfghj@gmail.com
vijayalode@gmail.com

PRINCIPAL
 Gudmanfali College of Engg. Tech.
 Changanassery, Kottayam (M), R.R. Dist. (A.P.) - 501 301

Handwritten signature in green ink.

J-Hub: ECE Co-ordinator X Institute Signup Form Ed X Institute Signup Form Ed X

Secure | <https://docs.google.com/forms/d/e/1FAIpQLSciEST7DbQd7KX00s4vEXkmW47Hs47FPZImESRQc9Pw-RA/viewanalytics>

Apps Microsoft Word - DC MCQs on Sorting with

Name of the Student Co-ordinator 2

6 responses

fdsgf
dfjdlk
aaaaaaaaaaaa
Jhgfda
Aaa
D. Sai Jaya Madhavi

Contact Number

6 responses

543td
fgbv
9090909090
9876543219
8965235426
7702158763

✓

PRINCIPAL
 Gosthanjali College of Engg. Tech.
 Cheeryal (Y), Kausara (M), R.R. Dist. [A.P.] - 501 303

[Institute Signup Form to](#) | [Institute Signup Form to](#) | [https://docs.google.com/forms/d/e/1FAIpQLSdEST7DbQd7KH8s4vEXkmW47Hs547FPZtmeSRQc9Pjw-RA/viewanalytics](#) | [MCQs on Sorting wit](#)

Email Id
6 responses

g4f532@gmail.com
ghfs@gmail.com
uuu@gmail.com
Ghfyjr@gmail.com
Vijyalode@gmail.com
dirnkt.madhavi@gmail.com

Which of the Following Exists in Your College
6 responses

- EDC
- Incubati in Centre
- Any Other Centre

Category	Percentage
Any Other Centre	50.0%
Incubati in Centre	33.3%
EDC	16.7%

PRINCIPAL
 Geethanjali College of Engg. Tech.
 Cheeryal (M), Keeravaram (M), K.R. Dist. (A.P.) - 501 301

✓

Which of the Following Exists in Your College

6 responses

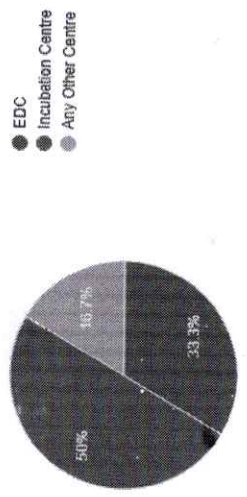

Activities of the Centre

5 responses

hith	
mnm	
asdadadadad	
Programming training	
Wodfg	

PRINCIPAL
 Goethanali College of Engg. Techn.
 Cheeryal (V),
 Resara (M), R.R. Dist. (A.P.) - 501 301

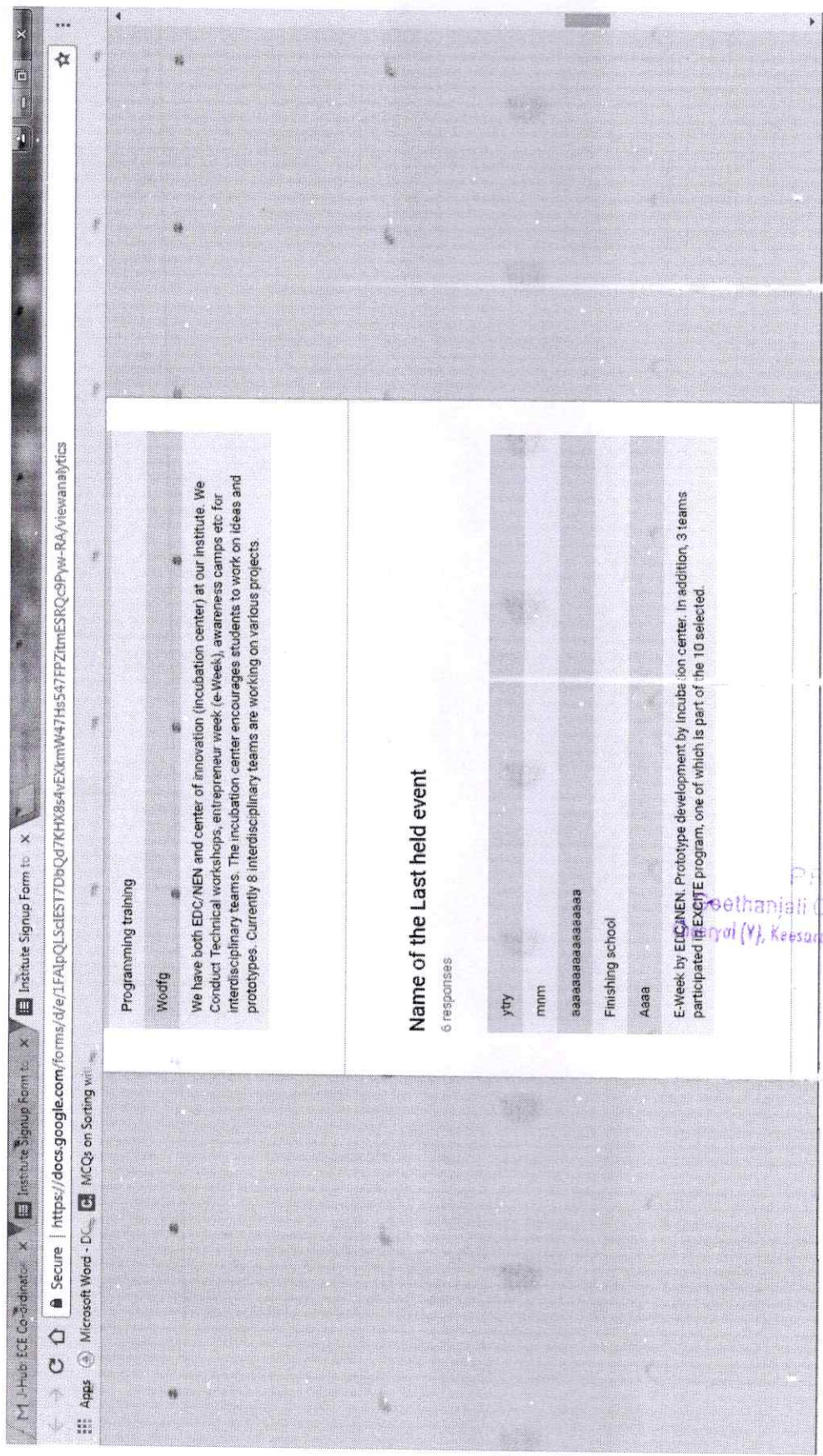

Programming training

Wooffg

We have both EDC/NEN and center of innovation (incubation center) at our institute. We conduct Technical workshops, entrepreneur week (e-Week), awareness camps etc for interdisciplinary teams. The incubation center encourages students to work on ideas and prototypes. Currently 8 interdisciplinary teams are working on various projects.

Name of the Last held event

6 responses

ytry
mnm
aaaaaaaaaaaaaa
Finishing school
Aaaa

E-Week by EDC/NEN. Prototype development by incubation center. In addition, 3 teams participated in EXCITE program, one of which is part of the 10 selected.

PHANAJALI
Phanajali College of Engg. Techn.
Patal (Y), Keerasa (M), R.R. Dist. (A.P.) - 501 301-4

R

Browser tabs: M J-Hub ECE Co-ordinator, Institute Signup Form, Secure | https://docs.google.com/forms/d/e/1FAIpQLSciEST7DbQd7KHx8s4vEXkmW47Hs547FPZtmESRQc9pyw-RA/viewanalytics, Microsoft Word - D..., MCQs on Sorting wi...

Date of the Event
6 responses

Date of the Event	Count	Percentage
Jan 2014	19	
Mar 2017	12	
Apr 2017	22	
Jul 2017	10	12
	18	

Number of Participants Enrolled
6 responses

Number of Participants Enrolled	Count	Percentage
2	3	33%
1	1	16.7%
0	1	16.7%
3	1	16.7%
45	2	30
344	1	16.7%

Incubation Cent...

Geethanjali College of Engg. Tech.
Cheerayal (V), Keesara (M), R.R. Dist. (A.P.) - 501 301

Handwritten mark resembling a stylized '4' or 'u' in green ink.

Major Outcome (Highlights of the Event)

6 responses

ggfrs
 mnvm
 mmmmmmmmmmmmm
 Employability
 Asdf

8 ideas for societal improvement were formulated. Students are currently working on prototypes. College app on Google was developed. Its been widely used now by students

Did your College Participate in any programmes like (Startup/Fests etc)

6 responses

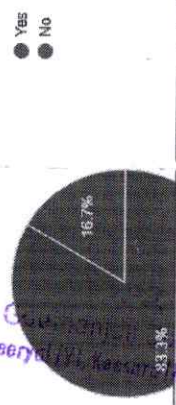

Cheeryal (V. Kamaraju), R.R. Dist. (A.P.) - 501 306
 College of Engg. Tech.

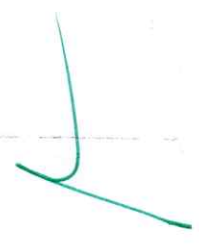

Microsoft Word - DC MCQs on Sorting w... Institute Signup Form t... Institute Signup Form t... Institute Signup Form t...

Secure | <https://docs.google.com/forms/d/e/1FAIpQLScE17DbQd7KH8s4vEXmW47Hs547FPZtmeSRQc9Pw-RA/viewanalytics>

Apps

● Yes
● No

Response	Percentage
Yes	83.3%
No	16.7%

Any Interesting Prototypes Developed in your Institute

6 responses

fdgds	
gh	
mimmm	
Not yet	
Yes	

STARS (SELF-TRIGGERING ACCIDENT RESPONSE SYSTEM), Spray Copter. (These 2 projects were ranked in top 5 at CSI 50th Anniversary Convention), Geethanjali College App.

Geethanjali
Channarayana (V),
Geethanjali College, R.R. Dist. (A.P.) - 501 301



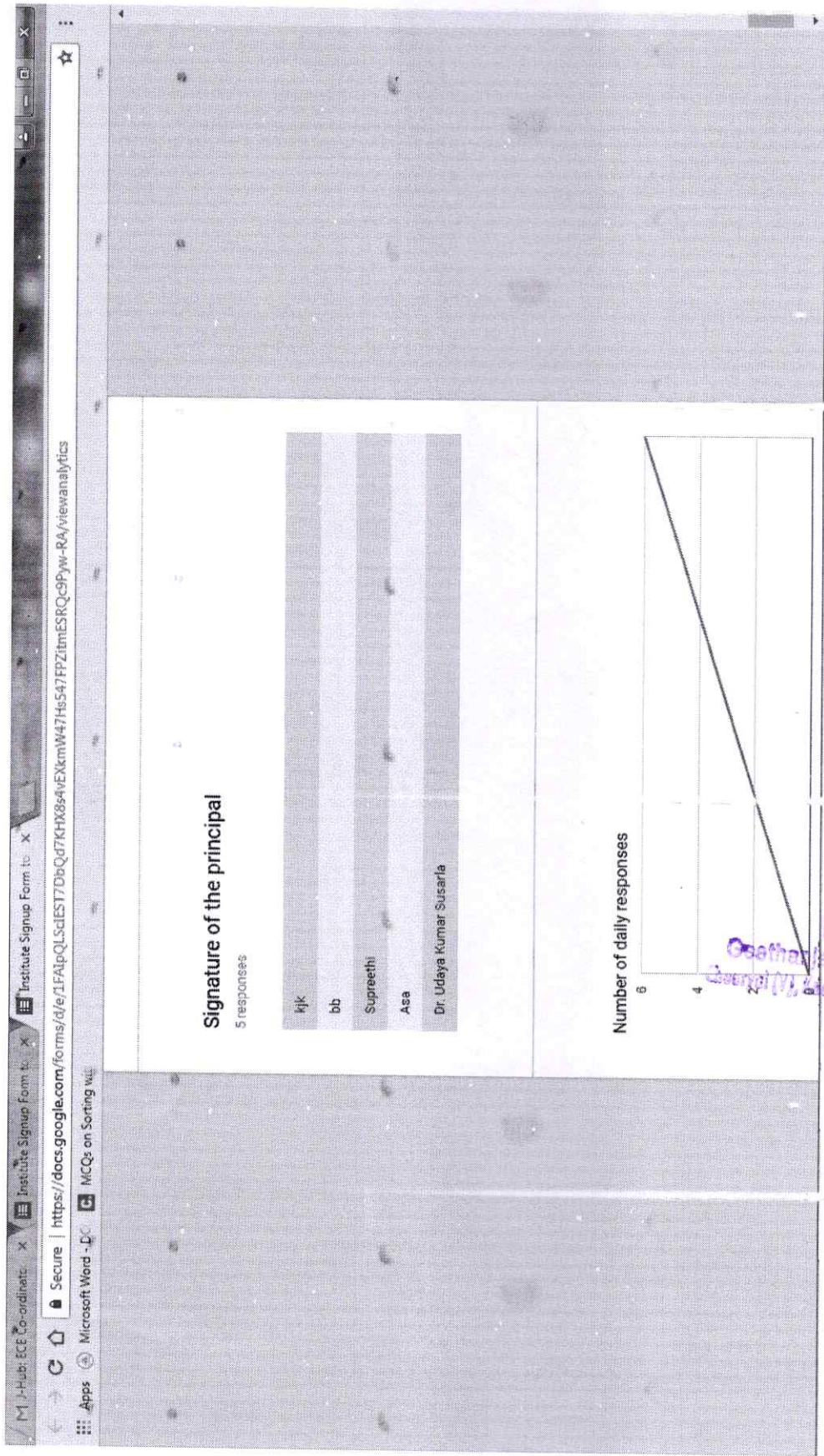

Signature of the principal

5 responses

kjk
bb
Supreethi
Aaa
Dr. Udaya Kumar Susarla

Number of daily responses

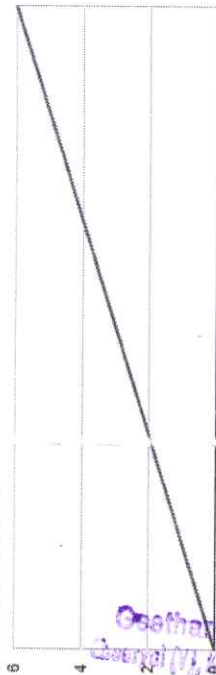

PRINCIPAL
Osetha College of Engg. Tech.
Chennai (V), Secare (H), R.R. Dist. (A.H) 501 302

M J-Hubi ECE Co-ordinator X Institute Signup Form to X Institute Signup Form to X
Secure | https://docs.google.com/forms/g/e/_1FAIpQLSciEST7DbQb7KHx8s4vEXkmW47Hs547FPZtmESRQC9Pyw-RA/viewanalytics
Microsoft Word - DC MCQs on Sorting.Wml

bb
Supreethi
Asa
Dr. Udaya Kumar Susarla

Number of daily responses

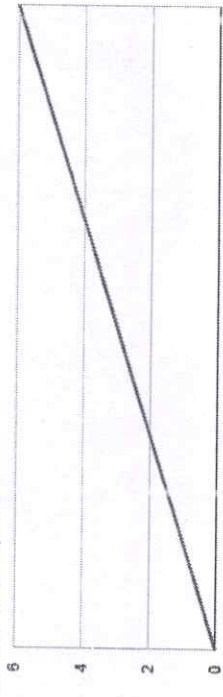

Date	Number of daily responses
Jul 18, 2017	0

This content is neither created nor endorsed by Google. Report Abuse - Terms of Service - Additional Terms

Google Forms

PRINCIPAL
Geethanjali College of Engg. Tech
Cheeryal (V), Kasaragod (M), R.R. Dist. (A.C) 691 487.

[Handwritten signature]

Chat History JHUB - SPOC

2/17/18, 19:35 - Messages to this group are now secured with end-to-end encryption. Tap for more info.
 2/17/18, 15:42 - +91 99080 13310 added group "JHUB-SPOC-2018"
 2/17/18, 19:35 - +91 99080 13310 added you
 2/17/18, 19:35 - +91 99080 13310 added +91 94410 08127 and +91 99597 01905
 2/17/18, 19:35 - +91 98490 92378 left
 2/17/18, 19:35 - +91 99080 13310 added +91 90004 44578 and +91 96528 82100
 2/17/18, 19:35 - +91 99080 13310 added +91 98857 63371
 2/17/18, 19:35 - +91 99080 13310 added +91 93906 38524, +91 98485 32799, and +91 98496 12432
 2/17/18, 19:35 - +91 99080 13310 added +91 80081 11014, +91 98495 54882, and +91 99596 13556
 2/17/18, 19:35 - +91 99080 13310 added +91 92465 45486, +91 94404 18374, and +91 98495 24535
 2/17/18, 19:35 - +91 99080 13310 added +91 99453 99533
 2/17/18, 19:35 - +91 99080 13310 added +91 98668 53636 and +91 99497 38588
 2/17/18, 19:35 - +91 99080 13310 added +91 92461 73939, +91 94409 36885, and +91 94913 39692
 2/17/18, 19:35 - +91 99080 13310 added +91 94406 88833 and +91 98484 35073
 2/17/18, 19:35 - +91 99080 13310 added +91 98663 01801
 2/17/18, 19:35 - +91 99080 13310 added +91 99088 53084
 2/17/18, 19:35 - +91 99080 13310 added +91 99443 08058
 2/17/18, 19:35 - +91 99080 13310 removed +91 98484 35073
 2/17/18, 19:35 - +91 98663 01801 left
 2/17/18, 19:35 - +91 99080 13310 added +91 98663 01501
 2/17/18, 16:15 - +91 99597 01905: Thank you Hema!
 2/17/18, 16:16 - +91 99597 01905: Put the shortlisted teams list in the group
 2/17/18, 16:16 - +91 99080 13310: Dear Group members
 Welcome to the group. This group is for further communication regarding Jhub and Jcell Activities.
 2/17/18, 16:17 - +91 99596 13556: Waiting for this message
 2/17/18, 16:17 - +91 98495 54882: Please add Dr Madan from our college
 +91 99443 08058
 2/17/18, 16:17 - +91 80081 11014: Thank you.
 2/17/18, 16:17 - +91 98495 54882: Thank you very much for adding
 2/17/18, 16:18 - +91 98495 54882: Dr Padmaja, Principal, VJIT
 2/17/18, 16:18 - Udaya Kumar Sir Gcet: Thank you for adding me to the group
 Regards
 Principal of Geethanjali College of Engineering and Technology
 2/17/18, 16:19 - Chandrakanth Sir.gcet: Thank you for the invitation Ma'am, this is Prof Chandrakanth from geethanjali
 2/17/18, 16:21 - +91 99080 13310: <Media omitted>
 2/17/18, 16:22 - +91 99080 13310: Dear All
 Please find the attached file regarding short listed teams for Boot Camp and Hackathon.
 2/17/18, 16:24 - +91 99080 13310: Congratulations to the Teams. You are hereby informed to come for Boot camp
 scheduled on 19th and 20th, February 2018 at First Floor, Jhub Office, New Admissions Block, JNTUH.
 2/17/18, 16:25 - +91 99080 13310: Requesting SPOCS to please share the above information to the students who selected
 for Boot camp.
 2/17/18, 16:30 - +91 99597 01905: Pls be informed that teams not in the shortlist would have another program wherein
 their ideas will be mentored for further refinement. The exact dates will be informed in due time. Look forward to see you all at
 JHub. Request the SPOCs to communicate the same to the registered teams.
 2/17/18, 16:37 - +91 99481 25929: Thank you Madam.
 2/17/18, 16:37 - +91 99481 25929: S.KannaRao, ACE Engg College..
 2/17/18, 16:38 - Harish EEE Gcet: Thank you madam for the invitation
 Dr. Harish pulluri
 From Geethanjali college of engineering and technology
 2/17/18, 17:22 - Siva Kumar Ovpr: Thank you ma'am. I am Prof.Sivakumar from Geethanjali College of Engineering and
 Technology
 2/17/18, 17:27 - +91 90109 63013: What will be agenda and content of this camp madam?
 2/17/18, 17:27 - +91 90109 63013: Thank u madam for adding...
 Maruti,KITS
 2/17/18, 17:30 - +91 87900 18470: Thank you madam, I am Dr.Sreevani from MGIT
 2/17/18, 17:35 - +91 90306 80515: Thank you madam for adding Rajitha Ace engg college
 2/17/18, 18:05 - +91 98663 01501: I didn't receive any message madam
 2/17/18, 18:07 - +91 99088 53084: ðŸ˜ˆ
 2/17/18, 18:24 - +91 97011 84442: Thank u Hema Latha madam for adding us..
 From GNITS

PRINCIPAL
 Geethanjali College of Engg. Tech.
 Chaeryl (V), Keesara (M), R.R. Dist. (A.P.) - 501 304

SEARCHING FOR SPORTS HEADLINES AND SCORES

- â- CBS SportsLine (www.sportsline.com)
- â- CNN/Sports Illustrated (sportsillustrated.cnn.com)
- â- ESPN.com (espn.go.com)
- â- FOXSports (foxsports.lycos.com)
- â- NBC Sports (www.nbcsports.com)
- â- The Sporting News (www.sportingnews.com)

SEARCHING FOR MEDICAL INFORMATION

- â- healthAtoZ.com (www.healthatoz.com)
- â- kidsDoctor (www.kidsdoctor.com)
- â- MedExplorer (www.medexplorer.com)
- â- MedicineNet (www.medicinenet.com)
- â- National Library of Medicine (www.nlm.nih.gov)
- â- Planet Wellness (www.planetwellness.com)
- â- WebMD Health (my.webmd.com)

JOURNALS

- <http://www.indexcopernicus.com> Multidisciplinary
- <http://www.ajol.info/> - African Journal Online
- www.africanjournalseries.com -
- www.devconsortservices.com.ng
- www.doaj.org - directory of open access journal
- www.sabinet.co.za - South African Journals.
- www.oajse.com - Open Access Journal Search Engine
- <http://www.lub.lu.se/en.html> - Lund University
- <http://www.dovepress.com/> - Free Scientific & Medical Materials
- <http://www.copernicus.org/> - Access & Publication

ACADEMIC SEARCH/WEB RESEARCH TOOLS/REFERENCE MANAGERS

- <http://academic.research.microsoft.com> - Multidisciplinary
 - <http://www.scirus.com>
 - www.scholar.google.com
 - <http://dbis.uni-trier.de/DBL-Browser/> - Digital Bibliography Library Browser
 - <http://academic.live.com> - Live Search Academic
 - <http://www.science.gov/> - USA government for Science
 - <http://citeseerx.ist.psu.edu/index> - Computing & Information Sciences
 - <http://www.mendeley.com/> - academic social network/collaboration
 - <http://www.worldcat.org/> - Multidisciplinary
 - <http://libserver.cedefop.europa.eu> - Voc & Tech Education
 - <http://inspirehep.net/> - Stanford physics information retrieval system
 - <http://www.ssrn.com/> - Social Science Research Network. M.Ravichandran.VKR PHARMA KRISHNAGIRI
 - 2/22/18, 17:02 - â€+91 99597 01905â€-: Heads Up for the Hackathon on CYBER PHYSICAL SYTEMS and INDUSTRY 4.0 at JHub scheduled tomorrow.
 - 2/22/18, 17:03 - â€+91 99597 01905â€-: All teams in List1 and List 2 are required to report at 9am at JHUB 1st floor admission block JNTUH campus
 - 2/22/18, 17:04 - â€+91 99597 01905â€-: The Hackathon is 36hrs overnight and the valedictory is scheduled at 4pm on 24th Feb Sarurday.
 - 2/22/18, 17:06 - â€+91 99597 01905â€-: The SPoCs are requested to ensure the teams are reporting with the required laptops/hardware/sensors etc required for their prototypes.
 - 2/22/18, 17:08 - â€+91 99597 01905â€-: The SPoCs, any interested parents are welcome to give any moral support during the overnight hackathon.
 - 2/22/18, 17:09 - â€+91 99597 01905â€-: Wishing all the teams a rewarding experience at the HACKATHON !
 - 2/26/18, 17:56 - â€+91 99597 01905â€- added â€+91 94901 41230â€-
 - 2/26/18, 13:00 - â€+91 99080 13310â€-: Dear Sir/Madam.
- The second meeting of the Institution Coordinators is scheduled on March 3rd, 2018 at 10:30am at JHUB , 1st floor Admission block JNTUH campus.

PRINCIPAL
Geethanjali College of Engg. Tech.
Georoyal (V), Keerasa (M), R.R. Dist. (A.P.) - 501301.

3/8/18, 19:26 - +91 93906 38524: Hey guys.....ready to take up the biggest hackathon of the planet ??.. Here's the chance to prove yourself. NASA representative SUVMN is conducting the NASA space Apps challenge at SNIST this March on 15th & 16th. The hackathon is as follows

PHASE 1

Hackathon @College/School
College/School conducted Hackathon/Space Fair
Themes were given by organizing team
Nomination of top three teams from each College/School

PHASE 2

Hackathon @ T-Hub
Centralized Hackathon for all winning teams from College/School
Challenges were given by NASA
Top teams to be nominated to NASA

PHASE 3

NASA Space Accelerator
NASA to take a call on all top teams across the world and select Winners
Global Recognition
NASA Space App Accelerator

BENEFITS

Opportunity to nominate three teams for central hackathon
NASA Student Certificate to all participants
NASA Certificate to Host College
NASA Zonal Winner Certificate to the college winners

So gear up and let us hear from you

Register at <https://goo.gl/forms/dYh7Kcp395CXX3efl>

For any details contact:

Pallavi - +91 95336 06174

Kiran - +91 9000723387

Gaurav - +91 7702195915

3/8/18, 19:26 - +91 93906 38524: <Media omitted>

3/9/18, 16:52 - +91 94901 41230: <Media omitted>

3/9/18, 16:52 - +91 94901 41230: The following list is being updating in the web site. Please notify any changes.

3/9/18, 17:02 - +91 90101 80199: Srinivas ji, Pls update my name...

Dr. Y.J.Nagendra Kumar

Professor

GRIET

3/9/18, 17:03 - +91 94901 41230: Ok

3/9/18, 17:36 - +91 94913 39692: Update my name as Dr. P. Swetha, email id : swetha.perumalla1@gmail.com

3/9/18, 17:37 - +91 94913 39692: Update my name as Dr. P. Swetha, email id : swetha.perumalla1@gmail.com from JNTUHCEJ

3/9/18, 17:37 - +91 94901 41230: Ok madam

3/12/18, 12:21 - +91 99480 49293: <Media omitted>

3/12/18, 13:52 - +91 99597 01905: Dear All , Hope students are able to register and send ideas to Aspiring Women Entrepreneurs program with IC2 institute , University of Texas. Last date in 16th March. Pl encourage students to apply. They will get many opportunities to connect to experts in addition to the summer internship.

3/12/18, 13:52 - +91 99497 38588: OK madam

3/12/18, 14:00 - +91 94404 48924: Madam definitely convey the information to students.

3/13/18, 10:21 - +91 96768 67222: For the Under Graduate Summit

Sphoorthy Engineering College got nominated for 3 Awards

- 1) Best Emerging College
- 2) Best participation in the Events
- 3) Best Academic Performer

PRINCIPAL
Geethanjali College of Engg. Tech.
Cheerayal (V), Keesara (M), R.R. Dist. (A.P.)

4/4/18, 21:44 - â€³+91 99088 53084â€³: ðŸˆ¸
4/4/18, 21:44 - â€³+91 99088 53084â€³: Congratulations Madam
4/4/18, 22:00 - â€³+91 91603 29739â€³: Sir can u share the website address
Sorry iam not finding it in Google
4/4/18, 22:02 - â€³+91 94901 41230â€³: www.jhub.ac.in
4/4/18, 22:03 - â€³+91 91603 29739â€³: Thank you sir
4/6/18, 15:00 - â€³+91 92465 60870â€³: Good afternoon. can you please add the following members to the group.
4/6/18, 15:00 - â€³+91 92465 60870â€³: Mr Narendersingh Singh
9014067636
Dr Sudheer Reddy
9160017017
4/6/18, 15:00 - â€³+91 92465 60870â€³: 2 faculty will come from Anurag Group mam
4/6/18, 15:01 - â€³+91 99480 49293â€³: I will be attending mam from GRIET

Pradeep Reddy G

4/6/18, 15:01 - â€³+91 94938 65036â€³: Good Afternoon Madam. One faculty will be coming from Sphoorthy Engineering College.
4/6/18, 15:03 - â€³+91 81798 27400â€³: 3 Faculty will be coming from BVRIT HYDERABAD mam.
4/6/18, 15:08 - â€³+91 99595 59905â€³: Good afternoon

Kindly add the following number to the group

Dr M Sreevani

8790018470

MGIT

4/6/18, 15:54 - â€³+91 93906 38524â€³: Myself and Mr.Dheeraj will be joining for the meeting.

Dr. Ameet Chavan

4/6/18, 16:16 - â€³+91 98495 54882â€³: From VJIT M Goutham would be attending

4/6/18, 16:17 - â€³+91 98490 24369â€³: Two faculty from Nalla Malla Reddy Engineering College

4/6/18, 16:38 - â€³+91 92465 45486â€³: This message was deleted

4/6/18, 16:51 - â€³+91 92465 45486â€³: Two faculty from VBIT

4/6/18, 17:11 - â€³+91 90307 51024â€³: Two faculty members from VNRVJIT

4/7/18, 14:24 - â€³+91 94901 41230â€³ added â€³+91 97054 49268â€³

4/7/18, 14:25 - â€³+91 94901 41230â€³ added â€³+91 98663 01501â€³

4/7/18, 12:45 - â€³+91 94901 41230â€³: <Media omitted>

4/7/18, 12:46 - â€³+91 99088 53084â€³: <Media omitted>

4/7/18, 12:46 - â€³+91 99088 53084â€³: <Media omitted>

4/7/18, 12:46 - â€³+91 99088 53084â€³: <Media omitted>

4/7/18, 15:21 - â€³+91 98495 24535â€³' s security code changed. Tap for more info.

4/7/18, 16:08 - â€³+91 99590 05038â€³ changed to +91 77801 17200

4/8/18, 18:16 - â€³+91 94938 65036â€³: Madam, please share the slides of Saturday's meeting.

4/8/18, 18:16 - â€³+91 94938 65036â€³: shwetamanghani14@gmail.com

4/8/18, 18:35 - â€³+91 91603 29739â€³: @919490141230 sir plz keep our jhub logo as DP

4/8/18, 20:03 - â€³+91 99597 01905â€³ changed this group's icon

4/9/18, 16:41 - â€³+91 98495 24535â€³' s security code changed. Tap for more info.

4/9/18, 21:29 - â€³+91 98495 24535â€³' s security code changed. Tap for more info.

4/10/18, 09:59 - â€³+91 99666 72730â€³: Any updates on coming events like boot camp, exite

4/10/18, 10:10 - â€³+91 99597 01905â€³: Registrations will open today. Will send you the link once it is putup

4/10/18, 10:31 - â€³+91 99666 72730â€³: Ok madam

4/10/18, 12:56 - â€³+91 94938 65036â€³' s security code changed. Tap for more info.

4/10/18, 17:14 - â€³+91 94901 41230â€³ changed this group's icon

4/10/18, 17:10 - â€³+91 94901 41230â€³: Registrations for summer programmes is open. Please refer your mail for details.

Registrations can be done from the website www.jhub.ac.in

4/11/18, 16:05 - â€³+91 81798 27400â€³: Anwar Pasha BVRITH.vcf (file attached)

4/11/18, 16:05 - â€³+91 81798 27400â€³: @919490141230 sor, pl add Anwar Sir, He is our college EDC cell Incharge

4/11/18, 16:05 - â€³+91 81798 27400â€³: *sir

4/12/18, 13:03 - â€³+91 94901 41230â€³ added â€³+91 94402 15230â€³

4/12/18, 13:13 - â€³+91 94901 41230â€³ added â€³+91 97013 52066â€³

4/12/18, 12:40 - â€³+91 94901 41230â€³: Applications for Startup Accelerator can be made at www.jhub.ac.in. The programme is meant for students passing out June 2018

4/12/18, 15:45 - â€³+91 80081 11014â€³: Dear Mr. Srinu, I have not received any mail regarding registration.

PRINCIPAL
Geethanjali College of Engg. Techn.
Chowryal (V), Kaasara (M), R.R. Dist. (A.P.) - 501 301

4/26/18, 13:56 - â€+91 99088 53084â€-: Okay Madam, good decision
4/27/18, 12:49 - â€+91 90307 51024â€-: Who all are attending this session today? I'm here.
4/27/18, 13:44 - â€+91 99666 72730â€-: <Media omitted>
4/28/18, 20:01 - â€+91 80081 11014â€-: *Workplace rules for happy life:*

1. *Trust no one* but respect everyone.
2. What happens in office, remain office. *Never take office gossips* to home and vice versa.
3. *Enter office on time, leave on time*. Your desktop is not helping to improve your health.
4. *Never make Relationships* in the work place. It will always backfire.
5. *Expect nothing*. If somebody helps, feel thankful. If not, you will learn to know things on your own.
6. *Never rush for a position*. If you get promoted, congrats. If not, it doesn't matter. You will always be remembered for your knowledge and politeness, not for your designation.
7. *Never run behind office stuff*. You have better things to do in life.
8. *Avoid taking everything* on your ego. Your salary matters. You are being paid. Use your assets to get happiness.
9. It *doesn't matter how people treat you*. Be humble. You are not everyone's cup of tea.
10. In the end *nothing matters except family*, friends, home, and Inner peace.

World's Mental health day theme by WHO.
Mental Health at work place

<http://www.who.int/>

[mental_health/world-mental-health-day/2017/en/](http://www.who.int/mental_health/world-mental-health-day/2017/en/)

4/30/18, 18:20 - â€+91 90307 51024â€-'s security code changed. Tap for more info.

4/30/18, 23:15 - â€+91 98666 19887â€-'s security code changed. Tap for more info.

5/2/18, 12:31 - â€+91 99597 01905â€-: Hello everyone. The SPoC meeting of May 2018 is scheduled on 5th May Saturday at 11am. Kindly make it convenient to attend the same. A line of confirmation is highly solicited.

5/2/18, 12:34 - â€+91 99597 01905â€-: The Agenda of the meeting is as follows

1. Schedule of Summer Programs.
2. Orientation on Pre-workshop assignments.
3. How to evaluate and mentor ideas.

5/2/18, 20:38 - Chandrakanth Sir.gcet: Ma'am one SPOC from Geethanjali will attend the meeting

5/2/18, 21:00 - â€+91 99597 01905â€-: Ok. Hope he knows the ideas submitted by the students.

5/2/18, 21:45 - â€+91 94938 65036â€-: Please add Manjunath Kempar of Sphoorthy Engineering College in the group. Thankyou.

5/2/18, 21:45 - â€+91 94938 65036â€-: Manju Kempar Sphn.vcf (file attached)

5/3/18, 00:15 - â€+91 92461 73939â€- left

5/3/18, 08:48 - â€+91 98850 16061â€-: ðŸ‘Ÿ' ðŸ‘Ÿ' ðŸ‘Ÿ' ðŸ‘Ÿ'

5/3/18, 11:05 - â€+91 94901 41230â€-: Dear all, please indicate the number of coordinators attending the meeting so as to make lunch and other logistics arrangements.

5/3/18, 11:12 - â€+91 98492 75094â€-: Dear sreenu

5/3/18, 11:15 - â€+91 98492 75094â€-: Dear sreenu one SPOC is going to attend from ACE Engineering college

5/3/18, 11:17 - â€+91 94402 15230â€-: Two members from BVRITH

5/3/18, 12:17 - â€+91 90101 80199â€-: 1 from GRIET

5/3/18, 13:07 - â€+91 92465 45486â€-: 2 members from VBIT

5/3/18, 13:12 - â€+91 80081 11014â€-: 2 members from VJIT

5/3/18, 13:13 - â€+91 98490 24369â€-: Two Members from Nalla Malla Reddy Engineering College(NMREC)

5/3/18, 14:26 - â€+91 93906 38524â€-: Two faculty from snist will be attending

5/3/18, 15:33 - â€+91 94938 65036â€-: One faculty from Sphoorthy Engineering College.

5/3/18, 15:36 - â€+91 99595 59905â€-: One from MGIT

5/3/18, 15:50 - â€+91 99666 72730â€-: Dear Madam, one from GNITS.

5/3/18, 18:41 - â€+91 90307 51024â€-: I'll be the only one attending from VNRVJIET, ma'am

5/3/18, 22:44 - â€+91 98666 19887â€-'s security code changed. Tap for more info.

Based on the requests from the institutions the application for Startup Accelerator is open. Screening committee is expected to be held during last week of May, 2018. You are requested to send any application latest by 25.05.2018 to participate in the screening.

Visit: www.jhub.ac.in

5/14/18, 15:14 - â€+91 94913 39692â€-: EXCITE. 17.05.2018 TO 30.06.2018

BOOTCAMP. 28.05.2018 TO 08.06.2018

IGNITE. JUNE 21,22,23, 2018

5/16/18, 10:38 - â€+91 99481 25929â€-: Dear Madam, Good Morning.Can you inform about Tomorrow's EXCITE program Venue.

5/16/18, 10:56 - â€+91 94901 41230â€-: EXCITE programme venue: J-HUB, JNTUH

5/16/18, 11:32 - â€+91 94901 41230â€-: Dear All,

The EXCITE 2018 programme is scheduled from 17.05.2018 to 30.06.2018. All the students who have registered and submitted assignments are required to report at 10.00 a.m. in J-HUB, JNTUH. The assignments will be reviewed by the panel and finalization of ideas to be taken up will be curated by experts. Formal inauguration is being planned after the finalization of ideas.

The SPoCs are advised to encourage the students and provide advices from time to time. They are welcome for the entire workshop to track the progress of the teams.

5/16/18, 11:57 - â€+91 98486 22979â€-: Dear madam this is Praveen from VJIT. as already I informed about our students that they have exams till 23rd may and they will join from 24th may

Thank you

5/17/18, 19:38 - â€+91 90307 51024â€-: Please share the link to the Google Drive for EXCITE assignments.

5/17/18, 21:31 - â€+91 98492 75094â€-: Kindly provide Google link. Students are asking about link

5/17/18, 22:15 - â€+91 99597 01905â€-: https://drive.google.com/drive/folders/1VTn1j008-mysUTsqo_LqJduWiBE8b_H1?usp=sharing

5/20/18, 08:23 - â€+91 99597 01905â€-: <Media omitted>

5/20/18, 08:30 - â€+91 99597 01905â€-: Good morning everyone. As the ViceChancellor Sir is busy we have blocked his time for formal inaugural of EXCITE 2018 on Tuesday morning. Pl block your calender for attending the Inaugural session on 22nd May in the morning. The exact time and Agenda will be sent tomorrow.

5/20/18, 11:29 - â€+91 99080 13310â€-: ðŸˆ¸

5/20/18, 11:54 - â€+91 90307 51024â€-: Great! Thank you for the information, ma'am.

5/20/18, 12:54 - â€+91 94404 48924â€-: Thank you for the invitation madam. Will be antucupating for schedule.

5/21/18, 12:04 - â€+91 99597 01905â€-: Good morning everyone. As you are all kindly aware that the ideas submitted by the student teams are being curated by mentors thru pre-workshop assignmnets and the students have finalized on their ideas and exploring technologies for implemmentation.

5/21/18, 12:14 - â€+91 99597 01905â€-: In this connection I request you all to kindly join for the Inaugural Function of the EXCITE 2018 workshop tomorrow the 22nd May 2018 at 10:30am in the UGC-HRDC Auditorium JNTUH.

Hon'ble Vice -Chancellor JNTUH has consented to be Chief Guest of the function.

5/21/18, 12:16 - â€+91 99597 01905â€-: Rector JNTUH, Registrar JNTUH and Steering committee will be other key speakers on the occasion.

5/22/18, 11:43 - â€+91 99666 72730â€-: Q : What is Nipah Virus ?

A : Nipah virus was initially discovered when it caused an outbreak of brain fever among pig farmers in Malaysia.

Q : Should I be worried ?

A : A little. As it is transmitted from person to person and there is no effective antiviral therapy for this infection .

Q : Who is at high risk ? How is it transmitted ?

A : 1. People working with pigs and consuming pigs.

2. Farmers who come in contact with bats.

3. Consuming Fruits-which are already bitten by bat.

4. Contact with people who already have Nipah virus infection.

Q : What are the early symptoms ?

Geethanjali College of Engg. Tech.
Cherayal (V), Keerasara (M), R.R. Dist. (A.P.)-501 301

PRINCIPAL



J-HUB: ENLITE VENTURE VOYAGER 2018

TEAM NO:

DATE OF SUBMISSION:

TEAM :

TEAM EMAIL:

IDEA GENERATION SCORE:

WORKSHEET- 2B

MARKET SURVEY & CHECKLIST

QUESTIONNAIRE

PROBLEM STATEMENT: write your assumption of a problem here.

PERSONAL PARTICULARS

- 1.NAME
2. ADDRESS
3. AGE
4. EMAIL
- 5.PHONE

PROBLEM VALIDATION QUESTIONNAIRE:

1. DO YOU FACE THE PROBLEM OF
YES NO
2. IF NO WHAT OTHER PROBLEM KEEPS YOU AWAKE AT NIGHT?
3. IF YES, WHO FACES THIS PROBLEM
4. IF YES WHEN DO YOU FACE THIS PROBLEM(FREQUENCY)
MOST FREQUENT (3TIMES A WEEK/DAILY)
MORE FREQUENT (ONCE A MONTH)
LESS FREQUENT (ONCE IN 3 MONTHS)
5. CURRENTLY WHAT SOLUTIONS YOU USE TO SOLVE THE PROBLEM.
6. WHAT DO YOU THINK WOULD BE A GREAT SOLUTION TO THIS PROBLEM?
7. WHAT PRICE POINT WOULD YOU BE WILLING TO PAY FOR SUCH A SOLUTION.

Format of one-page report:

1. Problem introduction-10 lines

CONTACT DETAILS:

PRINCIPAL
Geethanjali College of Engg. Tech.
Cheerlathur (V), Keesara (M), R.R. Dist. (A.P.) - 501 344



J-HUB: ENLITE VENTURE VOYAGER 2018

TEAM NO:

DATE OF SUBMISSION:

TEAM :

TEAM EMAIL:

PRE-GAME WORKSHEET NO: 0

MATERIALS TO BE SENT ON 22ND MAY 2018

1. 5 M QUIZ
2. SCORE SHEET
3. RESULTS
4. WHO AM I
5. SWS-0

Place a sticker on your shirt- saying your style & team no:

SUBMISSION WORKSHEET -0

COLLEGE NAME

MY TEAM NAME

MY EMAIL

MY MOBILE CONTACT-

MY TEAM MATES

1.

2.

3.

OUR TEAM COMBINATION

NAME OF MEMBER -

STYLE

OFFICE USE ONLY

TEAM COMBINATION SCORE:

CONTACT DETAILS:

PRINCIPAL
Geethanjali College of Engg. Tech.
Chennai (P), Kasiyero (M), R. R. Dist. (A. P.) - 501 304



- Roomsketcher
- IKEA
- GodrejInterio

PLANNER 5d

- Planner 5D is a simple-to-use app that enables anyone to create beautiful and realistic interior and exterior designs in 2D and 3D modes.
- You can choose interior and exterior items from a comprehensive catalog in order to plan and furnish your home or any other space the way you have always wanted, and you can see what everything looks like in reality using the Virtual Reality mode.
- 10,000,000+ downloads on Google Play
- 12,000,000+ interior and exterior designs created by our users
- 16,000,000+ Planner 5D users worldwide
- 1,000,000+ snapshots made
- Its rating is 4.3/5 in google play.
- Reference->(<https://play.google.com/store/apps/details?id=com.planner5d.planner5d&hl=en>)
- Planner 5d generates \$12.3k in revenue(owlers.com)

ROOMSKETCHER

- RoomSketcher competes in the renovation and interior design service field.
- In RoomSketcher customers can create their floor plans, home designs and office projects online.
- It allows the customers to draw or order from their floor plan services.
- Its an interactive floor plan that allows the customer to edit online.
- Its rating is 2.9/5 in google play.
- It has 100 thousand downloads in google play.
- Reference->(<https://www.roomsketcher.com>)
- It generates \$8M in revenue(owlers.com).

IKEA

- IKEA is global player in furniture industry and have good presence in india with outlets in major cities.
- IKEA has been present in India for last 30 years .It currently has 48 suppliers.
- It supports innovation and entrepreneurship and invests in modern manufacturing technology.(www.IKEA.com).
- The main financial principle of the IKEA is to grow by using our own resources.
- They re-invest a majority of their profits in existing and new IKEA stores, well as in product development.
- They provide quality at low price.

GODREJINTERIO

Principal
Gautam College of Engg. Tech.
Gadagol (V), Anasara (H), B.R. Dist. (A.P.)-501 022

HEXD.

Strengths

- The proven ability to establish excellent personalized client service.
- Strong relationships with suppliers that offer flexibility and respond to special product requirements.
- Good referral relationships with architects, complementary vendors, and local realtors.

Weaknesses

- Not established in a market where a variety of interior design options exist.
- Challenges of the seasonality of the business.

Opportunities

- A significant portion of our target market is desperately looking for the services Hexd will offer.
- Promising activity from new home construction activity.
- Changes in design trends can initiate home updating and, therefore, generate sales.

Threats

- Continued price pressure due to competition or the weakening market reducing contribution margins.
- Dramatic changes in design, including fabric colors and styles can present challenges to keep paced with what is desired by what is expected to be a leading-edge client base.
- Expansion of products and services offered by other sources .

->This analysis indicates solid potential success, but the weaknesses and threats must be recognized throughout the life of the venture

Positioning

- For the person that seeks to create a personalized and unique impression of her home, HEXD is the source for them.
- Clients will be impressed with services they received and outcome they have enjoyed.
- Unlike the other apps HEXD allows the customers/clients to design and furnish the interior and exterior of their house and provides a facility to buy the products online with quality certification.

Differentiation

- Chatbots to help customers in every aspect.
- Giving the possibility to buy electronic goods and furniture at a relatively lower price.
- Giving a special package of 50% offer - If the customer subscribes for this

PRINCIPAL
Geethanjali Chinnappa, B.Tech.
(P), Raasara (M), R.R. Dist. (A.P.) - 501 301

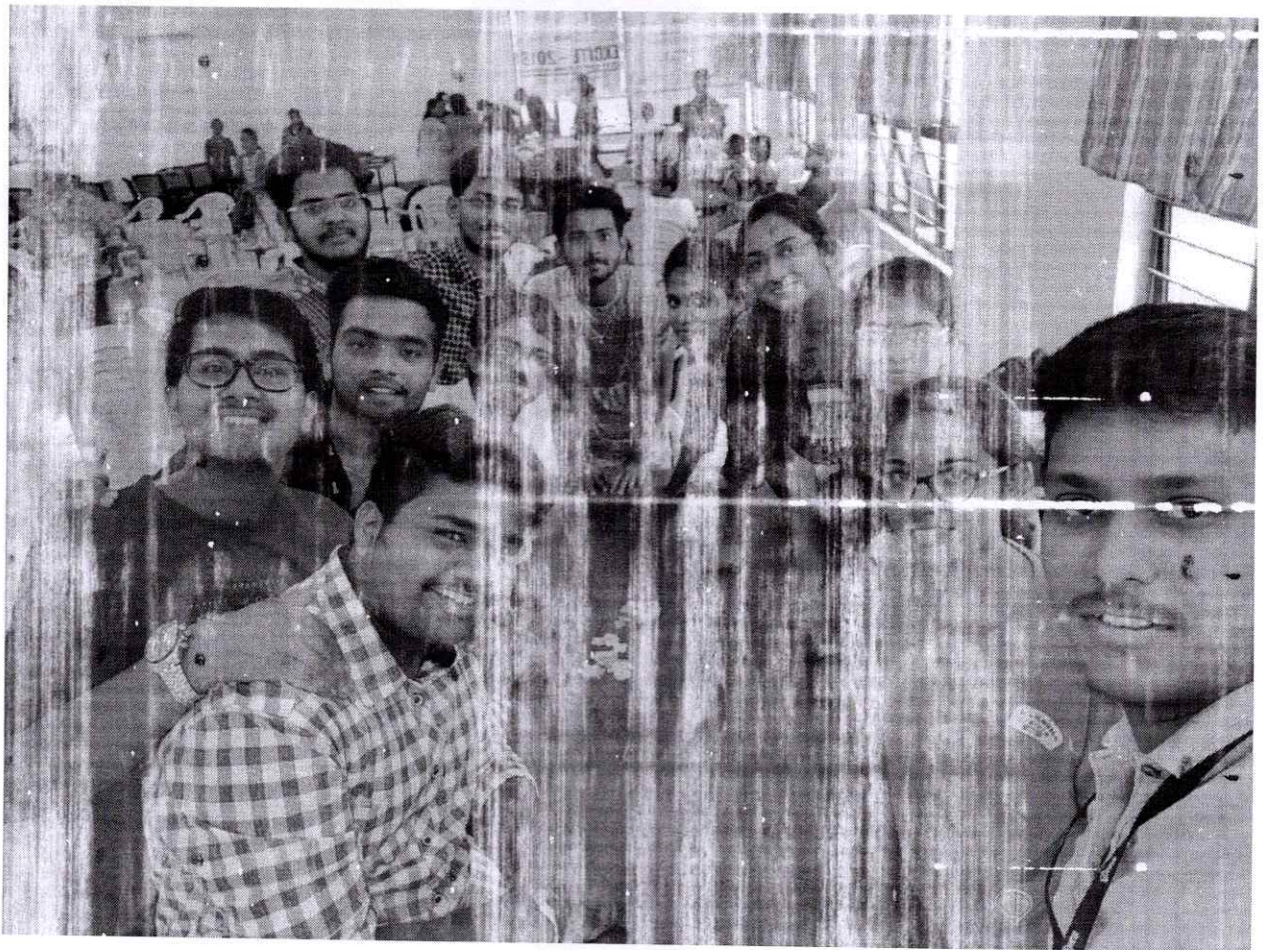
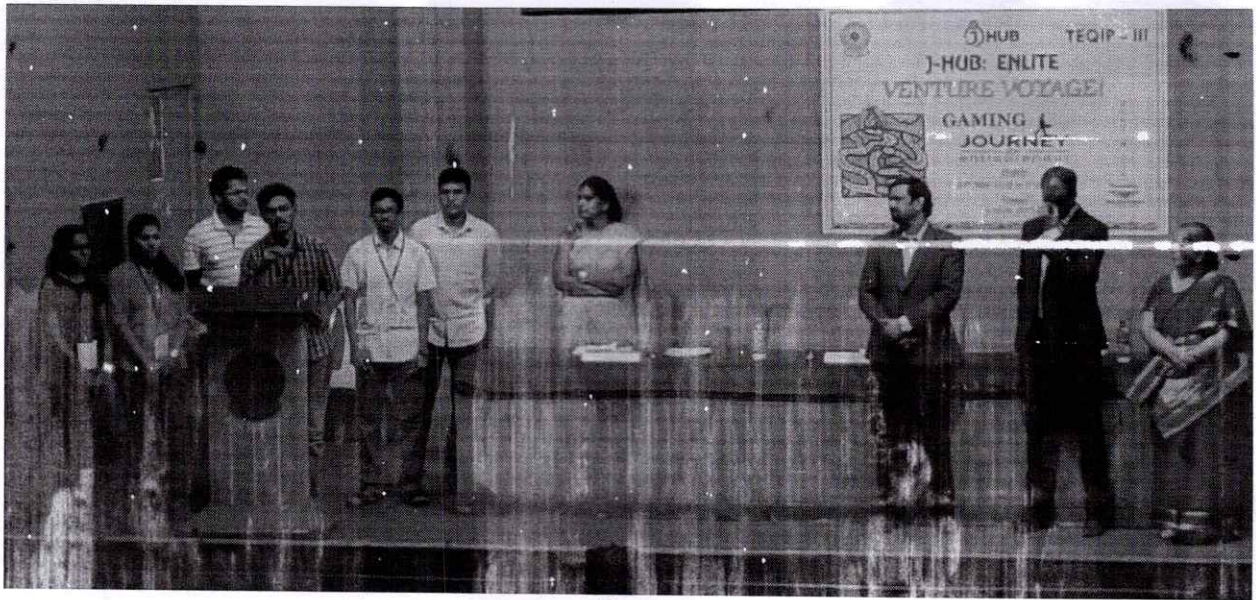

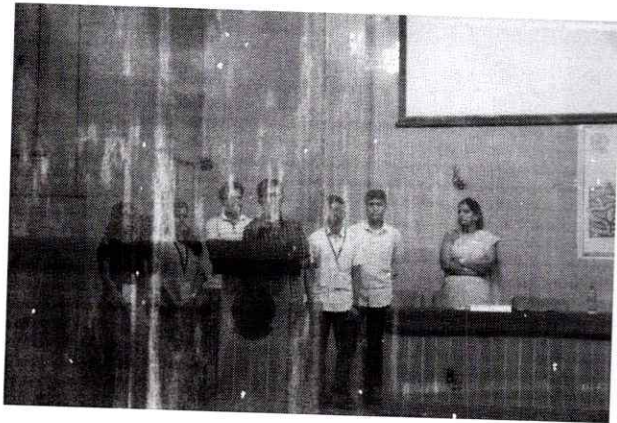

PRINCIPAL
Geethanjali College of Engg. Tech.
Cheeryal (V), Keesara (M), R.R. Dist. (A.P.) - 501 301

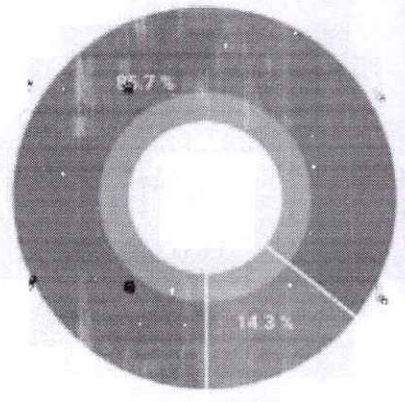

PRINCIPAL
Geethanjali College of Engg. Tech.
Cheeryal (V), Keesara (M), R.R. Dist. (A.P.) - 501 301

1) Do you ever face the problem in designing your house interior and exterior?



Yes [6] No [1]

2) Do you even feel that you were selected products went wrong from your imagination as a reality?

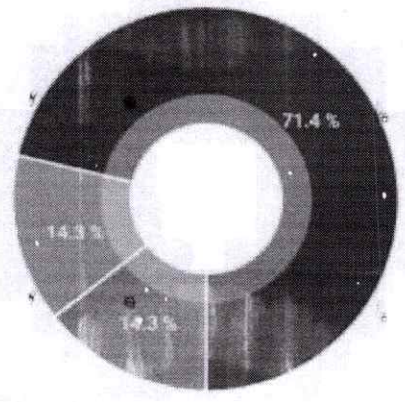

Yes [5] No [1] Maybe [1]

3) Do you really find the furniture which suits your interior design?

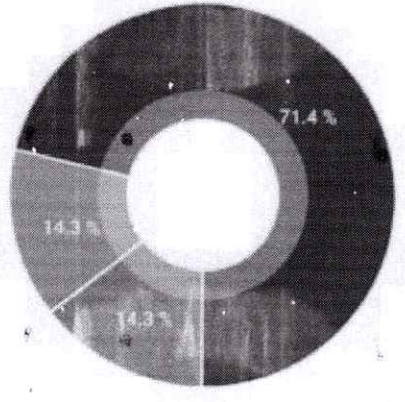

Very dissatisfied [1] Neither satisfied nor dissatisfied [1] Satisfied [5]

Geethanjali College of Engg. Tech.
 Cheeryal (V), Keesara (M), R.R. Dist. (A.P.) - 501 301



J-HUB: ENLITE VENTURE VOYAGER 2018

TEAM NO:

DATE OF SUBMISSION:

TEAM :

TEAM EMAIL:

S.No	MySolution features	benefits	Possible challenges	Differentiation/changes to make/remarks
01				
02				
03				
04				
05				
06				

5. Identify the current solution(My Product) weaknesses. (e.g. costly, time, design, not compatible)-why they will not buy my product?
Recognise the setbacks or risks or problems in building the product. minimum three

S.No	Reasons not to buy	Risk/problem	notes
01			
02			
03			
04			
05			
06			

6. RECOGNISE THE DIFFRENTIATORS AND WRITE THE VALUE THEY PROVIDE.

1.
2
3
4
5

7. OUR PRODUCT VERSUS TOP TWO COMPETITION- A 5 FEATURES COMPARISON.

FEATURES	Compet-1	Compet-2	Our product	remarks

CONTACT DETAILS:

PRINCIPAL
Geethanjali College of Engg. Tech.
Cheeryal (V), Keesara (M), R.R. Dist. (A.P) - 501 301



J-HUB: ENLITE VENTURE VOYAGER 2018

TEAM NO:

DATE OF SUBMISSION:

TEAM :

TEAM EMAIL:

WORKSHEET- 5 COMPETITION ANALYSIS

1. For the problem identified describe what solutions does the customer profilers CURRENTLY use?
2. Describe any five top currently used solutions for the identified problem & describe their unique features.

S.No	Solution name/competition	Features	Remarks
01			
02			
03			
04			
05			
06			

3. What is the price range they pay for these solutions?

S.No	Solution name/competition	Price	Remarks
01			
02			
03			
04			
05			
06			

4. Evaluate the current solution (My Product) designed by you..
(e.g costly, aesthetic, short, economical, value for consideration but low on satisfaction or has a host of other points)

CONTACT DETAILS:

Geethanjali G...
Gowryal (V), Kousara (M), R.R. Dist. (A.P.) - 501 387



EXECUTIVE SUMMARY

- Hexd house interior and exterior design platform that will offer comprehensive interior and exteriors design services for homes and offices.
- Hexd is a simple app that enables anyone to create realistic interior and exterior designs.
- Hexd allows the customers to choose the items from a comprehensive catalog in order to plan and furnish their house and they can see what everything looks like in reality using the virtual reality mode.
- Hexd also allows the customers to buy the furniture, paints, electronic goods that best suits their house.
- This app offers the personalized services and target market desires and can afford in a way that is unique from concept to implementation.
- Recent market research indicates a specific and growing need in the area for interior and exterior design consulting services and products hexd interiors and exteriors offers the market it will serve.
- The approach to promote Hexd will be through establishing relationships with key people in the community.
- Hexd focuses on offering design solutions based on the clients taste, budget, use, and goals for the space.
- The additional selection, accessibility of product, design differentiate hexd from the other options.

MARKETING PLAN

- Hexd deals with various companies like paints companies, architectures, furniture companies etc and takes share from every company for making deal with client.
- Hexd is basically an app or a website. Free downloading of app and free registration, more number of designs, offers help us in establishing the image and identity of our brand.
- Among different segments like residential, commercial, corporate, Hexd works only on residential segments, where houses receive the hexd services.
- Hexd designs in markets are subdivided based on tastes and preferences of people.
- People of different genders can find the best designs. Sub-segments are based on gender, age group, income.
- Hexd services can be accessed by people through advertisements in Tv and the other sources like newspapers.
- Market access for goods are easily available
- Few of hexd goods are imported from other countries with the government permission.
- Hexd targets the middle class people who find difficulties in affording higher

PRINCIPAL
Geethanjali College of Engg. Tech.
Keesara (M), R.R. Dist. (A.P.) - 501 301

points discussed :-

1. Since all the innovative projects are nearing to completion it is decided to conduct a hackathon in the college premises on 20.01.18
2. Campaigning would be conducted in & around college of Hyderabad
3. Guest of honor would be Dr. G. Vijaya Kumari (Director - JHUB) and Dr. N. Venkatesh Redpine signals
4. We have so far decided that the hackathon consists of two activities 1. Idea presentation 2. Project presentation
5. The idea presentation only for 1st yr students of geet and project presentation open for all
6. so far we have received 10 innovative projects from various Engg colleges
7. Logistics - Harish sir (EEE), J. Uma Mahesh (ECE)
Room allotments - N. Chandrakanth, Y.V.N. Phanikishore

Prof. N. Chandrakanth. 

Dr. Harish Pillori
Y.V.N. Phanikishore



O.V.R. Sivakumar



Preeti Phasala



PRINCIPAL
Geethanjali College of Engg. Tech.
Cheerthi (V. Koteswara (M), R.R. Dist. (A.P.) - 501 301.

Agenda:-

Merging of EDC, New, Incubation Activities under JHUB

Points Discussed:-

- 1) As per the directions of principal sir and subsequent meetings with JHUB Direction (Dr. G. Vijaya Kumar) it is advised to merge all the activities which are to be conducted in the college will now be a part of JHUB.
- 2) EDC and NEN Activities will be coordinated by Preeti Prasad of C&E
- 3) Identify teams from each department and constitute meetings with students for innovation/incubation activities.
- 4) Each faculty member will be allocated one team they would be guiding the students with respective projects
- 5) Planned to conduct workshop on Arduino & Raspberry Pi

Prof. N. Chandrababu
 Y. V. Phani Kishan -
 Chakravarthy

Dr. Harish Pulloji

Preeti Prasad



PRINCIPAL
 Geethanjali College of Engg. Tech.
 Cheerai (V), Keesara (M), R.R. Dist. (A.P.) - 501 301.

JHUB/EDC/

14/9/17

M O M
I-Cell (GCET).

Points Discussed

List of Activities conducted for the AY. - 2016-17.

Project Prototypes to be showcased in various college level competitions

prototype presentations to be submitted by the students on or before 21/9/17.

Prof. N. Chandrakanta - [Signature] Dep. Head - [Signature]
Prof. V. R. Sivakumar [Signature] 14/9/17

Proect Prasada - [Signature]

Y. Rajesh Kumar - [Signature] 14/09/17

Y. Phani Kishore - [Signature] 14/9

Dr. A. Sita Madhavi - [Signature] 14 sept 17

K. Venkatesh - [Signature] 14/9/17





[Signature]
PRINCIPAL
Geethanjali College of Engg. Techn.
Cheerla (V), Keesara (M), R.R. Dist. (A.P.) - 501 301

Agenda:

constitution of incubation cell (I-cell) - JHUB committee

Points Discussed

1. Institute has signed up with JNTU Innovation Hub (JHUB) for conducting various innovations activities under JHUB in college.
2. As per principal sir direction we have to form a committee consisting of faculty members from various departments.
3. All the activities that we have done under I-cell (centre for innovation and creativity) will now be a part of JHUB.

1. Y.V.V. Phani (ishore) - Ther-
2. O.V.R. SIVA KUMAR All
3. B. Subb Rao (ME) 
4. K. NIRANJAN KUMAR 
5. DR. Harish Pilluri 
6. B.P.S. Jyothi 
7. Preeti Prasad/a 



PRINCIPAL
Geethanjali College of Engg. Tech.
Choeryl (V), Kosuru (M), R.R. Dist. (A.P.) - 501 506



Agenda:- EXCITE

Points:-

1. As per the recent meeting with IITOB Director, it is informed to all that IAWITE, BOOTCAMP & EXCITE would be tentatively held on March, April, 2018 for 1st, 2nd & 3rd yr students.
2. EXCITE is a 6 weeks summer product engineering workshop.
3. Boot camp is for 2nd year for gaining insights on entrepreneurship.
4. Ignite is for 1st year students for awareness on innovation and entrepreneurship.
5. All faculty are requested to nominate 3 students from their respective branches.
6. All the activities have to be published in S to magz & other social platforms.

A. Chandra Chandrakanth . N

G.V.P.R. Sivakumar

Dr. Harish Pullori

Preeti Prasada
y.v.v. Phani kishore

Pr

Pr

P. Preeti

Pr

PRINCIPAL
Geethanjali College of Engg. Tech.
Sriperumbudur (M), R.R. Dist. (A.P.) - 501 301

GEETHANJALI COLLEGE OF ENGINEERING AND TECHNOLOGY
Cheeryal (V), Keesara (M), Medchal Dist, T.S. - 501301

Date: 31/07/2017

To,

The Principal,

Geethanjali College of Engineering and Technology,

Cheeryal(V), Keesara (M), Medchal Dist, 501301

Respected Sir,

Sub: Request for conducting Android Application Development Workshop on 12th, 13th and 14th August 2017: Reg.

The "Centre for Creativity and Innovation" wants to organize a 3 day workshop on Android Application Development on 12th, 13th, and 14th August, 2017 in association with **Computer Society of India (CSI)** and **National Small Industries Corporation (NSIC)**.

We request you to kindly approve the above mentioned event.

Thanking you,

Your Sincerely,



Prof. N. Chandrakanth

Convener



Y.V.N. Phani Kishore

Co- convener.

Please Go ahead.

Stk
9/09/08/17



PRINCIPAL
Geethanjali College of Engg. Tech.
Cheeryal (V), Keesara (M), R.R. Dist. (A.P.) - 501 301

Cheeryal (V), Keesara (M), RR Dist - 501301

COLLEGE CANTEEN ITEM REQUEST FORM

Date: 9/8/17

Name: Y.V.N. Phani Kishore
Purpose: workshop

Design: Asst prof
Date Required: 12, 13, 14th Aug 2017
Dept: CSE

Meal: Spl..... Nrm 40 / Tiffins..... / Soft drinks..... Tea or coffee 80 / Snacks..... / Five star chocolates.....
10 - morning
10 - evening

Phani
Signature of requester

HOD
Recommended by
Prof. N. Chandrakanth

Approved / Not Approved
PRINCIPAL
Shr

To be filled at the time of serving the food:

Name of the Coordinator / In-charge..... Design & Dept.....
No. of items coinsured: Meals: Spl..... Nrm..... / tiffins..... / Soft drinks.....
Tea or Coffee..... / snacks..... / Five star chocolates.....

Signature of the Coordinator / In-charge

Verified by Recommended by Approved by

Geethanjali College of Engineering & Technology

Cheeryal (V), Keesara (M), RR Dist - 501301

PERMISSION SLIP FOR VEHICLE

Date: 9/8/17

Name of Indentor: Y.V.N. Phani Kishore Department: CSE

Designation: Asst prof

For use by: N. Chandrakanth Designation: prof

Purpose: workshop

Date on which required: 12, 13, 14, Aug 2017 From: Sec Tanaka

to: get get

Starting time: 8:30 Am Return time: 4:30 PM Approximate total KM:

College / Private Vehicle: college Type of vehicle: Bus (2 nos)

Whether private vehicle required: (if requested college vehicle not available) Yes / No

Phani
Indentor

HOD Prof. N. Chandrakanth

Whether college vehicle available: Yes/No

Transport I/C Signature

Approved college Private Vehicle

PRINCIPAL

PRINCIPAL



Geethanjali College of Engineering and Technology

CHEERYAL (V), KEESARA (M), R.R.DIST-501301, ANDHRAPRADESH

Department of Computer Science & Engineering

Date: 04/08/2017

Circular

Android Development Workshop

The students of II, III year are hereby informed that the Dept of CSE in association with the "Center of Creativity and Innovation" and "Computer Society of India (CSI)", will be conducting a Student Development Workshop on "Android App Development" on 12th, 13th and 14th August 2017 in the college. The prerequisites to this workshop are

1. The students should bring their own Laptops
2. The students should have prior knowledge of JAVA programming
3. Workshop will be conducted only for 30 students on first-come-first-serve basis.

The trainer will be coming from NSIC. The cost of the workshop is Rs. 1000.00 (Rs. One thousand only). A certificate of participation will be given to all participants.

Interested candidates may register themselves by paying the amount to Y.V.N. Phanikishore (9000208680) or Uma Mahesh (8374878521), Dept of CSE on or before 9th August 2017.

Thanks and Regards

Prof. N. Chandrakanth

Department of CSE

Geethanjali College of Engineering and Technology

II - A

II - B

II - C

II - D

II - E

III-A

III-B

III-C

III-D

IV-A

IV-B

IV-C

IV-D

PRINCIPAL

Geethanjali College of Engg. Tech.
Cheeryal (V), Keesara (M), R.R. Dist. (A.P.) - 501 301

DATE: 16/8/2017

To,
The Principal
GCET, Cheeryal

Through Proper Channel

Respected Sir,

The workshop on "Android Application Development" has been successfully conducted to the students of GCET on 12,13,14th of August 2017 (3 days). The following faculty have coordinated and attended the workshop during the days mentioned below. I request you to please approve Compensatory leave for the following faculty

3 Days CCLs (coordinated on all 3 days of Workshop)

1. Prof. N. Chandrakanth (CSE)

2 Days CCLs (Coordinated/attended on first 2 days of Workshop)

1. Y.V.N. Phani Kishore (CSE)
2. A. Hare Krishna (CSE)

Thanks and Regards



Prof. N. Chandrakanth
Dept of CSE.
GCET, Cheeryal

*As per
consideration
18/8/17*



PRINCIPAL
Geethanjali College of Engg. Tech.
Cheeryal (V), Keesara (M), R.R. Dist. (A.P.) - 501 301

DATE: 16/8/2017

To,
The Principal
GCET, Cheeryal

Through Proper Channel

Respected Sir,

The workshop on "Android Application Development" has been successfully conducted to the students of GCET on 12,13,14th of August 2017 (3 days). The following faculty have coordinated and attended the workshop during the days mentioned below. I request you to please approve Compensatory leave for the following faculty:

3 Days CCLs (coordinated on all 3 days of Workshop)

1. Prof. N. Chandrakanth (CSE)

2 Days CCLs (Coordinated/attended on first 2 days of Workshop)

1. Y.V.N. Phani Kishore (CSE)

2. A. Hare Krishna (CSE)

Thanks and Regards



Prof. N. Chandrakanth
Dept of CSE,
GCET, Cheeryal

*Approved for
consideration
18/8/17*



PRINCIPAL
Geethanjali College of Engineering & Technology
Cheeryal (V), Kousale (Tal), Khammam (Dist), Telangana

Cheeryal (V), Keesara (M), RR Dist - 501301

COLLEGE CANTEEN ITEM REQUEST FORM

Date: 9/8/17

Name: Y.V.V. Prani kishore
Purpose: workshop

Design: Asst prof Dept: CSE

Date Required: 12, 13, 14th Aug 2017

Meal: Spl..... Nrmal 40 / Tiffins..... / Soft drinks..... Tea or coffee 80 / Snacks..... / Five star chocolates.....
40 - morning
40 - evening

Signature of requester

HOD

Recommended by

Prof. N. Chandrababu

Approved / Not Approved

PRINCIPAL

To be filled at the time of serving the food:

Name of the Coordinator / In-charge....., Design & Dept.....
No. of items coinsured: Meals: Spl..... Nrmal..... / tiffins..... / Soft drinks..... /
Tea or Coffee..... / snacks..... / Five star chocolates.....

Signature of the Coordinator / In-charge

Verified by Recommended by

Approved by

Geethanjali College of Engineering & Technology

Cheeryal (V), Keesara (M), RR Dist - 501301

PERMISSION SLIP FOR VEHICLE

Date: 9/8/17

Name of Indentor: Y.V.V. Prani kishore Department: CSE

Designation: Asst prof

For use by: N. Chandrababu Designation: prof

Purpose: workshop

Date on which required: 12, 13, 14, Aug 2017 From: Sec Tannaka

to: get get

Starting time: 8:30 AM Return time: 4:30 PM Approximate total KM:

College / Private Vehicle: college Type of vehicle: Bus (2 nos)

Whether private vehicle required: (if requested college vehicle not available) Yes / No

Indentor

HOD Prof. N. Chandrababu

Whether college vehicle available:

Yes/No

Transport I/C Signature

Approved college Private Vehicle

PRINCIPAL

Geethanjali College of Engg. Tech.
Cheeryal (V), Keesara (M), R.R. Dist. (A.P.) - 501 301

PRINCIPAL

Received dd on 13/08/2017
 We will provide the receipt in a
 week or 10 days.

Dand
 (G. Dandga Prasad)

Key: YOCCUQ
 Sr. No: 746426

1	0	0	8	2	0	1	7
D	D	M	M	Y	Y	Y	Y

को या उनके आदेश पर जारी करें

बैंकर्स चेक
BANKERS CHEQUE

आर.डी. बैंक
 (Reserve Bank of India (RBI))
 कोड नं. / CODE No: 20435
 Tel No. 08418-285258

PAY NSICTSC
 Twenty Eight Thousand Eight Hundred Only

28800.00

रुपये RUPEES

₹

भारतीय स्टेट बैंक
 FOR STATE BANK OF INDIA

1010004604101380

Key: YOCCUQ Sr. No: 746426

AMOUNT BELOW 2000 (2/2)

Pen

शाखा प्रबंधक
 BRANCH MANAGER

प्रधिकृत हस्ताक्षरकर्ता
 AUTHORISED SIGNATORY

अव्यय / NOT TRANSFERABLE

₹ 1,50,000/- एवं अधिक के लिखत दो अधिकारियों द्वारा हस्ताक्षरित होने पर ही वैध है।
 INSTRUMENTS FOR ₹ 1,50,000/- & ABOVE ARE NOT VALID UNLESS SIGNED BY TWO OFFICERS

केवल 3 महीने के लिए वैध
 VALID FOR 3 MONTHS ONLY

कंप्यूटर द्वारा मुद्रित होने पर ही वैध
 VALID ONLY IF COMPUTER PRINTED

⑈ 101390⑈ 000002000⑈ 000484⑈ 15

PRINCIPAL
 Choeryal College of Engg. Tech
 Choeryal (V), Keesara (M), R.R. Dist.

GEETHANJALI COLLEGE OF ENGINEERING AND TECHNOLOGY

CHEERYAL(V),KEESARA(M),MEDCHAL TS 501301

WORKSHOP ATTENDANCE SHEET

DATE: 13/08/17

DEPARTMENT OF CSE

TOPIC: Android Application Development

S.NO	ROLL NO.	STUDENT NAME	Session 1	Session 2
1	15R11A0505	B. Vamsi	Vamsi	Vamsi
2	15R11A0508	D. Teja Sai Srinivas	Teja	Teja
3	15R11A0505	S. Pranith Reddy	Pranith	Pranith
4	15R11A0549	Y. Rudhvik	Rudhvik	Rudhvik
5	15R11A05F5	P. Sai Sai Ram	Sai Ram	Sai Ram
6	15R11A05L7	Lijya Rose Antony	Lijya Rose	Lijya Rose
7	15R11A0590	D. Sai Vishal	Vishal	Vishal
8	14R11A04M6	Ramanar Raju A	Raju	Raju
9	14R11A05K1	B. Balu Gayatri	Balu	Balu
10	14R11A05T6	G. Vineetha	Vineetha	Vineetha
11	14R11A05K4	G. Deepika	G. Deepika	G. Deepika
12	14R11A05L4	K. Sai Sai	Sai Sai	Sai Sai
13	16R11A0596	B. Manisha Reddy	Manisha Reddy	Manisha Reddy
14	16R11A05D1	Sathu-charan	S. Charan	S. Charan
15	16R11A05B9	N. ADITYA SAI SUMANTH	Sumanth	Sumanth
16	16R11A05H7	M. Nidhi	Nidhi	Nidhi
17	16R11A05G7	J. Raj Shekar	Raj Shekar	Raj Shekar
18	16R11A05CS	P. Vithan	Vithan	Vithan
19	15R11A05G6	sandhya Marya	Sandhya	Sandhya
20	15R11A05D5	E. shravani	E. shra	E. shra
21	16R11A05E2	V. P. Lalitha	Lalitha	Lalitha
22	15R11A05M0	M. Mounal Moses	Mounal	Mounal
23	15R11A05B4	Shaik. Saleem	Saleem	Saleem
24	15R11A0594	Sai Kumar	Sai Kumar	Sai Kumar
25	15R11A0593	Shanthan Kumar	Shanthan	Shanthan
26	15R11A0585	Vishwateja	Vishwateja	Vishwateja
27	15R11A05A4	Vamsi	Vamsi	Vamsi
28	15R11A0595	See kanth	See kanth	See kanth

PRINCIPAL

Geethanjali College of Engg. Tech,
Cheeryal (V), Keesara (M), R.R. Dist. (A.T.) 501301

Z

NSIC

राष्ट्रीय लघु उद्योग निगम लिमिटेड

The National Small Industries Corporation Ltd.

TSC

(A Government of India Enterprise)

Technical Services Centre,

Kamalanagar, ECIL Post, Kushaiguda, Hyderabad - 500 062.

BANK RECEIPT

Receipt No. BR/ 7254

To
M/S./Mr./Ms. M/s. Geethanjali
Engineering College,
Cheruvu Keesara

V.R. No.					
	DAY	MONTH	YEAR		
DATE	16	08	17		

(Handwritten mark)

PRINCIPAL

Geethanjali College of Engg. Tech.
Cheruvu (V), Keesara (M), R.R. Dist. (A.P.) - 501 301.

Received with thanks a sum of Rupees

Eight thousand only (5W 11)

Twenty Eight Thousand

by Cash / Cheque / D.D. No 101390

Drawn On SBI towards Andhraich-s/w-IT

Dt 10/08/2017

M, 24406 & Service Tax Payable Rs. 4399/-

Cheque (s) is / are subject to realisation

Rs. 28,800/-



ashier

Accounts Officer

(Handwritten signature)

Chief Manager (Accts)

For The NSIC LTD., TSC

8	2 week Boot Camp	J HUB JNTU
9	EXCITE 2K18	J HUB JNTU
10	J Hub Central Hackathon	JNTU JHUB
11	Hackathon 2 K 18	Redpine Signals
12	Geethanjali Cude Open	Deccan Cubing

Bhathi
Dept. of Computer Science & Engineering
Geethanjali College of Engineering & Technology
Cheeryal (V), Keesara (M), Medchal (Dist.)

[Green Arrow]
PRINCIPAL
Geethanjali College of Engg. Tech.
Cheeryal (V), Keesara (M), R.R. Dist. (A.P.) - 501 301

Date: 10/08/2017

To,
The Head of Department,
Department of Science and Humanities,
Geethanjali College of Engineering and Technology,
Cheeryal(V), Keesara (M), Medchal Dist.-T.S. 501301

Respected Sir,

Sub: Request for allocating AECS lab for android programming workshop-Reg.

The "Centre for Innovation and Creativity" is conducting a 3 day workshop on 12th, 13th and 14th August 2017. We request you to kindly permit us to conduct the workshop in AECS Lab (3rd floor, Block 1) for the above mentioned days.\

Thanking you,

Your Sincerely,



Y.V.N. Phani Kishore

Asst Prof,

Department of CSE,

Geethanjali College of Engineering and Technology

*Ok. kindly see that all equipment is in place.
Centre
10/08/2017*



PRINCIPAL
Geethanjali College of Engg. Tech.
Cheeryal (V), Keesara (M), R.R. Dist. (A.P.) - 501 301

Date: 10/08/2017

To,
The Accounts Officer,
Geethanjali College of Engineering and Technology,
Cheeryal(V),Keesara (M), Medchal Dist.-T.S. 501301

Respected Sir,

Sub: Procurement of Demand Draft for Android Workshop-Reg.

The "Centre for Innovation and Creativity" is conducting a 3 day workshop on 12th, 13th and 14th August 2017. As discussed with you yesterday, I request you to procure a Demand Draft in Favour of NSIC-TSC payable at Hyderabad for an amount of 28,800.00(Rupees Twenty Eight thousand and Eight hundred).

The details of the list of students are attached below for your reference.

Your Sincerely,

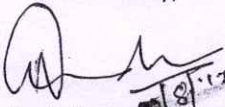

10/8/17
Prof. N. Chandrakanth
10/8/17
Convener

Y.V.N. Phani Kishore
Co-Convener

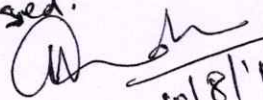
The amount has been collected from the students. I am herewith submitting Rs. 28,800/- to accounts for the above mentioned purpose. List of students is enclosed.

10/8/17
Prof. N. Chandrakanth
Dept. of CSE
GCET

PRINCIPAL
Geethanjali College of Engg. Tech.
Cheeryal (V), Keesara (M), P.R. Dist. (A.P.) - 501 301

TO
A/c

10/8/17

Registrations

Geethanjali College of Engg & Technology ANDROID WORKSHOP DEVELOPMENT

S.No	Roll No	Name	Branch	YeaR	Section	Amount
1	14R11A05K6	Garikipati Vineetha	CSE	4	D	800
2	15R11A05E7	M. Rahul Sai	CSE	3	C	800
3	15R11A05G5	SAIREDDY PRANITH REDDY	CSE	3	C	800
4	15R11A05A4	Polakonda sai vamshi	CSE	3	B	800
5	14R11A05L4	Katkam Sai Sri	CSE	4	D	800
6	15R11A0508	D TEJA SAI SRINIVAS	CSE	3	A	800
7	14R11A05K4	G Deepika	CSE	4	D	800
8	15R11A05Q0	Danturty Sai Vishal	CSE	3	D	800
9	15R11A05M0	Mrinal Moses Marshall	CSE	3	D	800
10	16R11A05B9	Nutikattu Aditya Sai Sumanth	CSE	2	C	800
11	15R11A05G6	Sandhya mourya	CSE	3	C	800
12	15R11A05H6	VALLALA SHIVA KUMAR YADAV	CSE	3	C	800
13	15r11a05f5	P. Sri Sai Ram	CSE	3	C	800
14	15R11A05F3	Nanganoori maheshkumar	CSE	3	C	800
15	16R11A05E2	Rahul Ramesh Vinjamor	CSE	2	C	800
16	16R11A05C5	Prerepa Vutham	CSE	2	C	800
17	15R11A0595	Mutyala Sreekanth reddy	CSE	3	B	800
18	15R11A0593	Shanthan-Kumar Mudumba	CSE	3	B	800
19	15R11A05B4	Shaik Saleem	CSE	3	B	800
20	15R11A0594	MUKKA SAI KUMAR	CSE	3	B	800
21	15R11A05H9	Yarlagadda Prudhvik	CSE	3	C	800
22	15R11A05D5	Ega shravani	CSE	3	C	800
23	15R11A0505	B VAMSHI	CSE	3	A	800
24	15R11A0550	E S S Manikanta Rohit	CSE	3	A	800
25	16R11A05B8	N.Rahul chowdary	CSE	2	C	800
26	14R11A05K1	Bugatha Bala Gayatri	CSE	4	D	800
27	16R11A05D1	Sadhu charan	CSE	2	C	800
28	16R11A05C1	MANISHA P	CSE	2	C	800
29	15R11A05I7	Liya Rose	CSE	3	D	800
30		g.sri sheetal	CSE	3	d	800
31	16R11A05H7	M. nidhi	CSE	2	D	800
32		K VISHWATEJA	CSE	3	D	800
33	16R11A05G7	J RAJ SHEKAR	CSE	2	D	800
34		M VINEETHA	CSE	3	A	800
35	16R11A0596	B. Manisha Reddy	CSE	2	B	800
36		Pranav Raj	ECE	4		800
					Total	28800

PRINCIPAL
Geethanjali College of Engg. Tech.
Cheeruvu (V), Keesara (M), R.R. Dist. (A.P.) - 501 308

S/K
9/10/18

Date: 10/08/2017

To,
The Accounts Officer,
Geethanjali College of Engineering and Technology,
Cheeryal(V), Keesara (M), Medchal Dist.-T.S. 501301

Respected Sir,

Sub: Procurement of Demand Draft for Android Workshop-Reg.

The "Centre for Innovation and Creativity" is conducting a 3 day workshop on 12th, 13th and 14th August 2017. As discussed with you yesterday, I request you to procure a Demand Draft in Favour of NSIC-TSC payable at Hyderabad for an amount of 28,800.00 (Rupees Twenty Eight thousand and Eight hundred).

The details of the list of students are attached below for your reference.

Your Sincerely,

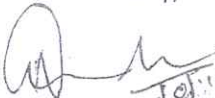

10/8/17
Prof. N. Chandrakanth
10/8/17
Convener

Y.V.N. Phani Kishore
Co-Convener

The amount has been collected from the students. I am herewith submitting Rs. 28,800/- to accounts for the above mentioned purpose. List of students is enclosed.

10/8/17
Prof. N. Chandrakanth
In-charge CSE

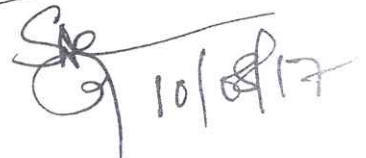
PRINCIPAL
Geethanjali College of Engg. Tech.
Cheeryal (V), Keesara (M), R.R. Medchal Dist. - T.S. 501301
AFC

10/8/17

Geethanjali College of Engineering and Technology

AUTONOMOUS

(Approved by AICTE, New Delhi, Permanently Affiliated to JNTUH Hyderabad)
Cheerlaji, Keesara(M), Medchal Dist. Ph : 9014241618, 9533791618

No. 1077

RECEIPT

Date: 10/08/2017

Received with thanks from Prof. N. Chandrakanthu (SE)
a sum of Rs. 28,800/- in words (Rupees Twenty eight Thousand
Eight hundred only)

_____ by Cash / Cheque No. _____

towards Paid for Android development work shop

For Geethanjali College of Engg. & Tech.

Authorized Signatory

PRINCIPAL

Geethanjali College of Engg. Tech.
Cheerlaji (V), Keesara (N), R.R. Dist. (A.P.) - 501 301

Date: 10/08/2017

To,
The Head of Department,
Department of Science and Humanities,
Geethanjali College of Engineering and Technology,
Cheeryal(V),Keesara (M), Medchal Dist.-T.S. 501301

Respected Sir,

Sub: Request for allocating AECS lab for android programming workshop-Reg.

The "Centre for Innovation and Creativity" is conducting a 3 day workshop on 12th, 13th and 14th August 2017. We request you to kindly permit us to conduct the workshop in AECS Lab (3rd floor, Block 1) for the above mentioned days.\

Thanking you,

Your Sincerely,



Y.V.N. Phani Kishore

Asst Prof,

Department of CSE,

Geethanjali College of Engineering and Technology

*OK. kindly see that all equipment
place.*

*Chandra
10/08/2017*

PRINCIPAL
Geethanjali College of Engg. Tech.
Cheeryal (V), Keesara (M), R.R. Dist. (A.P.) - 501301

Date: 10/08/2017

To,
The Head of Department,
Department of Science and Humanities,
Geethanjali College of Engineering and Technology,
Cheeryal(V), Keesara (M), Medchal Dist.-T.S. 501301

Respected Sir,

Sub: Request for allocating AECS lab for android programming workshop-Reg..

The "Centre for Innovation and Creativity" is conducting a 3 day workshop on 12th, 13th and 14th August 2017. We request you to kindly permit us to conduct the workshop in AECS Lab (3rd floor, Block 1) for the above mentioned days.

Thanking you,

Your Sincerely,



Y.V.N. Phani Kishore

Asst Prof,

Department of CSE,

Geethanjali College of Engineering and Technology

*OK. kindly see that all equipment
place.
Center
10/08/2017*



PRINCIPAL
Geethanjali College of Engg. Tech.
Cheeryal (V), Keesara (M), R.R. Dist. (A.P.) - 501 301.

Date: 10/08/2017

To,
The Head of Department,
Department of Science and Humanities,
Geethanjali College of Engineering and Technology,
Cheeryal(V), Keesara (M), Medchal Dist.-T.S. 501301

Respected Sir,

Sub: Request for allocating AECS lab for android programming workshop-Reg.

The "Centre for innovation and Creativity" is conducting a 3 day workshop on 12th, 13th and 14th August 2017. We request you to kindly permit us to conduct the workshop in AECS Lab (3rd floor, Block 1) for the above mentioned days.)

Thanking you,

Your Sincerely,



Y.V.N. Phani Kishore

Asst Prof,

Department of CSE,

Geethanjali College of Engineering and Technology

*OK. kindly see that all equipment in place.
Centre
10/08/2017*

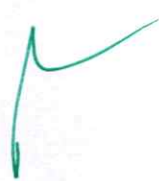

PRINCIPAL
Geethanjali College of Engg. Tech.
Cheeryal (V), Keesara (M), K.R. Dist. (A.P.) - 501301

GEETHANJALI COLLEGE OF ENGINEERING AND TECHNOLOGY

CHEERYAL(V),KEESARA(M),MEDCHAL TS 501301

WORKSHOP ATTENDANCE SHEET

DATE: 12/08/17

DEPARTMENT OF CSE

TOPIC: Android Application Development

S.NO	ROLL NO.	STUDENT NAME	Session 1	Session 2
1	14R11A05K1	B. Bala Gayathri	B4	B4
2	14R11A05K6	G. Vinodha	B4	B4
3	15R11A0517	Liya Rae Antony	Liya Rae	Liya Rae
4	15R11A0520	Danturty Sai Vishal	Vishal	Vishal
5	15R11A05M0	M. Marinal Moses	Moses	Moses
6	15R11A05K6	G. Sri Sheetal	Sheetal	Sheetal
7	14R11A04M6	Pranav Raju A	Pranav	Pranav
8	16R11A05H7	M. Nidhi	Nidhi	
9	16R11A05G7	J. Raj Shekhar	Raj	Raj
10	15R11A05G6	Sandhya Mowriya	S11	S11
11	15R11A05D5	E. Shrawari	E. Shrawari	E. Shrawari
12	15R11A05G5	S. Pranith Reddy	Pranith	Pranith
13	15R11A05E5	P. Sai Sai Ram	Sai Ram	Sai Ram
14	15R11A0595	M. Sreekanth	Sreekanth	Sreekanth
15	15R11A0593	M. Chanthan	Chanthan	Chanthan
16	15R11A0585	K. Vishwateja	Vishwateja	Vishwateja
17	15R11A05A4	P. Sai Varoshi	Varoshi	Varoshi
18	15R11A0594	M. Sai Kumar	Sai Kumar	Sai Kumar
19	15R11A05B4	Shah. Saleem	Saleem	Saleem
20	15R11A05H9	Y. Rudhvik	Rudhvik	Rudhvik
21	15R11A05E7	M. Rahul Sai	M. Rahul Sai	M. Rahul Sai
22	15R11A05H6	V. Shiva Kumar	Shivabhar	Shivabhar
23	15R11A05F3	N. Mahesh	Mahesh	Mahesh
24	16R11A05E2	V. R. Rahul	V. R. Rahul	V. R. Rahul
25	16R11A05B9	N. ADITYA SAI SUMANTH	Aditya	Aditya
26	16R11A05C1	P. Manishu	Manishu	Manishu
27	16R11A05D1	Sadhna Charan	Sadhna	Sadhna
28	16R11A05C5	P. Vithan	Vithan	Vithan

PRINCIPAL

Geethanjali College of Engg. Tech.
Cheeryal (V), Keesara (M), R.R. Dist. (A.P.) - 501 301.



Geethanjali College of Engineering and Technology

UGC Autonomous Institution

(Accredited by NAAC with 'A' grade, NBA, Approved by AICTE, Affiliated to JNTUH.)
Cheeryal(V), Keesara(M), Medchal(Dist.), Telangana - 501 301.



INNOVANT
TECHNOCRAT CLUB

PRINCIPAL

Geethanjali College of Engg. Tech.

Cheeryal (V), Keesara (M), Medchal (Dist.), A.P. - 501301

CERTIFICATE OF PARTICIPATION

This is to certify that Mr./Ms. Pravin Moses has participated in Three bearing roll number 15PI1A05110 Day Workshop on Android Application Development from 12th - 14th August 2017 Organized by Centre for Innovation and Creativity in Association with CSI and NSIC

Prof.N.Chandrakanth

Convener-GCET

G.Durga Prasad

Convener-NSIC

Dr.S.Udaya Kumar

Principal



Geethanjali College of Engineering and Technology

UGC Autonomous Institution

(Accredited by NAAC with 'A' grade, NBA, Approved by AICTE, Affiliated to JNTUH.)
Cheeryal(V), Keesara(M), Medchal(Dist.), Telangana - 501 301.

CERTIFICATE OF PARTICIPATION

This is to certify that Mr./Ms. m. shanthan kumar
bearing roll number 15211A0593 has participated in Three
Day Workshop on Android Application Development from
12th - 14th August 2017 Organized by Centre for Innovation and
Creativity in Association with CSI and NSIC

Prof.N.Chandrakanth

Convener-GCET

G.Durga Prasad

Convener-NSIC

Dr.S.Udaya Kumar

Principal



Geethanjali College of Engineering and Technology

UGC Autonomous Institution

(Accredited by NAAC with 'A' grade, NBA, Approved by AICTE, Affiliated to JNTUH.)
Cheeryal(V), Keesara(M), Medchal(Dist.), Telangana - 501 301.



INNOVANT
TECHNOCRAT CLUB

CERTIFICATE OF PARTICIPATION

This is to certify that Mr./Ms. DR SA VISHAL has participated in Three
Day Workshop on Android Application Development from
12th - 14th August 2017 Organized by Centre for Innovation and
Creativity in Association with CSI and NSIC

PRINCIPAL
Geethanjali College of Engg. Tech.
Cheeryal (V), Keesara (M), R.R. Dist. (A.P.) 501301

Prof.N.Chandrakanth

Convener-GCET

G.Durga Prasad

Convener-NSIC

Dr.S.Udaya Kumar

Principal

NSIC
A Three Day Workshop on
ANDROID APPLICATION DEVELOPMENT

Jointly Organized by
Centre for Innovation and Creativity
in association with
Computer Society of India

and
National Small Industries Corporation
Growthpoint College of Engineering and Technology

COE/NSIC/NSIC/2017/01
Centre for Innovation and Creativity
National Small Industries Corporation
Growthpoint College of Engineering and Technology
Growthpoint, K. Dhatu, Dist. (A.P.) - 501 304



PRESENT

A Three Day Workshop
on

ANDROID APPLICATION DEVELOPMENT

Jointly Organized by
Centre for Innovation and Creativity
in association with

Computer Society of India
Chapter

Geethanjali College of Engineering and Technology

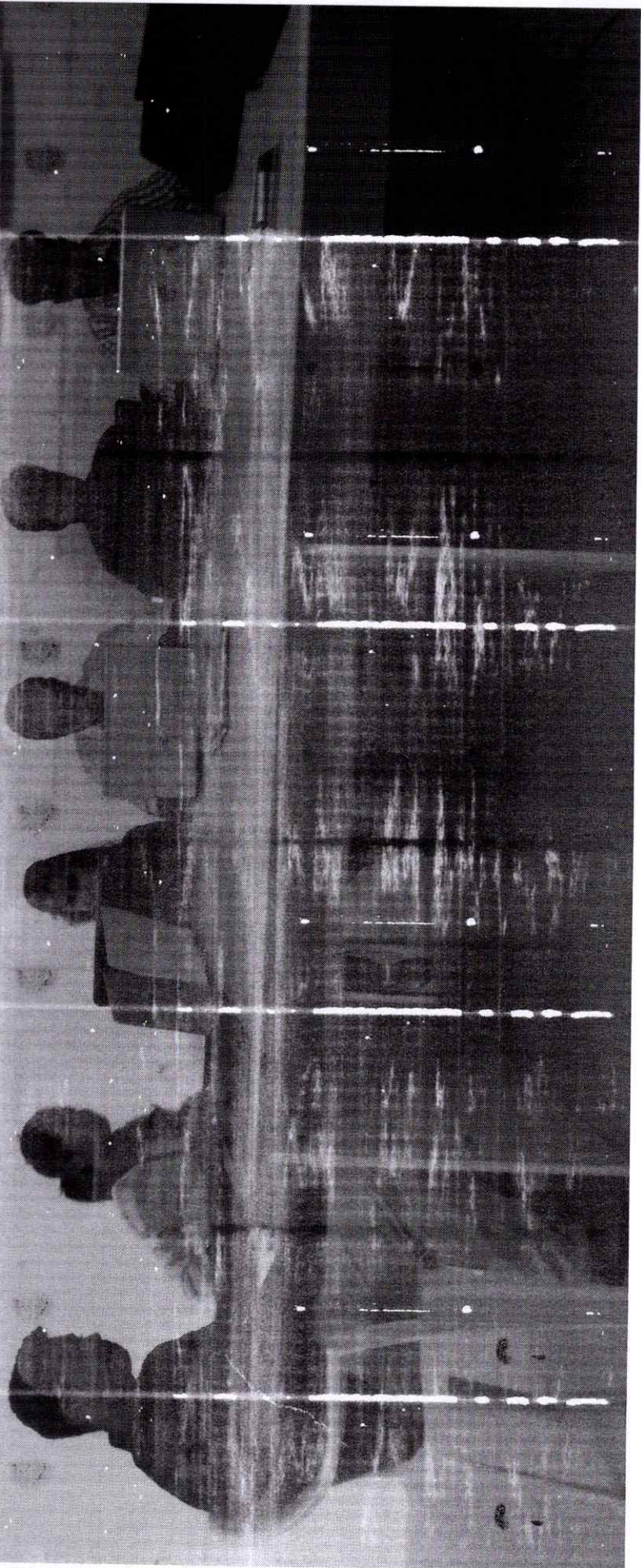

PRINCIPAL
Geethanjali College of Engg. Tech.
Cheeryal (V), Keesara (M), R.R. Dist. (A.P.) - 501 301

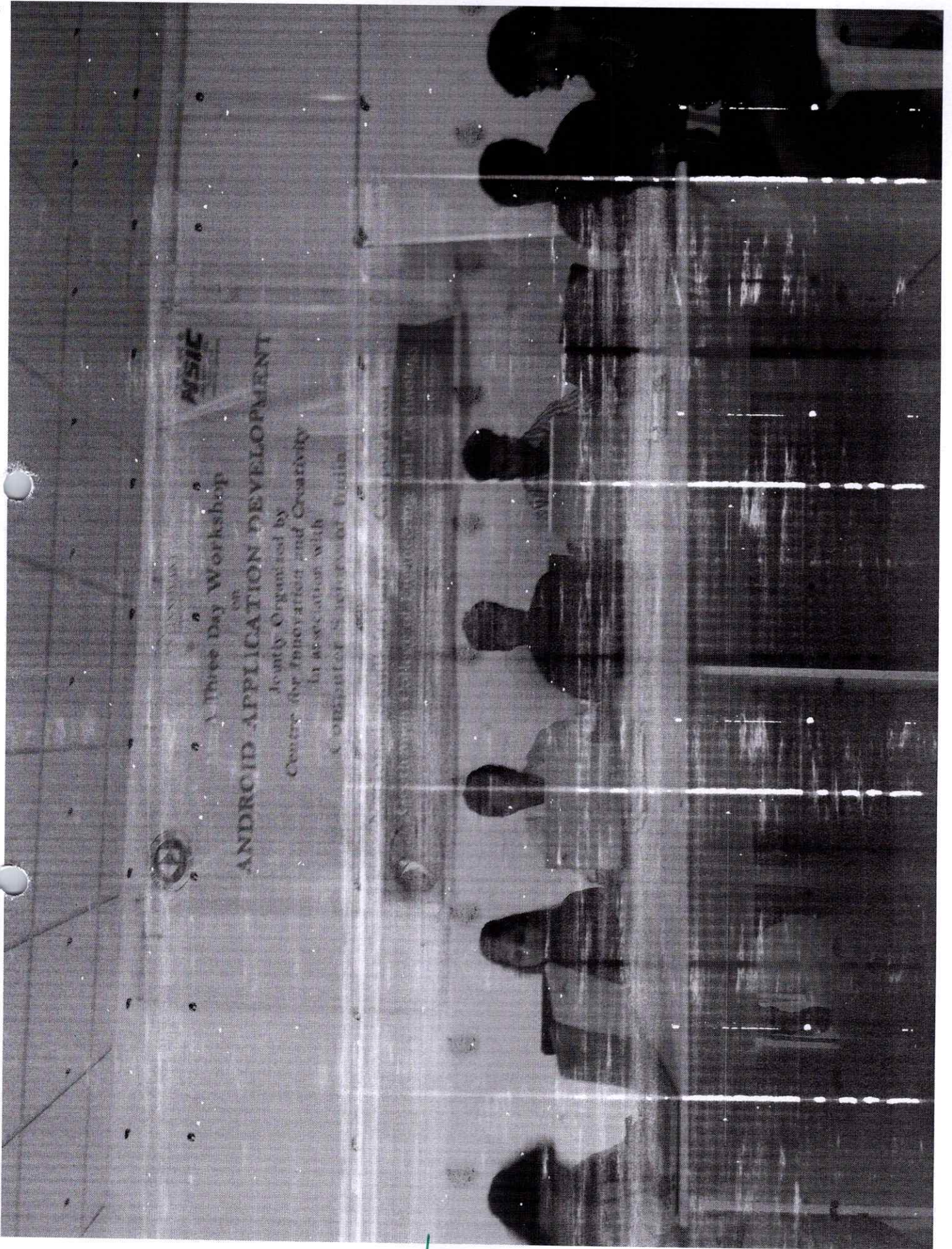

PISC

A Three Day Workshop

on ANDROID APPLICATION DEVELOPMENT

Jointly Organized by
Centre for Innovation and Creativity
in association with

Computer Society of India

PRINCIPAL
Geethanjali College of Engg. Tech.
Cheerla (V), Kavara (M), R.R. Dist. (A.P.)



A Three Day Workshop
ON
ANDROID APPLICATION DEVELOPMENT
 Jointly Organized by
Centre for Innovation and Creativity
 in association with

Computer Society of India
 National Small Industries Corporation
 Geethanjali College of Engineering and Technology

PRINCIPAL
 Geethanjali College of Engg. Techn.
 Choerrol (Y), Kaveri (M), R.R. Dist. (A.P.) - 501 202

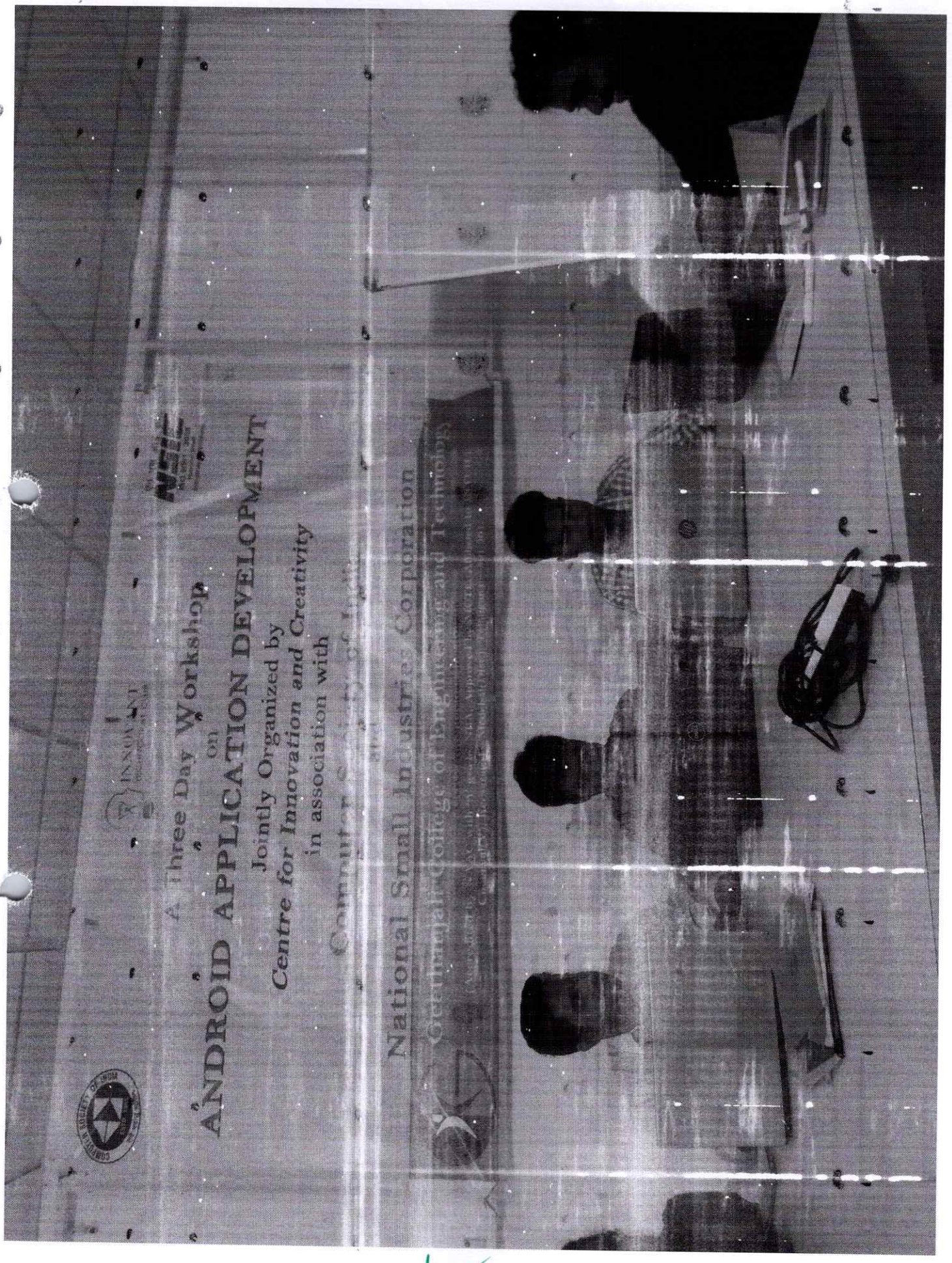

GEETHANJALI COLLEGE OF ENGINEERING AND TECHNOLOGY

CHEERYAL(V),KEESARA(M),MEDCHAL TS 501301

WORKSHOP ATTENDANCE SHEET

DATE: 14/08/17

DEPARTMENT OF CSE

TOPIC: Android Application Development

S.NO	ROLL NO.	STUDENT NAME	Session 1	Session 2
1	15R11A05D5	E. shravani	E. shra <i>ni</i>	E. shra <i>ni</i>
2	15R11A05G6	Sandhya Mounya	<i>Sandhya</i>	<i>Sandhya</i>
3	14R11A05L4	K. Sai Sri	<i>Sai Sri</i>	<i>Sai Sri</i>
4	14R11A05K4	G. Deepika	G. Deepika	G. Deepika
5	14R11A05K6	G. Vineetha	G. Vineetha	G. Vineetha
6	14R11A05K1	B. Gayatri	<i>B. Gayatri</i>	<i>B. Gayatri</i>
7	16R11A05B9	N. Aditya Sumanth	<i>N. Aditya Sumanth</i>	<i>N. Aditya Sumanth</i>
8	16R11A05H7	M. Nidhi	<i>M. Nidhi</i>	<i>M. Nidhi</i>
9	16R11A05G7	T. Rajasekhara	<i>T. Rajasekhara</i>	<i>T. Rajasekhara</i>
10	16R11A05D1	Sadhu. charan	<i>Sadhu. charan</i>	<i>Sadhu. charan</i>
11	15R11A05HA	Y. Prudhvik	<i>Y. Prudhvik</i>	<i>Y. Prudhvik</i>
12	15R11A05MO	M. Mouval Moses	<i>M. Mouval Moses</i>	<i>M. Mouval Moses</i>
13	15R11A05F5	P. Sai Sai Ram	<i>P. Sai Sai Ram</i>	<i>P. Sai Sai Ram</i>
14	15R11A05O8	D. Teja Sai Srinivas	<i>D. Teja Sai Srinivas</i>	<i>D. Teja Sai Srinivas</i>
15	15R11A05O5	B. Vamsi	<i>B. Vamsi</i>	<i>B. Vamsi</i>
16	15R11A05A4	P. Vamsi	<i>P. Vamsi</i>	<i>P. Vamsi</i>
17	15R11A0595	Sreekanth	<i>Sreekanth</i>	<i>Sreekanth</i>
18	14R11A04M6	Pranav Raju A	<i>Pranav Raju A</i>	<i>Pranav Raju A</i>
19	15R11A05K6	Sri Sheetal	<i>Sri Sheetal</i>	<i>Sri Sheetal</i>
20	15R11A05L7	Liya Rose	<i>Liya Rose</i>	<i>Liya Rose</i>
21	15R11A05Q0	Vishal	<i>Vishal</i>	<i>Vishal</i>
22	16R11A05E2	Rahul	<i>Rahul</i>	<i>Rahul</i>
23	15R11A05B0	Rohit ESSM	<i>Rohit ESSM</i>	<i>Rohit ESSM</i>
24	15R11A05B2	M. Vineetha	<i>M. Vineetha</i>	<i>M. Vineetha</i>
25	15R11A05B4	SK. Saleem	<i>SK. Saleem</i>	<i>SK. Saleem</i>
26	16R11A05C5	P. Vitham	<i>P. Vitham</i>	<i>P. Vitham</i>
27	16R11A0596	B. Manisha Reddy	<i>B. Manisha Reddy</i>	<i>B. Manisha Reddy</i>
28	15R11A05E7	M. Rahul Sai	<i>M. Rahul Sai</i>	<i>M. Rahul Sai</i>

PRINCIPAL
Geethanjali College of Engg. Tech.
Cheeryal (V), Keesara (M), R.R. Dist. (A.P.) - 501301

Geethanjali College of Engineering and Technology

The following students have received their certificates

(GCET & NSIC)

S.No	Roll No	Name	Branch	YeaR	Section	Sign
1	14R11A05K6	Garikipati Vineetha	CSE	4	D	G.Vineetha
2	15R11A05E7	M. Rahul Sai	CSE	3	C	M.Rahul Sai
3	15R11A05G5	SAIREDDY PRANITH REDDY	CSE	3	C	S.Pra
4	15R11A05A4	Polakonda sai vamshi	CSE	3	B	P.Vamshi
5	14R11A05L4	Katkam Sai Sri	CSE	4	D	K.Sai Sri
6	15R11A0508	D TEJA SAI SRINIVAS	CSE	3	A	D.Teja Sai
7	14R11A05K4	G Deepika	CSE	4	D	G.Deepika
8	15R11A05Q0	Danturty Sai Vishal	CSE	3	D	D.Vishal
9	15R11A05M0	Mrinal Moses Marshall	CSE	3	D	M.Mos
10	16R11A05B9	Nutikattu Aditya Sai Sumanth	CSE	2	C	N.Sumanth
11	15R11A05G6	Sandhya mourya	CSE	3	C	S.Sandhya
12	15R11A05H6	VALLALA SHIVA KUMAR YADAV	CSE	3	C	V.S.K.Yadav
13	15r11a05f5	P. Sri Sai Ram	CSE	3	C	P.Sri Sai Ram
14	15R11A05F3	Nanganoori maheshkumar	CSE	3	C	N.Mahesh
15	16R11A05E2	Rahul Ramesh Vinjamor	CSE	2	C	R.Vinjamor
16	16R11A05C5	Prerepa Vutham	CSE	2	C	P.Vutham
17	15R11A0595	Mutyala Sreekanth reddy	CSE	3	B	M.Sreekanth
18	15R11A0593	Shanthan Kumar Mudumba	CSE	3	B	S.Kumar
19	15R11A05B4	Shaik Saleem	CSE	3	B	S.Saleem
20	15R11A0594	MUKKA SAI KUMAR	CSE	3	B	M.Sai Kumar
21	15R11A05H9	Yarlagadda Prudhvik	CSE	3	C	Y.Prudhvik
22	15R11A05D5	Ega shravani	CSE	3	C	E.Shravani
23	15R11A0505	B VAMSHI	CSE	3	A	B.Vamshi
24	15R11A0550	E S S Manikanta Rohit	CSE	3	A	E.S.S.Rohit
25	16R11A05B8	N.Rahul chowdary	CSE	2	C	N.Rahul
26	14R11A05K1	Bugatha Bala Gayatri	CSE	4	D	B.Gayatri
27	16R11A05D1	Sadhu charan	CSE	2	C	S.Charan
28	16R11A05C1	MANISHA P	CSE	2	C	M.Manisha
29	15R11A05I7	Liya Rose	CSE	3	D	L.Rose
30		g.sri sheetal	CSE	3	d	G.Sheetal
31	16R11A05H7	M. nidhi	CSE	2	D	M.Nidhi
32		K VISHWATEJA	CSE	3	D	K.Vishwa
33	16R11A05G7	J RAJ SHEKAR	CSE	2	D	J.Raj
34		M VINEETHA	CSE	3	A	M.Vineetha
35	16R11A0596	B. Manisha Reddy	CSE	2	B	B.Manisha
36	14R11A04M6	Pranav Raju	ECE	4	D	P.Raju

PRINCIPAL

Geethanjali College of Engg. Techn.
Cheerl (V), Kamsara (M), R.R. Dist. (A.P.) - 501 307.



NSIC/TSC/HYD/TRG/2017-18

4th September 2017

PARTICIPATION CERTIFICATE

This is to certify that **Mr./Ms. K VISHWATEJA** (15R11A0585), pursuing 3rd Year B.Tech (CSE), from Geethanjali College of Engineering & Technology, has attended Three days workshop on “**ANDROID APPLICATION DEVELOPMENT**” from 12th AUGUST 2017 to 14th AUGUST 2017.

(Subodh Jaiswal)
GM & Centre Head



PRINCIPAL
Geethanjali College of Engg. Tech.
Cheeruvu (V), Keesara (M), R.R. Dist. (A.P.) - 501 301



NSIC/TSC/HYD/TRG/2017-18

4th September 2017

PARTICIPATION CERTIFICATE

This is to certify that **Mr./Ms. G SRI SHEETAL** (15R11A05K6), pursuing 3rd Year B.Tech (CSE), from Geethanjali College of Engineering & Technology, has attended Three days workshop on “**ANDROID APPLICATION DEVELOPMENT**” from 12th AUGUST 2017 to 14th AUGUST 2017.

(Subodh Jaiswal)
GM & Centre Head



PRINCIPAL
Geethanjali College of Engineering & Tech.
Choorayal (V), Keesara (M.P.), K.K. Dist. (A.P.) - 501 304.



NSIC/TSC/HYD/TRG/2017-18

4th September 2017

PARTICIPATION CERTIFICATE

This is to certify that **Mr./Ms. LIYA ROSE** (15R11A05I7), pursuing 3rd Year B.Tech (CSE), from Geethanjali College of Engineering & Technology, has attended Three days workshop on “**ANDROID APPLICATION DEVELOPMENT**” from 12th AUGUST 2017 to 14th AUGUST 2017.

(Subodh Jaiswal)
GM & Centre Head



PRINCIPAL
Geethanjali College of Engg. Tech.
Cheerla (V), Keesara (M), R.R. Dist. (A.P.) - 501 301



NSIC/TSC/HYD/TRG/2017-18

4th September 2017

PARTICIPATION CERTIFICATE

This is to certify that **Mr./Ms. MANISHA P** (16R11A05C1), pursuing 2nd Year B.Tech (CSE), from Geethanjali College of Engineering & Technology, has attended Three days workshop on “**ANDROID APPLICATION DEVELOPMENT**” from 12th AUGUST 2017 to 14th AUGUST 2017.

(Subodh Jaiswal)
GM & Centre Head



PRINCIPAL
Geethanjali College of Engg. Tech.
Geethanjali, Kamalanagar, R.R. Dist. (A.P.)-501 001.



NSIC/TSC/HYD/TRG/2017-18

4th September 2017

PARTICIPATION CERTIFICATE

This is to certify that **Mr./Ms. E S S MANIKANTA ROHIT (15R11A0550)**, pursuing 3rd Year B.Tech (CSE), from Geethanjali College of Engineering & Technology, has attended Three days workshop on **“ANDROID APPLICATION DEVELOPMENT”** from 12th AUGUST 2017 to 14th AUGUST 2017.

(Subodh Jaiswal)
GM & Centre Head



PRINCIPAL
Geethanjali College of Engg. Tech.
Chennarayana (V), Keosara (M), R.R. Dist. (A.P.) - 501 301



NSIC/TSC/HYD/TRG/2017-18

4th September 2017

PARTICIPATION CERTIFICATE

This is to certify that **Mr./Ms. SHANTHAN KUMAR MUDUMBA (15R11A0593)**, pursuing 3rd Year B.Tech (CSE), from Geethanjali College of Engineering & Technology, has attended Three days workshop on “**ANDROID APPLICATION DEVELOPMENT**” from **12th AUGUST 2017 to 14th AUGUST 2017.**

(Subodh Jaiswal)
GM & Centre Head



PRINCIPAL
Geethanjali College of Engg. Tech.
Geethanjali (V), Keosara (M), R.R. Dist. (A.P.) - 501 307



NSIC/TSC/HYD/TRG/2017-18

4th September 2017

PARTICIPATION CERTIFICATE

This is to certify that **Mr./Ms. MRINAL MOSES MARSHALL (15R11A05M0)**, pursuing 3rd Year B.Tech (CSE), from Geethanjali College of Engineering & Technology, has attended Three days workshop on “**ANDROID APPLICATION DEVELOPMENT**” from 12th **AUGUST 2017** to 14th **AUGUST 2017**.

(Subodh Jaiswal)
GM & Centre Head



PRINCIPAL
Geethanjali College of Engg. Techn.
Cheerpal (V), Keerana (M), R.R. Dist. (A.P.) 501 302



NSIC/TSC/HYD/TRG/2017-18

4th September 2017

PARTICIPATION CERTIFICATE

This is to certify that **Mr./Ms. DANTURTY SAI VISHAL (15R11A05Q0)**, pursuing 3rd Year B.Tech (CSE), from Geethanjali College of Engineering & Technology, has attended Three days workshop on “**ANDROID APPLICATION DEVELOPMENT**” from 12th AUGUST 2017 to 14th AUGUST 2017.

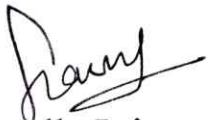
(Subodh Jaiswal)
GM & Centre Head



PRINCIPAL
Geethanjali College of Engg. Tech.
Cheerpal (V), Keesara (M), R.R. Dist. (A.P.) - 501 301



NSIC/TSC/HYD/TRG/2017-18

4th September 2017

PARTICIPATION CERTIFICATE

This is to certify that **Mr./Ms. B MANISHA REDDY (16R11A0596)**, pursuing 2nd Year B.Tech (CSE), from Geethanjali College of Engineering & Technology, has attended Three days workshop on “**ANDROID APPLICATION DEVELOPMENT**” from 12th AUGUST 2017 to 14th AUGUST 2017.

(Subodh Jaiswal)
GM & Centre Head



PRINCIPAL
Geethanjali College of Engg. Techn.
Geethanjali (V), Kaasara (M), R.R. Dist. (A.P.) - 501 301..

Geethanjali College of Engineering and Technology

Permanently Affiliated to JNTUH, Approved by AICTE, Accredited by NBA

Cheeryal(V), Keesara(M), R.R. Dist-501301

Department of Computer Science and Engineering

Android Workshop Date:12-08-2017 to 14-08-2017

Criteria 5-Strongly Agree 4-Agree to a large extent 3-Agree 2-Disagree 1-Strongly Disagree	1	2	3	4
1 The content was as described in brochure	4	4	4	5
2 The workshop was applicable to my area of interest	5	5	4	4
3 I will recommend this workshop to others	4	4	5	4
4 The program was well paced within the allotted time	4	3	5	3
5 The instructors were good communicators	5	5	5	5
6 The material was presented in an organized manner	5	4	4	5
7 The instructors were knowledgeable on the topics	4	5	5	4
8 The workshop improved my understanding of the topics	3	5	5	4
9 I understood the concepts presented in the workshop	4	4	4	4
10 The workshop improved my ability to utilize skills related to the topic.	4	5	5	4
11 The knowledge and skills I learned will be useful to me in my professional career.	5	5	5	4
12 I would attend other workshops offered by these facilitator(s) in future	5	5	5	5
13 I would be interested in attending a follow-up, more advanced workshop on this same subject	4	5	4	4
14				
15 Given the topic, was the workshop:(1. Too short, 2. Appropriate in length, 3. Too long)	2	2	2	2
16 In your opinion, was the workshop: 1. Introductory, 2. Intermediate, 3. Advanced	2	1	2	2

PRINCIPAL
Geethanjali College of Engg. Tech.
Cheeryal (V), Keesara (M), R.R. Dist. (A.P.) - 501301

5	6	7	8	9	10	11	12	13	14
4	4	5	4	5	5	4	4	4	5
4	5	5	4	5	4	4	4	4	5
5	5	4	4	5	5	5	5	4	5
4	5	4	4	5	5	4	5	4	5
4	5	5	4	4	5	5	5	4	5
4	4	5	4	5	4	4	5	4	5
5	4	5	4	5	5	5	5	4	3
5	4	4	4	5	4	4	4	4	5
4	4	5	4	5	5	4	4	4	4
4	5	5	4	4	4	4	4	4	4
4	4	4	4	5	5	5	5	4	3
4	4	5	4	5	5	5	4	4	5
5	3	5	4	5	5	5	4	4	5
2	1	2	1	2	2	2	2	2	2
1	1	1	1	2	2	2	2	2	2

PRINCIPAL
 Geethanjali College of Engg. Tech.
 Choeryal (V), Keesara (M), R.R. Dist. (A.P.) - 501 301

15	16	17	18	19	20	21	22	23	24
4	3	4	4	4	5	4	4	3	4
5	4	4	4	4	5	3	4	4	4
5	3	4	4	4	5	3	4	3	4
4	4	4	4	4	5	3	4	4	4
4	4	4	4	5	5	4	4	3	4
4	4	4	4	4	4	3	3	4	4
4	4	4	5	5	5	4	4	3	4
4	4	4	4	5	4	3	4	4	4
4	3	4	5	4	5	3	4	3	4
5	4	4	5	4	5	3	4	4	4
5	4	5	5	4	5	3	4	4	4
4	3	5	4	4	4	3	4	4	4
4	5	4	4	4	4	4	4	4	4
2	2	2	2	2	2	2	2	1	2
2	2	1	2	2	2	2	2	1	2



PRINCIPAL

Geethanjali College of Engg. Techn.
 Choeryal (V), Keesara (M), R.R. Dist. (A.P.) - 501 301

25	26	27	28	29	30	31	32	33	34
4	4	5	4	5	4	5	5	4	4
5	3	5	4	3	5	4	4	5	5
3	3	5	4	3	5	5	5	5	5
5	2	5	4	4	5	5	5	5	5
5	3	5	4	4	5	5	5	5	5
4	3	5	4	4	5	4	4	5	5
5	3	5	4	4	5	4	5	5	5
5	4	5	4	3	5	5	5	5	5
5	3	5	5	3	4	5	5	5	5
5	4	5	5	3	4	5	5	5	5
4	4	5	5	3	5	5	5	5	5
4	4	5	5	3	5	5	5	5	5
4	4	5	5	3	5	5	5	5	5
1	1	2	2	2	2	2	2	2	2
1	2	2	2	2	1	1	1	1	1

35	36	37	38	39	40	41	Avg
4	4	4	4	5	4	4	4.21951
3	4	4	3	4	4	4	4.19512
4	3	4	4	4	4	5	4.2439
4	3	3	4	4	5	4	4.19512
5	4	3	3	5	5	4	4.43902
5	4	3	4	5	4	4	4.19512
5	4	4	3	5	4	4	4.36585
5	4	4	3	4	4	3	4.21951
4	3	4	4	4	5	4	4.17073
4	3	3	4	4	4	4	4.2439
5	3	3	4	4	4	4	4.34146
5	3	3	4	4	4	4	4.31707
3	3	3	4	4	4	4	4.2439
2	2	2	2	2	2	2	1.87805
1	1	1	1	1	2	2	1.56098



PRINCIPAL
 Geethanjali College of Engg. Tech.
 Cheeryal (V), Keasara (M), R.R. Dist. (A.P.) - 501 301-

Handwritten signature in blue ink



Geethanjali College of Engineering and Technology
(UGC Autonomous)

CHEERYAL (V), KEESARA (M) - 501301, Telangana

Date: May 1st, 2017

To
The Principal
Geethanjali College of Engineering and Technology
Cheeryal
Telangana - 501301.

Respected Sir,

Sub: Procuring URL for android apps – Regd.

As per the previous discussion we had regarding the URL for all the apps the students will create, I have purchased the same.

The total cost incurred is Rs.9384.00 (Rs. Nine thousand three hundred and eighty four only). I request you to please reimburse this amount.

Thanking you

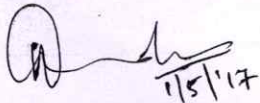

11/5/17

Prof. N. Chandrakanth
CSE
GCET

To
A/c

9/01/05/17

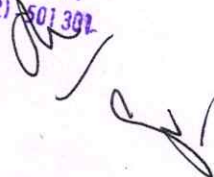
PRINCIPAL
Geethanjali College of Engg. Tech.
Cheeryal (V), Keesara (M), R.R. Dist. (A.P.) - 501301.





GoDaddy™

GoDaddy.com, LLC
14455 N. Hayden Rd.
Suite 219
Scottsdale, AZ 85260
(480) 505-8877

Invoice / Receipt

Date: Apr 27, 2017 4:53 PM

Invoice / Receipt #: 1125644670 .

Customer #: 154599083

Bill To:

geethajali college of engineering and technology

cheeryal village keesara mandal medchal district

hyderabad, TS 501301

+91.9000208680

Payment Information:

y shiva rao

MasterCard #####6004

Paid: Rs9,384.00

Items

.COM Domain Registration
geethanjaliapps.com

Item Number: 101

Quantity: 1

Term: 1

List Price: Rs959.00

Purchase Price: Rs599.00

PRINCIPAL
Geethanjali College of Engg. Tech.
Cheeryal (V), Keesara (M), R.R. Dist. (A.P.) - 501 301

ICANN Fee: Rs12.00

Discount: Rs599.00

Subtotal: Rs12.00

Taxes: Rs1.80
Total: Rs13.80

My Account | Order History | Receipt



Website Builder Business

Item Number: 1058162
Quantity: 1
Term: 1

List Price: Rs0.00
Purchase Price: Rs0.00
ICANN Fee: Rs0.00
Discount: Rs0.00
Subtotal: Rs0.00
Taxes: Rs0.00
Total: Rs0.00

Ultimate Linux Hosting with cPanel
geethanjaliapps.com

Item Number: 32082
Quantity: 1
Term: 1

List Price: Rs11,988.00
Purchase Price: Rs8,148.00
ICANN Fee: Rs0.00
Discount: Rs0.00
Subtotal: Rs8,148.00
Taxes: Rs1,222.20
Total: Rs9,370.20

Standard SSL
geethanjaliapps.com

Item Number: 3604
Quantity: 1
Term: 1

List Price: Rs4,399.00
Purchase Price: Rs0.00

PRINCIPAL
Geethanjali College of Engg. Techn.
Cheeryal (V), Keesara (M), R.R. Dist. (A.P.) - 501 301



Geethanjali College of Engineering and Technology
(UGC Autonomous)

CHEERYAL (V), KEESARA (M) - 501301, Telangana

Date: May 1st, 2017

To
The Principal
Geethanjali College of Engineering and Technology
Cheeryal
Telangana - 501301.

Respected Sir,

Sub: **Procuring URL for android apps – Regd.**

As per the previous discussion we had regarding the URL for all the apps the students will create, I have purchased the same.

The total cost incurred is Rs.9384.00 (Rs. Nine thousand three hundred and eighty four only). I request you to please reimburse this amount.

Thanking you

11/5/17

Prof. N. Chandrakanth

CSE

GCET

To
A/c

Sub
9) 01/05/17

PRINCIPAL
Geethanjali College of Engg. Tech.
Cheeryal (V), Keesara (M), R.R. Dist. (A.P.) - 501301



Chandra Nagulapalli <chandra.nagulapalli@gmail.com>

Central Hackathon Idea submission

1 message

jhub.jntuh <jhub.jntuh@gmail.com>

To: j-hub-SPoCs <j-hub-spocs@googlegroups.com>

Tue, Feb 13, 2019 at 9:22 AM

Dear SPoCs,

Thank you for the overwhelming response to the submission of ideas by your students for the central hackathon. we have received more than 200 ideas. A panel of mentors shall validate and shortlist the ideas based on the relevance of theme (Cyber-Physical Systems), uniqueness and novelty of Idea and other relevant parameters.

The shortlisted teams will be intimated by Thursday morning. Teams which are shortlisted are invited to participate in a two-day bootcamp on IoT with LoRa Technologies at JNTUH campus on Friday and Saturday (16th -17th Feb). The bootcamp shall help to enhance the practical knowledge of students by giving them hands-on learning experience and further refine their ideas for Hackathon

More detailed inputs on inventory that students should carry for the bootcamp and detailed instructions will be mailed shortly.

Any queries, feel free to mail at info@j-hub.in

regards
Team J-Hub

You received this message because you are subscribed to the Google Groups "j-hub-SPoCs" group.
To unsubscribe from this group and stop receiving emails from it, send an email to j-hub-spocs+unsubscribe@googlegroups.com.
To post to this group, send email to j-hub-spocs@googlegroups.com.
To view this discussion on the web visit <https://groups.google.com/d/msgid/j-hub-spocs/cdf5e4f2-797f-4213-8afb-d2cde881dfff%40googlegroups.com>.
For more options, visit <https://groups.google.com/d/optout>.

PRINCIPAL
Geethanjali College of Engg. and Tech.
Cheeryal (V), Keesara (M), Medchal Dist.(T.S.)-501 301.

Sno	Name of college	no of entries	Complete Presentation
1	Abhinav Hitec	2	2
2	ACE	23	17
3	Anurag Group of Institutio	14	3
4	BVRITH	11	7
5	Geethanjali	5	3
6	GNITS	8	7
7	GRIET	29	18
8	JNTUCES	4	4
9	JNTUCEH	17	14
10	JNTU-Jagatiyal	6	5
11	JNTU-Manthani	14	10
12	KITS-Khammam	2	2
13	MGIT	3	2
14	Sphoorthy	43	30
15	SNIST	6	5
16	Vidya Jyoti	2	1
17	blank	1	1
		190	131

PRINCIPAL
 Geethanjali College of Engg. and Tech.
 Cheeryal (V), Keesara (M), Medchal Dist (T.S.)-501 301.

SPoC Orientation program
Jhub:Jlabs
JNTUH Innovation Hub



Feb 2 2018

Jhub: Central hackathon
CYBERPHYSICAL SYSTEMS and INDUSTRY 4.0

IMPORTANT DATES:

- ▶ Idea Submission Feb 10
- ▶ Registration Link: tinyurl.com/jhubhack
- ▶ Registration Feb 12
- ▶ Hackathon Starts Feb 12
- ▶ Final Pitching Date: Feb 16-17
- ▶ Hackathon Ends Feb 23-24

Cyber Physical Systems

Theme: Cyber Physical Systems – Industry 4.0

A cyber-physical system (CPS) is a mechanism that is controlled or monitored by computer-based algorithms, tightly integrated with the internet and its users.

Examples of CPS include:

- Smart grid
- Autonomous automobile systems
- Medical monitoring
- Process control systems
- Robotics systems
- Automatic pilot systems
- Industrial IoT

IoT –LoRa
 EDGE computing
 AI
 ML
 AR/VR
 Drones

Launch of Jhub:Jlabs
JNTUH Innovation Hub



College Registration Guidelines
 Feb 2 2018

Objective: Innovation

- Excitement around innovation
 - Exposure (UG) to interesting products & startups
 - Teaser workshops & seminars
- Create a culture of "building" tech prototypes
 - Ideation, Experimentation, Prototypes
- Create tech product based startups.
 - Idea thru Prototypes
- Hub and Spoke model
 - Central Hub at Univ Campus (Jhub)
 - College level spokes (Jlabs)
 - Students & team from college level, get help from central Jhub
- Jhub will connect with T-Hub, State Innovation Cell and other city enablers

CREATING A CULTURE OF
 INNOVATION ACROSS
 JNTU COLLEGES

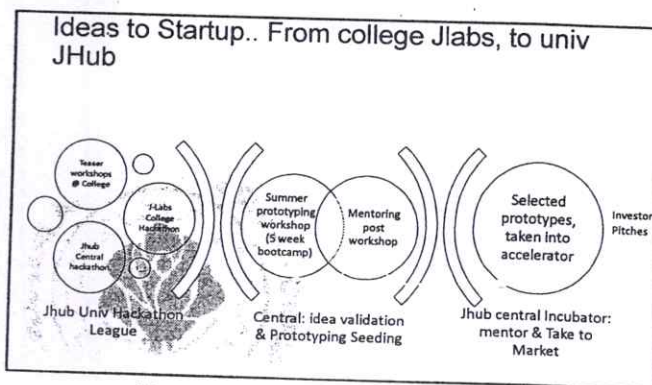

PRINCIPAL
Geethanjali College of Engg. and Tech.
 Cheeryal (V), Kaesara (H), Medchal Dist.(T.S.)-501 301.

Cyber Physical Systems

Theme: Cyber Physical Systems – Industry 4.0

A cyber-physical system (CPS) is a mechanism that is controlled or monitored by computer-based algorithms, tightly integrated with the Internet and its users.

Examples of CPS include

- Smart grid
- Autonomous automobile systems
- Medical monitoring
- Process control systems
- Robotics systems
- Automatic pilot avionic
- Industrial IoT

- IoT –LoRa
- EDGE computing
- AI
- ML
- AR/VR
- Drones

Central hackathon Steps

- Announcement: Feb 2
- Detailed Guidelines: Feb 3
- Idea submission Feb 10
- Registration form link: [tinyurl/jhubhack1](http://tinyurl.com/jhubhack1)
- Shortlisting Feb 12
- Inventory list Feb 12
- Deep Dive Boot Camp on Cyber physical systems - Industrial IoT Feb 16-17
- Hackathon Feb 23-24

EXCITE2k18

Ideation contests, Tech Bootcamps and Hackathons within college

Shortlisting based on participation at Bootcamps & Central Hackathon at J-hub

First SpoC Hub Camp on Feb 2 followed by Feb 16

First Central Hackathon on 23-24 Feb

POSTER FOLLOWS..

JNTU J-Hub – University Wide Innovation/Startup Program ANNOUNCEMENT

Excellence around innovation : Exposure (UG) to interesting products & startups; Tester workshops & seminars
 Create a culture of "building" tech prototypes: Ideation, Experimentation, Prototyping; Create high product based startups: Idea thru Prototypes
 Hub and Spoke model: Central Hub at JNTU campus (Jhub), College level spokes (Jlabs)
 Students & learn from college level, get help from central Jhub
 Jhub will connect with T-Hub, State Innovation Cell and other city enablers

JHub- Univ level, central
 Jlabs- College level

Ideas to Startups: From college labs, to univ JHub



Calendar..

Event	Date	Location
Ideation Contest	Feb 2	JNTU J-Hub
Tech Bootcamp	Feb 16	JNTU J-Hub
Central Hackathon	Feb 23-24	JNTU J-Hub
Startup Workshop	Feb 28	JNTU J-Hub

Interested? Sign up now.
 1st Year for 2018, 3rd Year for JCell

Thanks

PRINCIPAL
 Geethanjali College of Engg. and Tech.
 Chittoor, Andhra Pradesh, India



JHUB

TEQIP-3

ENLITE 2018
(BOOTCAMP ON INNOVATION & ENTREPRENEURSHIP)
CERTIFICATE OF MERIT

This is to certify that **M.N.:NIKIL..INDHU..KASHYAP.....** Student of **SVLET.....**
COLLEGE....OF..ENGINEERING..... successfully completed the Bootcamp **ENLITE 2018**
held during May 28th - June 8th, 2018 organized by J-HUB, JNTUH and was part of

TEAMS WITH:- which secured **MERIT** position. **FOR BEST INTERESTING IDEA**

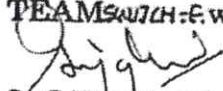
Dr. G. Vijaya Kumari
Director J-HUB, JNTUH

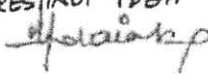
Dr. N. Yadaiah
Registrar, JNTUH

Powered by:  

PRINCIPAL
Geethanjali College of Engg. and Tech.
Cheerla (V), Keesara (M), Madhul Dist.(T.S.)-501 301.

Scanned by CamScanner



ENLITE 2018
(BOOTCAMP ON INNOVATION & ENTREPRENEURSHIP)
CERTIFICATE OF MERIT

This is to certify that P. ARVIND THILAK..... Student of GLET.....
COLLEGE OF ENGINEERING..... successfully completed the Bootcamp ENLITE 2018
held during May 28th - June 8th, 2018 organized by J-HUB, JNTUH and was part of
TEAMS WITH which secured MERIT position. FOR BEST INTERESTING IDEA

[Signature]
Dr. G. Vijaya Kumari
 Director J-HUB, JNTUH

[Signature]
Dr. N. Yadaiah
 Registrar, JNTUH

Powered by:

PRINCIPAL
 Geethanjali College of Engg. and Tech.
 Cheeryal (V), Keesara (M), Medchal Dist.(T.S.)-501 301.

... ..
... ..
... ..
... ..
... ..
... ..
... ..
... ..
... ..
... ..

... ..
... ..
... ..
... ..
... ..
... ..
... ..
... ..
... ..
... ..

PRINCIPAL
Geethanjali College of Engg. and Tech.
Cheeraj (V), Keesara (M), Medchal Dist.(T.S.)-501 301.



**ENLITE 2018
(BOOTCAMP ON INNOVATION & ENTREPRENEURSHIP)
CERTIFICATE OF MERIT**

This is to certify that P. ARVIND..THILAK..... Student of GLET.....
COLLEGE OF ENGINEERING..... successfully completed the Bootcamp ENLITE 2018
held during May 28th - June 8th, 2018 organized by J-HUB, JNTUH and was part of
TEAM SUTRA which secured MERIT position. FOR BEST INTERESTING IDEA

Dr. G. Vijaya Kumari
Director J-HUB, JNTUH

Dr. N. Yadaviah
Registrar, JNTUH

Powered by:

PRINCIPAL
Geethanjali College of Engg. and Tech.
Cheeryal (V), Kessara (M), Medchal Dist. (T.S.)-501 301

Scanned by CamScanner



Yvn Phanikishore <yvnphanikishore@gmail.com>

JHUB- JNTUH Boot Camp

1 message

Chandra Nagulapalli <chandra.nagulapalli@gmail.com>

To: prathyushac98@gmail.com, carol navya <carolnavya1999@gmail.com>, thilakarvind@gmail.com, eswar.hemanth143@gmail.com, kaushik.adusumilli9@gmail.com, sairamrao96@gmail.com
Cc: Yvn Phanikishore <yvnphanikishore@gmail.com>

Wed, May 9, 2018 at 11:14 AM

Dear All,
A Very good morning.

This is to inform all that the JNTUH - JHUB Bootcamp is scheduled from

28/05/2018 to 8/06/2018.

All the students are requested to get their own laptops during the bootcamp.

There will be a competition towards the end of the boot camp wherein you can win exciting prizes

Regards
N. Chandrakath.

PRINCIPAL
Geethanjali College of Engg. and Tech.
Cheeryal (V), Keesara (M), Medchal Dist.(T.S.)-501 301.

GĒETHANJALI COLLEGE OF ENGINEERING AND TECHNOLOGY					
BOOT CAMP STUDENT LIST					
S.No	Name	Roll No	Branch	Phone	Email
1	C. Prathyusha		CSE A	6300524858	prathyushac98@gmail.com
2	P. Carol Navya		CSE D	9618176142	carolnavya1999@gmail.com
3	P. Arvind Tilak		Mech	9177003048	thilakarvind@gmail.com
4	Majeti Eswar Hemanth		ECE	8885319264	eswar.hemanth143@gmail.com
5	A. Koushik		ECE	9704998784	kaushik.adusumilli9@gmail.com
6	C. Sai Ram Rao		ECE	7075653264	sairamrao96@gmail.com

 PRINCIPAL
 Geethanjali College of Engg. and Tech.
 Cheeryal (V), Keosara (M), Medchal Dist. (T.S.)-501 301.

J-HUB'S ENLITE

VENTURE VOYAGER GAME ON

PRE-ASSIGNMENT- MY E STYLE GURU

28TH MONDAY-INTRODUCTION

- 9.00-9.30 ATTENDANCE & REGISTRATION
9.30 -10.45 RULES OF GAME. - SHIKANDER TEAM MIX -GAME
10.45 -11.00 BREAK
11.00- 12.00 INAUGURATION
12.00 -12.30 E-CUBS TALK

a. urban talk – taskeen Fatima- taskeenfatimabasha@gmail.com- 9581453781

12.30 -1.30

TEAM NUMBERS-MENTORS MATCH -REGISTRATION

11.45- 12.00 E SPIRIT -PPT

b.

WORK ASSIGNMENT: 1- GENERATE 3 BUSINESS IDEAS EACH

29TH TUESDAY -IDEATION

- 9.30 -10.30AM -EXERCISES-- GENERATING IDEAS-DISRUPT/BRAINSTORM/MINDMAP
10.30- 11.30 - EVALUATING AN IDEA -5 Q -ROLEPLAY -CHAVAN ECLAIR
11.45 -1.00 E-CUBS TALK-HOW I GOT MY IDEA-

1. subash – primeauth -9618542274-pbss@primeauth.com
2. ashwithareddy@levelapp.in ASHITA- LEVEL-9160116055
3. digi dine -nikil- amigo@digidine.in -9000977879

PRINCIPAL
Geethanjali College of Engg. and Tech.
Chaerayi (V), Keesara (M), Medchal Dist. (T.S.)-501 301.

2ND JUNE SATURDAY INDUSTRY KNOWLEDGE

10.00 – 10.45 AM COMPETITION & 5 FORCE ANALYSIS.

10.45 -11.45 AM BUSINESS CLUES-PRODUCT/BRAND RECOGNITION GAME

11.45- 12.00 PM BREAK

12.00- 1.00PM E- TALKS : PIVOTS & PERSEVERE

1. SAI GUPTA ASAANPAY

2. kartik nani joymate

WORK ASSIGNMENT No.6: TEAM ANALYSIS- WORK FLOWS/JOBS TO CREATE AND FUNCTIONS- ORGANISATION CHART

WORK ASSIGNMENT NO: 7 - COSTS & REVENUE IDENTIFICATION

4TH JUNE MONDAY- FINANCE MODEL

10.00 – 10.45 AM COSTS & REVENUE MODEL

10.45 -11.45 AM ECONOMIC FEASIBILITY CHART

11.45- 12.00 PM BREAK

12.00- 1.00PM E- TALKS- TEAM & CAPITAL

1. BHARTI – FINE TRAIN

2. BALA -INVOLUTE ENGINEERING

WORK ASSIGNMENT No; 8 - OUR CUSTOMER -VALUE PROPOSITION & BUSINESS MODEL

5TH JUNE TUESDAY – TEAM WORK/DAY

10.00 – 10.45 AM IDENTIFICATION OF WORKPROCESS

10.45 -11.45 AM SHOP FLOOR SHOW - GAME

11.45- 12.00 PM BREAK

12.00- 1.00PM E- TALKS- WORKS PLAN-TASKS & JOBS-

1.MOMOS DIVYA

2. HEMA -COLOR DE EARTH

2.00- 3.30 -BUSINESS PLAN & PITCH

3.45 -4.30 E- TALKS- PITCHING & RAISING FUNDS

STARTUPSATURDAY-HAMAD/SONI/RENUKA

WORK ASSIGNMENT: NO 9- MY BUSINESS PLAN & EXECUTIVE SUMMARY(2 PAGES)

WORK ASSIGNMENT NO 10 PITCH

6TH JUNE WEDNESDAY – PITCH DAY

– SEMI FINALISTS PITCHING

PRINCIPAL
Geethanjali College of Engg. and Tech.
Cheerayal (V), Keesara (M), Medchal Dist.(T.S.)-501 307.

EXECUTIVE SUMMARY

- Hexd house interior and exterior design platform that will offer comprehensive interior and exteriors design services for homes and offices.
- Hexd is a simple app that enables anyone to create realistic interior and exterior designs.
- Hexd allows the customers to choose the items from a comprehensive catalog in order to plan and furnish their house and they can see what everything looks like in reality using the virtual reality mode.
- Hexd also allows the customers to buy the furniture, paints, electronic goods that best suits their house.
- This app offers the personalized services and target market desires and can afford in a way that is unique from concept to implementation.
- Recent market research indicates a specific and growing need in the area for interior and exterior design consulting services and products hexd interiors and exteriors offers the market it will serve.
- The approach to promote Hexd will be through establishing relationships with key people in the community.
- Hexd focuses on offering design solutions based on the clients taste, budget, use, and goals for the space.
- The additional selection, accessibility of product, design differentiate hexd from the other options.

MARKETING PLAN

- Hexd deals with various companies like paints companies, architectures, furniture companies etc and takes share from every company for making deal with client.
- Hexd is basically an app or a website. Free downloading of app and free registration, more number of designs, offers help us in establishing the image and identity of our brand.
- Among different segments like residential, commercial, corporate, Hexd works only on residential segments, where houses receive the hexd services.
- Hexd designs in markets are subdivided based on tastes and preferences of people.
- People of different genders can find the best designs. Sub-segments are based on gender, age group, income.
- Hexd services can be accessed by people through advertisements in Tv and the other sources like newspapers.
- Market access for goods are easily available
- Few of hexd goods are imported from other countries with the government permission.
- Hexd targets the middle class people who find difficulties in affording higher

- Roomsketcher
- IKEA
- GodrejInterio

PLANNER 5d

- Planner 5D is a simple-to-use app that enables anyone to create beautiful and realistic interior and exterior designs in 2D and 3D modes.
- You can choose interior and exterior items from a comprehensive catalog in order to plan and furnish your home or any other space the way you have always wanted, and you can see what everything looks like in reality using the Virtual Reality mode.
- 10,000,000+ downloads on Google Play
- 12,000,000+ interior and exterior designs created by our users
- 16,000,000+ Planner 5D users worldwide
- 1,000,000+ snapshots made
- Its rating is 4.3/5 in google play.
- Reference->(<https://play.google.com/store/apps/details?id=com.planner5d.planner5d&hl=en>)
- Planner 5d generates \$12.3k in revenue(owlers.com)

ROOMSKETCHER

- RoomSketcher competes in the renovation and interior design service field.
- In RoomSketcher customers can create their floor plans, home designs and office projects online.
- It allows the customers to draw or order from their floor plan services.
- Its an interactive floor plan that allows the customer to edit online.
- Its rating is 2.9/5 in google play.
- It has 100 thousand downloads in google play.
- Reference->(<https://www.roomsketcher.com>)
- It generates \$8M in revenue(owlers.com).

IKEA

- IKEA is global player in furniture industry and have good presence in india with outlets in major cities.
- IKEA has been present in India for last 30 years .It currently has 48 suppliers.
- It supports innovation and entrepreneurship and invests in modern manufacturing technology.(www.IKEA.com).
- The main financial principle of the IKEA is to grow by using our own resources.
- They re-invest a majority of their profits in existing and new IKEA stores, well as in product development.
- They provide quality at low price.

GODREJINTERIO

PRINCIPAL
Geethanjali College of Engg. and Tech.
Cheruvu (V), Keerava (M), Malappuram
686 501

HEXD.

Strengths

- The proven ability to establish excellent personalized client service.
- Strong relationships with suppliers that offer flexibility and respond to special product requirements.
- Good referral relationships with architects, complementary vendors, and local realtors.

Weaknesses

- Not established in a market where a variety of interior design options exist.
- Challenges of the seasonality of the business.

Opportunities

- A significant portion of our target market is desperately looking for the services Hexd will offer.
- Promising activity from new home construction activity.
- Changes in design trends can initiate home updating and, therefore, generate sales.

Threats

- Continued price pressure due to competition or the weakening market reducing contribution margins.
- Dramatic changes in design, including fabric colors and styles can present challenges to keep paced with what is desired by what is expected to be a leading-edge client base.
- Expansion of products and services offered by other sources .

->This analysis indicates solid potential success, but the weaknesses and threats must be recognized throughout the life of the venture

Positioning

- For the person that seeks to create a personalized and unique impression of her home, HEXD is the source for them.
- Clients will be impressed with services they received and outcome they have enjoyed.
- Unlike the other apps HEXD allows the customers/clients to design and furnish the interior and exterior of their house and provides a facility to buy the products online with quality certification.

Differentiation

- Chatbots to help customers in every aspect.
- Giving the possibility to buy electronic goods and furniture at a relatively lower price.
- Giving a special package of 50% offer - If the customer subscribes for this

Geethanjali College of Arts and Tech.
Chennai
Principal
Date: _____

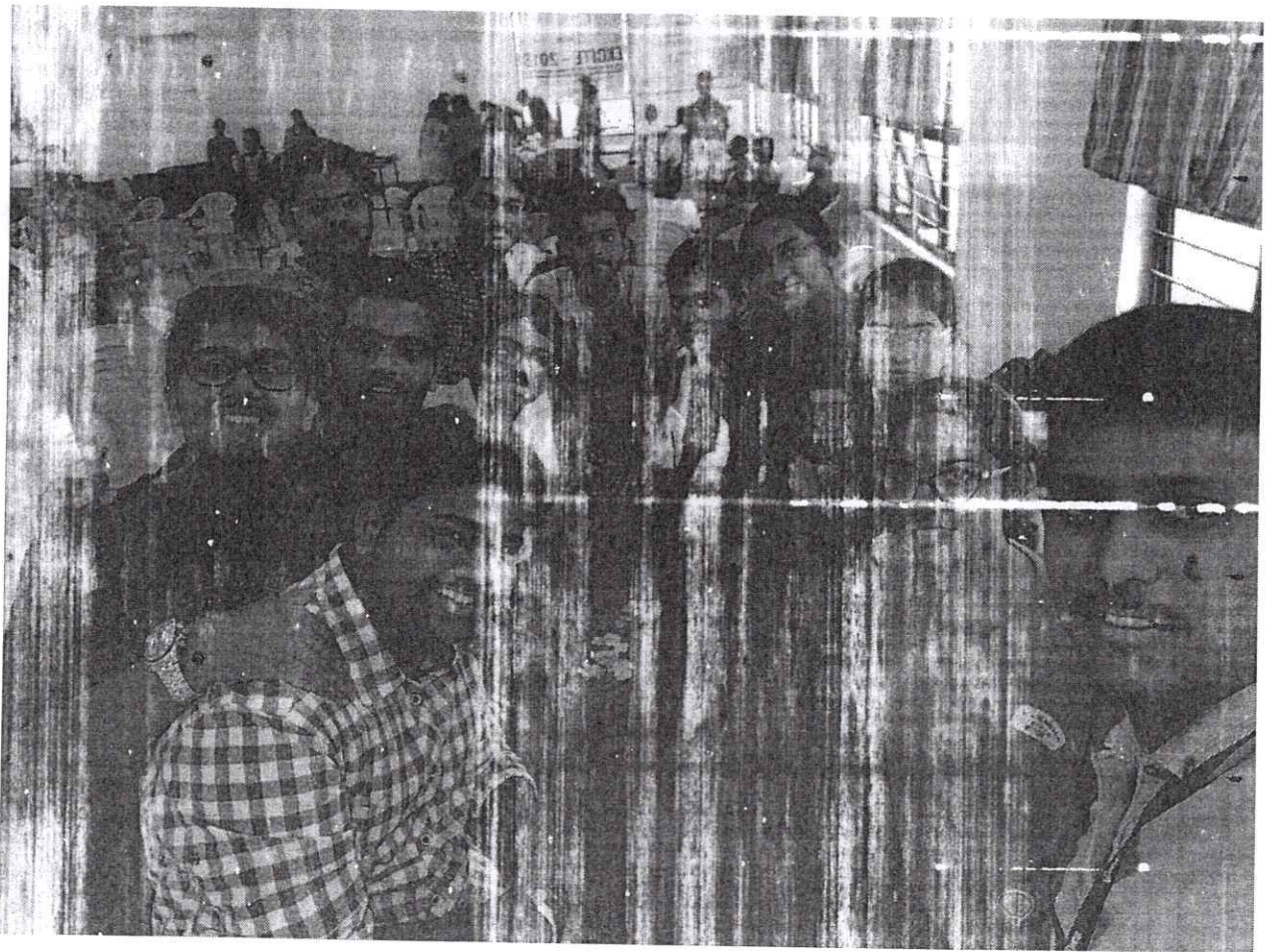
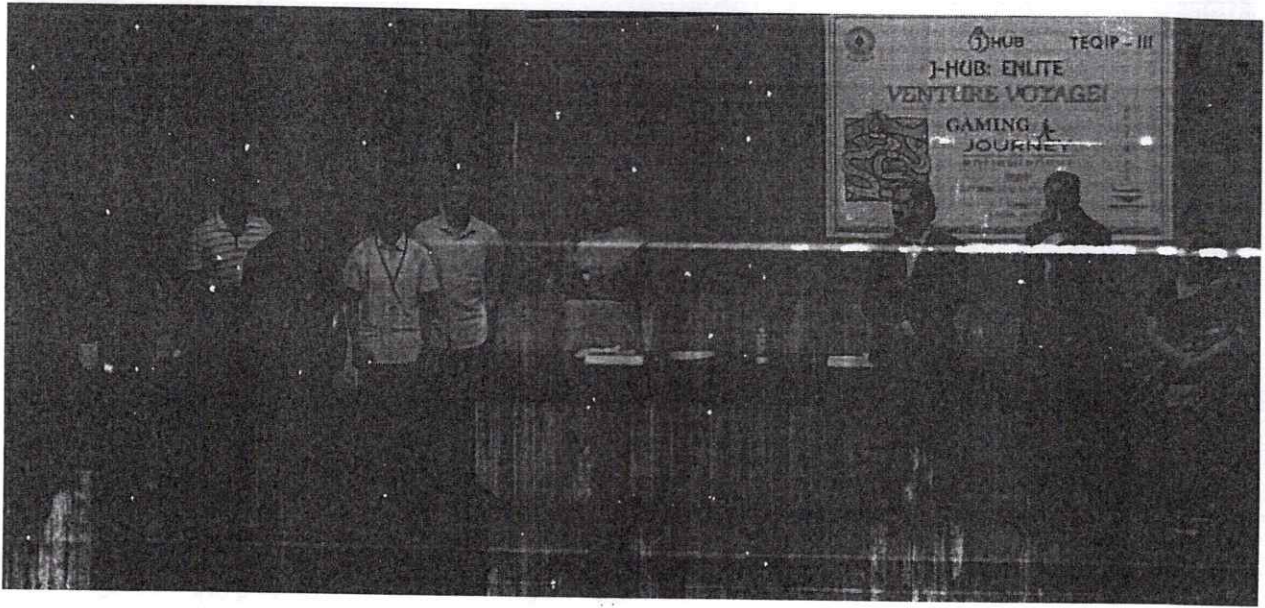

PRINCIPAL
Geethanjali College of Engg. and Tech.
Chennai (V) - Chennai (W), Tamil Nadu - 600 001

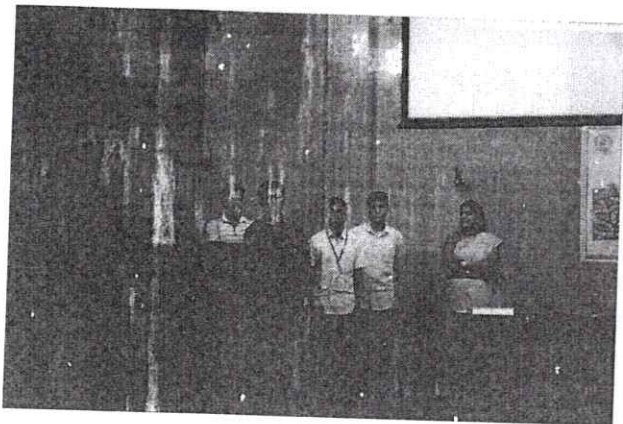

Principal
PRINCIPAL
Geethanjali College of Engg. and Tech.
Chennai (TN), Perambalur (TN), Madurai Dist (T.S. 501 301).

11:35

Responses **7** Export

INDIVIDUAL SUMMARY

1) Do you ever face the problem in designing your house interior and exterior?

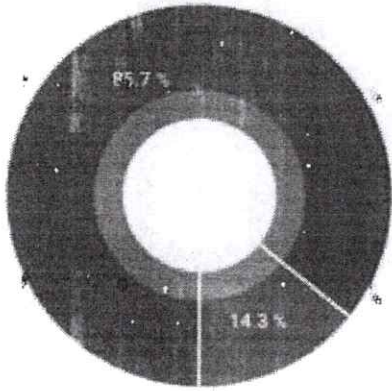

■ Yes (6) ■ No (1)

2) Do you even feel that you were selected products went wrong from your imagination as a reality?

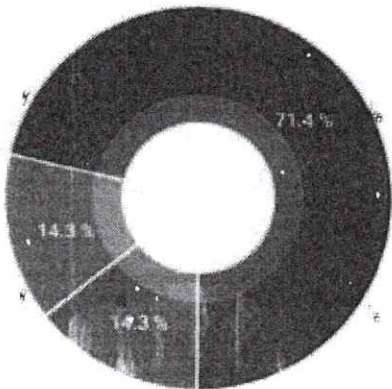

■ Yes (5) ■ No (1) ■ Maybe (1)

3) Do you really find the furniture which suits your interior design?

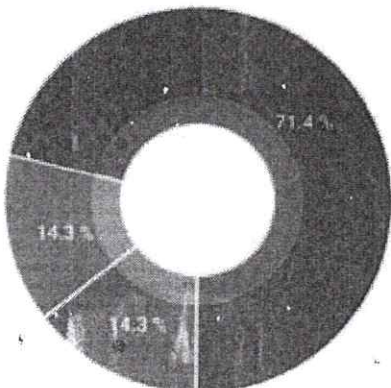

■ Very dissatisfied (1) ■ Not/less satisfied or dissatisfied (1) ■ Satisfied (5)

PRINCIPAL
 Geethanjali College of Engg. and Tech.
 Cheeryal (V), Keesara (M), Medchal Dist.(T.S.)-501 301.



J-HUB: ENLITE VENTURE VOYAGER 2018

TEAM NO:

DATE OF SUBMISSION:

TEAM :

TEAM EMAIL:

S.No	MySolution features	benefits	Possible challenges	Differentiation/changes to make/remarks
01				
02				
03				
04				
05				
06				

5. Identify the current solution(My Product) weaknesses. (e.g. costly, time, design, not compatible)-why they will not buy my product?
Recognise the setbacks or risks or problems in building the product. minimum three

S.No	Reasons not to buy	Risk/problem	notes
01			
02			
03			
04			
05			
06			

6. RECOGNISE THE DIFFRENTIATORS AND WRITE THE VALUE THEY PROVIDE.

1.
2
3
4
5

7. OUR PRODUCT VERSUS TOP TWO COMPETITION- A 5 FEATURES COMPARISON.

FEATURES	Compet-1	Compet-2	Our product	remarks

CONTACT DETAILS:

PRINCIPAL
Geethanjali College of Engg. and Tech.
Cheerayal (V), Keesara (M), Medchal Dist (T.S.)-501 301.





J-HUB: ENLITE VENTURE VOYAGER 2018

TEAM NO:

DATE OF SUBMISSION:

TEAM :

TEAM EMAIL:

WORKSHEET- 5 COMPETITION ANALYSIS

1. For the problem identified describe what solutions does the customer profilers CURRENTLY use?
2. Describe any five top currently used solutions for the identified problem & describe their unique features.

S.No	Solution name/competition	Features	Remarks
01			
02			
03			
04			
05			
06			

3. What is the price range they pay for these solutions?

S.No	Solution name/competition	Price	Remarks
01			
02			
03			
04			
05			
06			

4. Evaluate the current solution (My Product) designed by you..
(e.g costly, aesthetic, short, economical, value for consideration but low on satisfaction or has a host of other points)

CONTACT DETAILS:

PRINCIPAL
Geethanjali College of Engg. and Tech.
Cheeryal (V), Keesara (M), Medchal Dist.(T.S.)-581-301.





J-HUB: ENLITE
VENTURE VOYAGER 2018

TEAM NO:

DATE OF SUBMISSION:

TEAM :

TEAM EMAIL:

WORKSHEET- 3

LEGAL STRUCTURE & START-UP CHECKLIST

Reference Pages: 7 to 17

CONTACT DETAILS:

PRINCIPAL
Geethanjali College of Engg. and Tech.
Cheeryal (V), Keesara (M), Medchal Dist.(T.S.)-501 301.





J-HUB: ENLITE VENTURE VOYAGER 2018

TEAM NO:

DATE OF SUBMISSION:

TEAM :

TEAM EMAIL:

IDEA GENERATION SCORE:

WORKSHEET- 2B

MARKET SURVEY & CHECKLIST

QUESTIONNAIRE

PROBLEM STATEMENT: write your assumption of a problem here.---

PERSONAL PARTICULARS

- 1.NAME
2. ADDRESS
3. AGE
4. EMAIL
- 5.PHONE

PROBLEM VALIDATION QUESTIONAIRRE:

1. DO YOU FACE THE PROBLEM OF
YES NO
2. IF NO WHAT OTHER PROBLEM KEEPS YOU AWAKE AT NIGHT?
3. IF YES, WHO FACES THIS PROBLEM
4. IF YES WHEN DO YOU FACE THIS PROBLEM(FREQUENCY)
MOST FREQUENT (3TIMES AWEEK/DAILY)
MORE FREQUENT (ONCE A MONTH)
LESS FREQUENT (ONCE IN 3 MONTHS)
5. CURRENTLY WHAT SOLUTIONS YOU USE TO SOLVE THE PROBLEM.
6. WHAT DO YOU THINK WOULD BE A GREAT SOLUTION TO THIS PROBLEM?
7. WHAT PRICE POINT WOULD YOU BE WILLING TO PAY FOR SUCH A SOLUTION.

Format of one-page report:

1. Problem introduction-10 lines

CONTACT DETAILS:

PRINCIPAL
Geethanjali College of Engg. and Tech.
Cheruvu (V), Kousara (M), Madhul District (T.S.)-501 301.





J-HUB: ENLITE VENTURE VOYAGER 2018

TEAM NO:

DATE OF SUBMISSION:

TEAM :

TEAM EMAIL:

PRE-GAME WORKSHEET NO: 0

MATERIALS TO BE SENT ON 22ND MAY2018

1. 5 M QUIZ
2. SCORE SHEET
3. RESULTS
4. WHO AM I
5. SWS-0

Place a sticker on your shirt- saying your style & team no:

SUBMISSION WORKSHEET -0

COLLEGE NAME

MY TEAM NAME

MY EMAIL

MY MOBILE CONTACT-

MY TEAM MATES

1.

2.

3.

OUR TEAM COMBINATION

NAME OF MEMBER -

STYLE

OFFICE USE ONLY

TEAM COMBINATION SCORE:

CONTACT DETAILS:

*Geethanjali College of Engg. and Tech.
Cheeryal (V), Keesara (M), Madakal Dist.(T.S.)-501 301.*





J-HUB: ENLITE
VENTURE VOYAGER 2018

TEAM NO:

DATE OF SUBMISSION:

TEAM :

TEAM EMAIL:

WORKSHEET- 7

COST & REVENUE

Reference Pages: 13 to 15

CONTACT DETAILS:



BOOTCAMP on Innovation and Entrepreneurship

2 week Bootcamp on innovation / entrepreneurship is being organized for 8. Tech II year students. Each J-Lab shall nominate 2 teams of size 3 each. The Bootcamp is intensive programme covering ideation, product thinking and elements of venture establishment. The Bootcamp is scheduled during 2/3 week of May 2018

* Required

Name of the Team Member_1 *

C.Pratyusha

Contact Number *

6300524858

Email Id *

pratyushac98@gmail.com

Name of the Team Member_2 *

Name of the Team Member_2 *

P.Carol Navya

Contact Number *

9618176142

Email Id *

carolnavya1999@gmail.com

Name of the Team Member_3 *

Your answer

Contact Number *

Your answer

PRINCIPAL
 Geethanjali College of Engg. and Tech.
 Choarya (V), Koesara (M), Medchal Dist.(T.S.)-501 301.

5th May 2018

JHUB - Excite Kick-off Meeting

1. Excite program project to be realized as products.
Push for better than just Mini-projects.

2. May 17th - to June 30th.

- Prepared with Assignments. (Pre-workshop assignments)

- Reviewed by expert panel.

- Open Hackathons @ colleges

= 17th to 21st May - Curious Review

= from 21st we work on product.

your story. your
enterprise daily.

→ Boot Camp - 14 days. May 28th to June 8th
(2nd Year) - Prize.

{ Process Bee → Company
Venture Write - Game.

Venture Voyage →

- E-cub talk daily

Pre-Assignment for EXCITE :-

① - Problem validation (identification)

what problem does it solve?
Identification of real problem
+ How big?

② - Who has this problem? (Market) at least 3 to 4 segments.

③ - How unique is the solution?

④ - Defense against the competition. (competition analysis)

⑤ - Infrastructure.

Attendees:-

1) Dr. Vijaya Kurari (JNTUH)

2) Ramesh Loganathan (IIIT Hyd)

3) Pankaj (idealabs)

PRINCIPAL

Geethanjali College of Engg. and Tech.

Chennai (TN), Kozhikode (KL), Medical College

4. Chandrasekhar (GCET)

5. Phani Kishore (GCET)

&

SPOCs from various colleges.



Yvn Phanikishore <yvnphanikishore@gmail.com>

Second meeting with Institute Coordinator - 03/03/2018

4 messages

JNT UNIVERSITY HYDERABAD <jhub@jntuh.ac.in> Mon, Feb 26, 2018 at 1:04 PM
 To: vijaya saradhi <meduri_vsd@yahoo.co.in>, KANNARAO SHATARASI <skr2ece2ace@gmail.com>, Rajitha Reddy <rajitha.reddy87@gmail.com>, ramanareddy.a@bvrihyderabad.edu.in, priyakanth.r@bvrihyderabad.edu.in, madhavi.r@bvrihyderabad.edu.in, anilkumar.y@bvrihyderabad.edu.in, padmavati.e@bvrihyderabad.edu.in, guruswamy.r@bvrihyderabad.edu.in, cvr placement <cvr.placement@gmail.com>, placement@cvr.ac.in, vishnuvandanamba@cvsr.ac.in, kumarneerajece@cvsr.ac.in, Chandra Nagulapalli <chandra.nagulapalli@gmail.com>, ogirala.sivakumar@gmail.com, info@gcet.edu.in, Harish Pulluri <harishpulluri210@gmail.com>, Yvn Phanikishore <yvnphanikishore@gmail.com>, Principal Gnits <principal@gnits.ac.in>, S Ramacharan <s.ramacharan@gmail.com>, malini devi <gmalini12@gmail.com>, kalyani_nara@rediffmail.com, lalitha smiley <lalitha.malla@gmail.com>, Jeevan Nag <jeevannagendra@gmail.com>, pradeepredygriet@gmail.com, Kits Kmm <kits.kmm@gmail.com>, m v N MARUTI <amvnmaruti@gmail.com>, sreevani@mgit.ac.in, Vijay Kumar Damera <dameravijaykumar@gmail.com>, ramesh.me@nmrec.edu.in, krishna pagidimarri <pagidimarrik@gmail.com>, Principal Sphoorthy <principal.sphoorthy@gmail.com>, Pavan Kumar Katkuri <pavankumarkatkuri@gmail.com>, principal@sreenidhi.edu.in, "Dr. Ameet Chavan" <ameetchavan@sreenidhi.edu.in>, Sundaragiri Dheeraj <dheerajs@sreenidhi.edu.in>, smec2002principal@gmail.com, Gopi Krishna Saramekala <gopi.saramekala@gmail.com>, hodmba@smeac.ac.in, sai krish mskmurthy1003@gmail.com>, Dr Padmaja M <principalvjit@vjit.ac.in>, siddhartha@vjit.ac.in, Goutham Mannava <goutham_s_mannava@hotmail.com>, madan 324 <madan324@gmail.com>, Arun Ganji <arun.ganji@gmail.com>, Placements Vbit <placementofficer.vbit@gmail.com>, narayanarao_svn@vnrvjiet.in, S V S S SRINIVASA RAJU <svsssraju@gmail.com>, swetha.perumalla1@gmail.com, vijaya Lode <vijayalode@gmail.com>

Dear Sir/Madam.

Greetings from JHUB.

The second meeting of the Institution Coordinators is scheduled on March 3rd, 2018 at 10:30am at JHUB , 1st floor Admission block JNTUH campus.

The agenda of the meeting is as follows:

1. Brief 2-3 slide presentation of coordinators about the activities organized for 2nd year students and Best practices on Innovation and Entrepreneurship at the institute.
2. Brain storming on topics for technical workshops to be conducted for students during March 2018.
3. SPoC training programmes.

The meeting shall conclude by 1pm and will be followed by lunch.

Kindly confirm the name of the SPoC attending the meeting to make logistic arrangements.

Regards...

Dr. G. Vijayakumari
 Director of J-HUB
 JNTUH.

PRINCIPAL
 Geethanjali College of Engg. and Tech.
 Chennyl (V), Xeesara (M), Madchal Dist.(T.S.)-581 301.

Chandra Nagulapalli <chandra.nagulapalli@gmail.com> Tue, Feb 27, 2018 at 11:43 AM
 To: JNT UNIVERSITY HYDERABAD <jhub@jntuh.ac.in>
 Cc: Yvn Phanikishore <yvnphanikishore@gmail.com>, Udaya Susarla <uksusarla@gmail.com>

5/31/2018

Gmail - Phase-II Selection List for Bootcamp and Hackathon

<kits.kmm@gmail.com>, m v N MARUTI <amvnmaruti@gmail.com>, sreevani@mgit.ac.in, Vijay Kumar Damera <dameravijaykumar@gmail.com>, ramesh.me@nmrec.edu.in, krishna pagidimarri <pagidimarrik@gmail.com>, Principal Sphoorthy <principal.sphoorthy@gmail.com>, Favan Kumar Katkuri <pavankumarkatkuri@gmail.com>, principal@sreenidhi.edu.in, "Dr. Ameet Chavan" <ameetchavan@sreenidhi.edu.in>, Sundaragiri Dheeraj <dheerajs@sreenidhi.edu.in>, smec2002principal@gmail.com, Gopi Krishna Saramekala <gopi.saramekala@gmail.com>, hodmba@smec.ac.in, sai krrish <mskmurthy1003@gmail.com>, Dr Padmaja M <principalvjit@vjit.ac.in>, siddhartha@vjit.ac.in, Goutham Mannava <goutham_s_mannava@hotmail.com>, madan 324 <madan324@gmail.com>, Arun Ganji <arun.ganji@gmail.com>, Placements Vbit <placementofficer.vbit@gmail.com>, narayanarao_svn@vnrvjiet.in, S V S SRINIVASA RAJU <svssraju@gmail.com>, principal ceh <principal.ceh@jntuh.ac.in>, "Dr. K.P. Supreethi" <supreethi.pujari@jntuh.ac.in>, Dr N V Ramana <nvrjntu@jntuh.ac.in>, Suresh Kumar <sureshsanampudi@gmail.com>, swetha.perumalla1@gmail.com, "Dr. R. Markhandeya" <marksravvala@jntuh.ac.in>, "Dr. B.Vishnu Vardhan" <mailvishnu@jntuh.ac.in>, "Dr. Shahu Chatrapati" <shahujntu@jntuh.ac.in>, Shahu Chatrapati <shahujntu@gmail.com>, Principal Jntuhces <principaljntuhces@jntuh.ac.in>, narsimha Gugulothu <narsimha06@gmail.com>

Dear All

Please ignore the 2nd page in the pdf attached. Inconvenience regretted.

Regards...

Dr. G. Vijayakumari
Director of J-HUB
JNTUH.

[Quoted text hidden]

PRINCIPAL
Geethanjali College of Engg. and Tech.
Cheruvu (V), Keosara (M), Medchal Dist.(T.S.)-501 301.

Sno	Name of college	no of entries	Complete Presentation
1	Abhinav Hitec	2	2
2	ACE	23	17
3	Anurag Group of Instituti	14	3
4	BVRITH	11	7
5	Geethanjali	5	3
6	GNITS	8	7
7	GRIET	29	18
8	JNTUCES	4	4
9	JNTUCEH	17	14
10	JNTU-Jagatiyal	6	5
11	JNTU-waranhani	14	10
12	KITS-Khammam	2	2
13	MGIT	3	2
14	Sphoorthy	43	30
15	SNIST	6	5
16	Vidya Jyoti	2	1
17	blank	1	1
		190	131

PRINCIPAL
 Geethanjali College of Engg. and Tech.
 Cheeryal (V), Keesara (M), Medchal Dist. (T.S.)-501 301.

Submission number	Name	email	Phone	Name of College	What Industry /domain does your idea best represent	Describe your idea in less than 100 words
1	K.Ramya Sai	ramyasaik08@gmail.com	8977026440	ACE ENGINEERING COLLEGE	Industrial IOT	A technique is developed to detect manhole covers on the streets. Vehicles on the road have a great impact on the cover detection rate. Using this we can cover the manholes with lid by the arrival of vehicles and we can detect them during floods with signal and inform to municipal office
12	ROHITH KUMAR KATTA	ROYAL.RK@GMAIL.COM	+919399996636	GRIET	IOT (INTERNET OF THINGS)	The problems that facing by the farmers by natural calamities like floods, THUNDERS, Etc. That which causes most Damages to there life. For that cause we making a device that can work it self without being the farmer. It saves the Electronic device from the Burning, its works like farmer ROBOT.
13	Ganesh Srivatsa Kalahasti	gani.victory@gmail.com	8074592538	ACE ENGINEERING COLLEGE	Medical Monitoring	The main objective of my idea is to keep the human Blood pressure (BP), heart functioning and happening of hypoglycemia being monitored constantly and detect its abnormality.
15	K Madhumitha Reddy	madhur_nithareddyk@gmail.com	8801090012	JNTUHCCH	Robotics	The HEART of any ROBOTIC ENTITY is the proper control of the DC motors. We intend to create an intelligent cleaning robot which once installed does not need any human monitoring. In this way, one does not have to bother about switching on the robot everyday and be able to keep the surroundings neat.

27	G. Prashanth Kumar	prashanth013196@gmail.com	9700847600	GEETHANJALI COLLEGE OF ENGINEERING AND TECHNOLOGY	Medical Monitoring System	In India due to traffic signaling system and various other reasons ambulances are getting late, which results in loss of lives! To this purpose, an advanced traffic signaling system is proposed that is capable of detecting the ambulance from far area and clear the traffic according to the need.
31	ROHAN MAJUMDAR	rhnrmjmdr669@gmail.com	83333802747	JNTU-JAGTYAL	Medical Monitoring System	Constantly monitoring the patient's Heart beat, Blood Pressure and Temperature from a smart wearable using Bluetooth sensor from the watch. The system will be trained by a anomaly Detection Algorithm by which any anomaly(exception) will be detected and alerted to nearest hospital.
33	K.Abhiram Varma	abhiram040@gmail.com	9849558075	GRIET	INDUSTRIAL IOT	Temperature, humidity control had become a major challenge. Our idea is to monitor the industrial temperature and humidity in industries and also use a smart water coolant pumping for machinery. We use two temperature sensors namely DHT11 and DS18B20. Data is pushed to cloud using MQTT protocol.
35	BHARATH KUMAR GOUD SATHURI	sathuribharathbrothers1234@gmail.com	91333430813	Sreenidhi Institute of Science and Technology	Computer Science & Engineering/Natural Language Processing	There is no existing software for generating subtitles for a live video. We are trying to develop a software which generates subtitles for a live video by taking the audio from speech and sending them to cloud to get the text by using speech API and sending text to broadcasting centers to telecast.



Yvn Phanikishore <yvnphanikishore@gmail.com>

Phase-II Selection List for Bootcamp and Hackathon

2 messages

Wed, Feb 21, 2018 at 1:24 PM

JNT UNIVERSITY HYDERABAD <jhub@jntuh.ac.in>
 To: vijaya saradhi <meduri_vsd@yahoo.co.in>, KANNARAO SHATARASI <skr2ece2ace@gmail.com>, Rajitha Reddy <rajitha.reddy87@gmail.com>, ramanareddy.a@bvrithyderabad.edu.in, priyakanth.r@bvrithyderabad.edu.in, madhavi.r@bvrithyderabad.edu.in, anilkumar.y@bvrithyderabad.edu.in, padmavati.e@bvrithyderabad.edu.in, guruswamy.r@bvrithyderabad.edu.in, cvr placement <cvr.placement@gmail.com>, placement@cvr.ac.in, vishnuvandanamba@cvsr.ac.in, kumarneerajece@cvsr.ac.in, Chandra Nagulapalli <chandra.nagulapalli@gmail.com>, ogirala.sivakumar@gmail.com, info@gcet.edu.in, Harish Pulluri <harishpulluri210@gmail.com>, Yvn Phanikishore <yvnphanikishore@gmail.com>, Principal Gnits <principal@gnits.ac.in>, S Ramacharan <s.ramacharan@gmail.com>, rajkumar_lb2@yahoo.com, malini devi <gmalini12@gmail.com>, kalyani_nara@rediffmail.com, lalitha smiley <lalitha.malla@gmail.com>, Jeevan Nag <jeevannagendra@gmail.com>, pradeepreddygriet@gmail.com, Kits Kmm <kits.kmm@gmail.com>, m v N MARUTI <amvnmuruti@gmail.com>, sreevani@mgit.ac.in, Vijay Kumar Damera <dameravijaykumar@gmail.com>, ramesh.me@nmrec.edu.in, krishna pagidimarri <pagidimarri@gmail.com>, Principal Sphoorthy <principal.sphoorthy@gmail.com>, Pavan Kumar Katkuri <pavankumarkatkuri@gmail.com>, principal@sreenidhi.edu.in, "Dr. Ameet Chavan" <ameetchavan@sreenidhi.edu.in>, Sundaragiri Dheeraj <deerajs@sreenidhi.edu.in>, smec2002principal@gmail.com, Gopi Krishna Saramekala <gopi.saramekala@gmail.com>, kmba@smec.ac.in, sai krrish <mskmurthy1003@gmail.com>, Dr Padmaja M <principalvjit@vjit.ac.in>, siddhartha@vjit.ac.in, Goutham Mannava <goutham_s_mannava@hotmail.com>, madan 324 <madan324@gmail.com>, Arun Ganji <arun.ganji@gmail.com>, Placements Vbit <placementofficer.vbit@gmail.com>, narayanarao_svn@vnrvjiet.in, V S S SRINIVASA RAJU <svsssraju@gmail.com>, principal ceh <principal.ceh@jntuh.ac.in>, "Dr. K.P. Supreethi" <supreethi.pujari@jntuh.ac.in>, Dr N V Ramana <nvrjntu@jntuh.ac.in>, Suresh Kumar <sureshsanampudi@gmail.com>, swetha.perumalla1@gmail.com, "Dr. R. Markhandeya" <marksravvala@jntuh.ac.in>, "Dr. B.Vishnu Vardhan" <mailvishnu@jntuh.ac.in>, "Dr. Shahu Chatrapati" <shahujntu@jntuh.ac.in>, Shahu Chatrapati <shahujntu@gmail.com>, Principal Jntuhces <principaljntuhces@jntuh.ac.in>, narsimha Gugulothu <narsimha06@gmail.com>

Dear Sir/Madam

The following ideas have been shortlisted for mentoring and further refinement during the central Hackathon on 23-24 Feb 2018. Feasible ideas after mentoring will be participating in the Hackathon. The students are therefore informed to report at 9 AM on Feb23rd, 2018 at JHUB, along with ppt of their ideas and laptops and other hardware required.

Regards...

Dr. G. Vijayakumari
 Director of J-HUB
 JNTUH.

Phase2-Idea_Mentoring_Finalized_List_21-02-2018.pdf
 19K

PRINCIPAL
 Geethanjali College of Enng. and Tech.
 Chevuru (An. Yarrampet), JNTUH Hyderabad

Wed, Feb 21, 2018 at 1:30 PM

JNT UNIVERSITY HYDERABAD <jhub@jntuh.ac.in>
 To: vijaya saradhi <meduri_vsd@yahoo.co.in>, KANNARAO SHATARASI <skr2ece2ace@gmail.com>, Rajitha Reddy <rajitha.reddy87@gmail.com>, ramanareddy.a@bvrithyderabad.edu.in, priyakanth.r@bvrithyderabad.edu.in, madhavi.r@bvrithyderabad.edu.in, anilkumar.y@bvrithyderabad.edu.in, padmavati.e@bvrithyderabad.edu.in, guruswamy.r@bvrithyderabad.edu.in, cvr placement <cvr.placement@gmail.com>, placement@cvr.ac.in, vishnuvandanamba@cvsr.ac.in, kumarneerajece@cvsr.ac.in, Chandra Nagulapalli <chandra.nagulapalli@gmail.com>, ogirala.sivakumar@gmail.com, info@gcet.edu.in, Harish Pulluri <harishpulluri210@gmail.com>, Yvn Phanikishore <yvnphanikishore@gmail.com>, Principal Gnits <principal@gnits.ac.in>, S Ramacharan <s.ramacharan@gmail.com>, rajkumar_lb2@yahoo.com, malini devi <gmalini12@gmail.com>, kalyani_nara@rediffmail.com, lalitha smiley <lalitha.malla@gmail.com>, Jeevan Nag <jeevannagendra@gmail.com>, pradeepreddygriet@gmail.com, Kits Kmm

https://mail.google.com/mail/u/0/?ui=2&ik=0c6e1d5ee0&jsver=-dxVnc9Y02g.en.&cbl=gmail_fe_180516.06_p8&view=pt&q=jhub&qs=true&search=query&th=161



Yvn Phanikishore <yvnphanikishore@gmail.com>

Fwd: JHUB - Activity Plan

1 message

Chandra Nagulapalli <chandra.nagulapalli@gmail.com>

To: Udaya Susarla <uksusarla@gmail.com>, Yvn Phanikishore <yvnphanikishore@gmail.com>

Fri, Jan 26, 2018 at 1:15 PM

----- Forwarded message -----

From: "JNT UNIVERSITY HYDERABAD" <jhub@jntuh.ac.in>

Date: 26-Jan-2018 12:37 PM

Subject: JHUB - Activity Plan

To: "vijaya saradhi" <meduri_vsd@yahoo.co.in>, "KANNARAO SHATARASI" <skr2ece2ace@gmail.com>, <ramanareddy.a@bvrithyderabad.edu.in>, <priyakanth.r@bvrithyderabad.edu.in>, "cvr placement" <cvr.placement@gmail.com>, <vishnuvandana@cvr.ac.in>, "Chandra Nagulapalli" <chandra.nagulapalli@gmail.com>, <ogirala.sivakumar@gmail.com>, "S Ramacharan" <s.ramacharan@gmail.com>, "Principal Gnits" <principal@gnits.ac.in>, "malini devi" <gmalini12@gmail.com>, "Jeevan Nag" <jeevannagendra@gmail.com>, <pradeepreddygriet@gmail.com>, "Kits Kmm" <kits.kmm@gmail.com>, "Vijay Krishna" <dameravijay@gmail.com>, "shyam pabboju" <shyampabboju@gmail.com>, <ramesh.me@nmrec.edu.in>, "krishna pagidimarri" <pagidimarri@gmail.com>, "Pavan Kumar Katkuri" <pavankumarkatkuri@gmail.com>, <swethamanghnani14@gmail.com>, <principal@sreenidhi.edu.in>, <smec2002principal@gmail.com>, <siddhartha@vjit.ac.in>, <goutam_s_mannava@hotmail.com>, "Arun Ganji" <arun.ganji@gmail.com>, "SriVidya Yenumula" <svidya.y@gmail.com>, <narayanarao_svn@vnrvjiet.in>, "S V S S SRINIVASA RAJU" <svsssraju@gmail.com>, "principal ceh" <principal.ceh@jntuh.ac.in>, "Principal Jntuhces" <principaljntuhces@jntuh.ac.in>, <marksravvala@yahoo.co.in>, "Dr N V Ramana" <nvrjntu@jntuh.ac.in>, "Suresh Kumar" <sureshsanampudi@gmail.com>

Cc:

Dear Sir/Madam

Please find the attached files.





Regards...

Dr. G. Vijayakumari

Director of J-HUB

JNTUH.

4 attachments

-  **1 JHub-ActivityPlan-25Jan2018-1.pptx**
883K
-  **2 EXCITE2k17-Tracking Achievements.pptx**
2409K
-  **3 J-Hub Activity Calendar.pptx**
44K
-  **New Microsoft Office PowerPoint Presentation.pptx**
82K

PRINCIPAL
 Geethanjali College of Engg. and Tech.
 Cheeryal (V), Keesara (M), Medchal Dist.(T.S.)-501 301.

J-HUB

JNTUH Innovation Hub Launch of Activity Plan



Jan 25, 2018

The Vision

- Build Culture of Innovation to compete in the kn
- Applied Research to build tech intensive enterpri
- Create a unique HUB of programs, facilities and n a focal point for tech-startup incubation.



Members of Advisory Council

Industry Organization Leaders	Rajime V Lakshmi Kanth Devaraker Surana	VP, TCS & Chairman, CII Bangalore MD, Broadridge India
Tech Industry Leaders	Ranga Pothula Subramanyam Venkatarathin	Chairman, PCCETTS VP, CA Technologies
Product Initiative Leaders	Isaac Rajkumar Seshu Rao	Center Head, Infor MD, Opentext India
Startup Enablers	Viveck Verma Shanku Thojam	Hyssa Prakash Forum Hyderabad Hackers Steering council
Research Innovation	Vijay Bawa Deepak Anupallu	Nasscom IOK Startups Co-founder & Head of Engineering, Wavemaker/Pharmab
Convener	Prof.Ramesh Loganathan Dr.Wijayakumari	IIT-H Head CIE Director, JNTUH Innovation Hub
Chairman	Dr.A.VenuGopal Reddy	Vice-Chancellor, JNTUH

JHub- Univ level, centra JLabs- College level

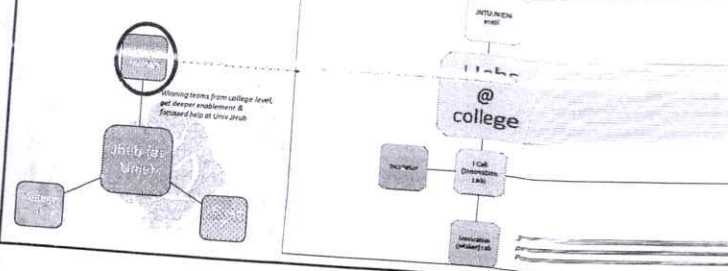

Activities Planned

- Hackathon Leagues
- Mentor meetings
- Summer Product Engineering Workshop- EXCITE
- Technology Deep Drive Workshops
- Hub camp
- Idea Competitions
- B-Plan Contests
- Entrepreneurship Programs
- Accelerator Program

FACILITIES PLANNED

- Event Space
- Accelerator
- Laboratory Space
- Conference Space
- Makers Lab/ Rapid Prototyping Lab
- Base Camp
- Co-working Space
- Collaboration Space

PRINCIPAL
Geethanjali College of Engg. and Tech.
Cheeryal (V), Kaesara (M), Medchal Dist.(T.S.)-501 301.

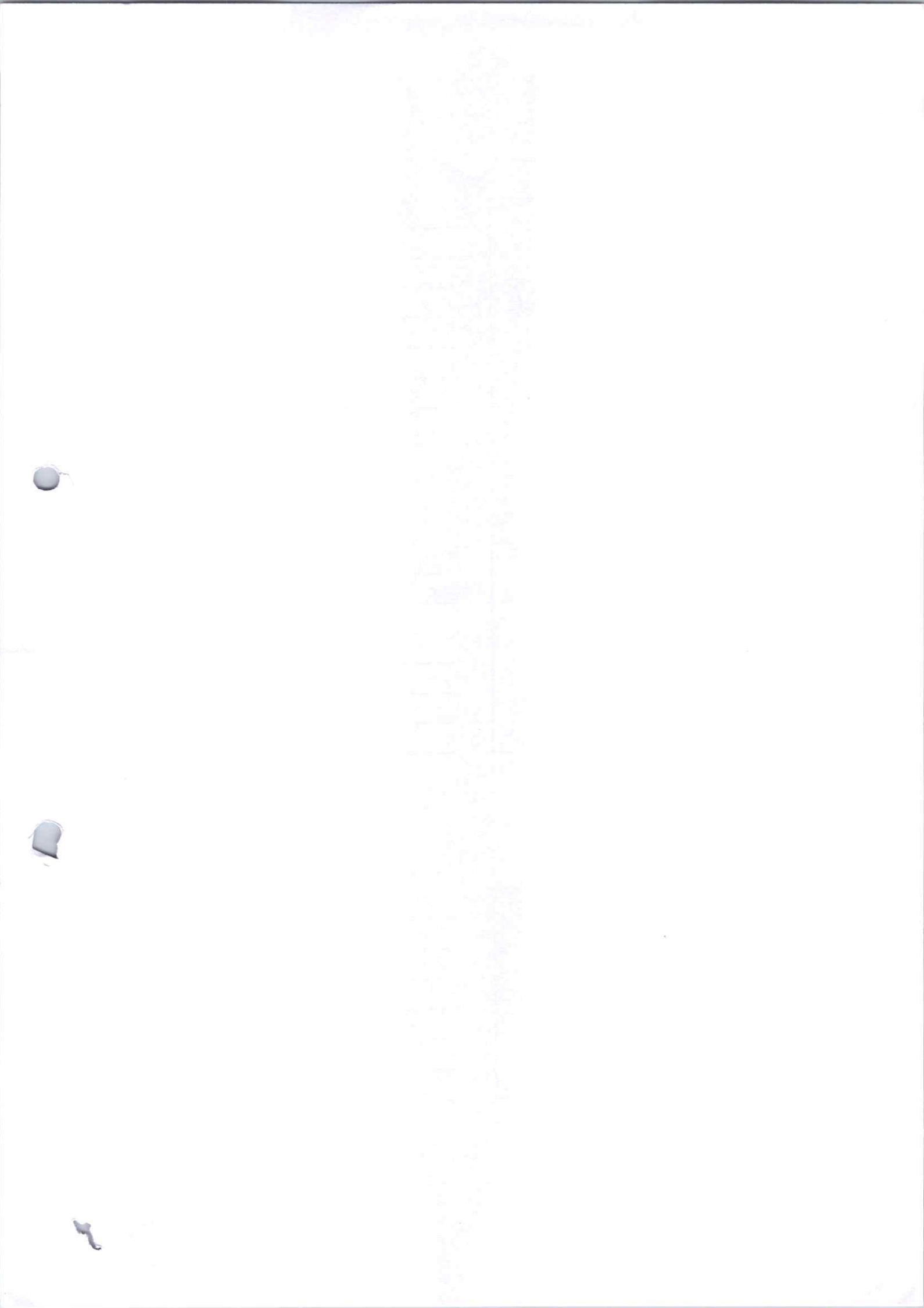

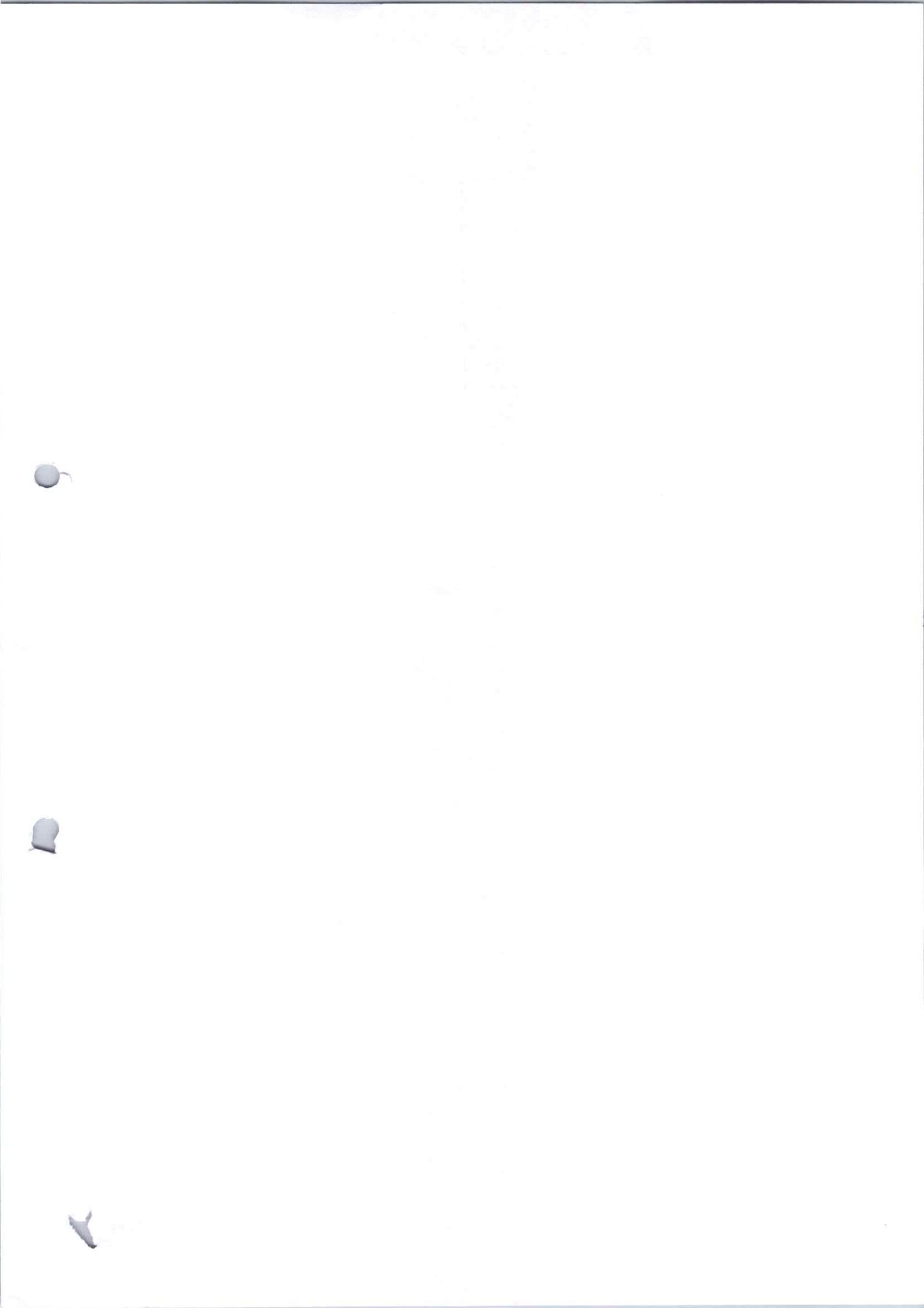

Zimbra

info@gcet.edu.in

Institute sign-up to J-HUB, JNTUH Innovation HUB - Regarding

From : JNT UNIVERSITY HYDERABAD <jhub@jntuh.ac.in> Wed, Oct 11, 2017 05:02 AM
Subject : Institute sign-up to J-HUB, JNTUH Innovation HUB - Regarding 1 attachment
To : info@gcet.edu.in, principal sphoorthy <principal.sphoorthy@gmail.com>, principal@aceec.ac.in, edcell@vnrvjiet.in, principal@nmrec.edu.in, principal@mgit.ac.in, principal@gnits.ac.in, principal@griet.ac.in, ramanareddy a <ramanareddy.a@bvrithyderabad.edu.in>

External images are not displayed. [Display images below](#)

Dear Sir/Madam

Dear Sir/Madam

Greetings of the day!

Congratulations for being part of JHub the JNTUH Innovation and Rand D initiative.

This has reference to your institute sign-up to J-HUB, JNTUH Innovation HUB.

The Events of J-Hub are starting from November/December 2017. You are therefore advised to take-up *student registration* to your institution level and prepare them through workshops through NEN and institution level Hackathons for further enablement at J-HUB on selection.

The details are enclosed in the presentation.

Any further queries may please be addressed to this email.

Yours sincerely

Dr. G. Vijayakumari
 Prof. Of CSE & Convenor JHub IAC.
 JNTUH.

Virus-free. www.avast.com

To
 Dr. Chandrakanth

PRINCIPAL
 Geethanjali College of Engg. and Tech.
 Cheeryal (V), Keesara (M), Medchal Dist.(T.S.)-501 301.

12/10/17

.....<https://docs.google.com/forms/d/e/1FAIpQLScIEST7DbQd7KHx8s4vEXkmW47Hs547FPZitmESRQc9Pyyw-RA/viewanalytics>

The screenshot shows a Google Form titled "Institute Signup Form to J-Hub". The form is for Jawaharlan Nehru Technological University Hyderabad. It includes a logo of the university and a list of identified faculty members for the I-Cell.

Institute Signup Form to J-Hub
Jawaharlan Nehru Technological University Hyderabad

* Required

Email address *
info@gbet.edu.in

Name of the Institute
Geethanjali College of Engineering and T

Faculty (2) Identified to coordinate the activities of I-Cell



PRINCIPAL
Geethanjali College of Engg. and Tech.
Cheerayal (V), Keesara (M), Medchal Dist.(T.S.)-501 301.

Faculty (2) Identified to coordinate the activities of I-Cell

Name of the Faculty Incharge 1 *

N. Chandrakanth

Contact Number *

9885723157

Email Id *

chandra.nagulapalli@gmail.com

Name of the Faculty Incharge 2 *

O.V.P.R. Sivakumar

Contact Number *

9490933019

PRINCIPAL
Geethanjali College of Engg. and Tech.
Cheeryal (V), Keesara (M), Medchal Dist.(T.S.)-501 301.

Email Id * ogirala.sivakumar@gmail.com	Name of the Student Co-ordinator 1 * N.D. Rahul
Student coordinator for I-Cell (Preferably from Excite-2017 batch)	Contact Number * 9989164141
	Email Id * rahi1996@gmail.com
	Name of the Student Co-ordinator 2 * D. Sai Jara Madhavi

PRINCIPAL
Geethanjali College of Engg. and Tech.
Cheeryal (V), Keesara (M), Medchal Dist.(T.S.)-501 301.

Name of the Student Co-ordinator 2 *

D. Sai Jaya Madhavi

Contact Number *

7702158763

Email Id *

dimkt.madhavi@gmail.com

Which of the Following Exists in Your College *

- EDC
- Incubation Centre
- Any Other Centre

Activities of the Centre

We have both EDC/NEN and center of In

PRINCIPAL
Geethanjali College of Engg. and Tech.
Cheeryal (V), Keesara (M), Medchal Dist.(T.S.)-501 301.

M J-Hub: ECE Co-ordinator X Institute Signup Form to X

Secure | https://docs.google.com/forms/d/e/1FAIpQLStEST7DpQd7KH864vEXkmW47Hs547FP2tmESRQc9Pyw-RA/viewform?c=0&w=1&includes_info_params=true

Apps Microsoft Word - DC MCQs on Sorting wit

Name of the Last held event

E-Week by EDC/NEN, Prototype develop

Date of the Event

Date 04/22/2017

Number of Participants Enrolled

Incubation Center : 110, EDC/NEN: 250

Major Outcome (Highlights of the Event)

8 Ideas for societal improvement were formulated. Students are currently working on prototypes. College app on Google was developed. Its been widely used now by students

Did your College Participate in any programmes like (Startup/Fests etc) *

Yes No

PRINCIPAL
 Geethanjali College of Engg. and Tech.
 Cheeryal (V), Keesara (M), Medchal Dist.(T.S.)-501 301.

Name of the Last held event	E-Week by EDC/NEN. Prototype develop
Date of the Event	04/22/2017
Number of Participants Enrolled	Incubation Center : 110, EDC/NEN: 250
Major Outcome (Highlights of the Event)	8 ideas for societal improvement were formulated. Students are currently working on prototypes. College app on Google was developed, its been widely used now by students
Did your College Participate in any programmes like (Startup/Fests etc) *	<input checked="" type="radio"/> Yes <input type="radio"/> No

PRINCIPAL
Geethanjali College of Engg. and Tech.
Cheeryal (V), Keesara (M), Medchal Dist.(T.S.)-501 301.

Did your College Participate in any programmes like (Startup/Fests etc) *

- Yes
- No

Any Interesting Prototypes Developed in your Institute *

STARS (SELF TRIGGERING ACCIDENT R

Signature of the principal *

Dr. Udaya Kumar Susarla

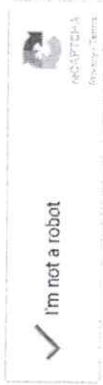

Never submit passwords through Google Forms.

F

PRINCIPAL
Geethanjali College of Engg. and Tech.
Cheeryal (V), Keeravani (M), Medchal Dist.(T.S.)-501 301.

M J-Hub: ECE Co-ordinator X Institute Signup Form to X
Secure | <https://docs.google.com/forms/d/e/1FAIpQLScESt7DbQd7KH8s4vEXkmW47H547PFZtmESRQc9Pw-RA/formResponse>
Apps Microsoft Word - DC, MCQs on Sorting wit...

Institute Signup Form to J-Hub

Your response has been recorded.

[See previous responses](#)

This form was created using Google Forms. [Create your own](#)

Google Forms

PRINCIPAL
Geethanjali College of Engg. and Tech.
Cheeryal (V), Kosterla (M), Kothchal Dist.(T.S.)-501 301.

J-Hub: ECE Co-ordinator x Institute Signup Form to x Institute Signup Form to x
 Secure | https://docs.google.com/forms/d/e/1FAIpQLSclEST7DpQd7KH8s4vEXkmW47Hs547FFZtmESRQcPpw-RA/viewanalytics
 Apps | Microsoft Word - DC MCQs on Sorting wi

Institute Signup Form to J-Hub

6 responses

Name of the Institute

6 responses

Jntuh	
IITH	
Tes11	
Jntuh ceh	
JNTUH	

Geethanjali College of Engineering and Technology

Faculty identified to coordinate the activities of I-Cell

PRINCIPAL
 Geethanjali College of Engg. and Tech.
 Cheeryal (V), Koppal (M), Medchal Dist.(T.S.)-501 301.

Faculty (2) Identified to coordinate the activities of I-Cell

Name of the Faculty Incharge 1

6 responses

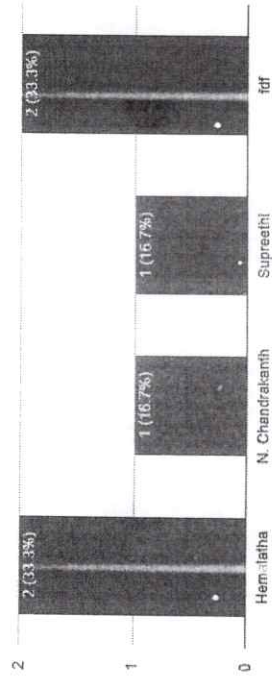

MJ-Hub: ECE Co-ordinator x Institute Signup Form to x Institute Signup Form to x
Secure | https://docs.google.com/forms/g/e/1FAIpQLSciEST7DbQd7KH8s4vEXkmW47H5s47FPZtmESRQc9Pyyv-RA/viewanalytics
Apps Microsoft Word - DC... MCCs on Sorting wit

Contact Number	
gdg	[Redacted]
fdaf	[Redacted]
99990779878	[Redacted]
9949738588	[Redacted]
94400168997	[Redacted]
9885723157	[Redacted]

Email Id	
rdg@gmail.com	[Redacted]
1dsf@gmail.com	[Redacted]
bc@gmail.com	[Redacted]
ulairk1234@gmail.com	[Redacted]

PRINCIPAL
Geethanjali College of Engg. and Tech.
Cheeryal (V), Keesara (M), Medchal Dist.(T.S.)-501 301.

Browser tabs: M JHub: ECE Co-ordinate, Institute Signup Form, Institute Signup Form, Institute Signup Form

Address bar: <https://docs.google.com/forms/d/e/1FAIpQLScIEST7DpQj7KH8s4vEXkmW47Hs547FPZtmeSRQc9Pw-RA/viewanalytics>

Page Content:

99990779878
9949798588
94400168897
9885723157

Email Id
6 responses

- gdg@gmail.com
- fdsf@gmail.com
- Abc@gmail.com
- pujarik1234@gmail.com
- vijayalode@gmail.com
- chandra.nagulapalli@gmail.com

PRINCIPAL
 Geethanjali College of Engg. and Tech.
 Cheeryal (V), Keesara (M), Medchal Dist.(T.S.)-501 301.

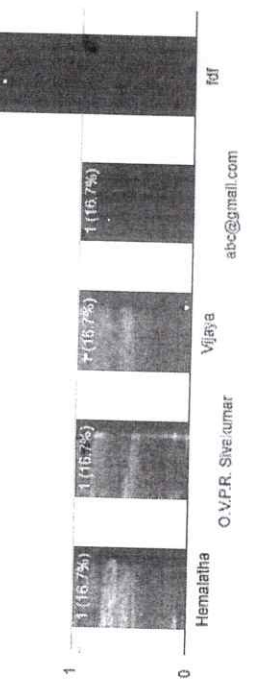
<p>Name of the Faculty Incharge 2 6 responses</p>  <table border="1"> <thead> <tr> <th>Faculty Name</th> <th>Count</th> <th>Percentage</th> </tr> </thead> <tbody> <tr> <td>Hemalatha</td> <td>1</td> <td>16.7%</td> </tr> <tr> <td>O.V.P.R. Siva kumar</td> <td>1</td> <td>16.7%</td> </tr> <tr> <td>Vijaya</td> <td>1</td> <td>16.7%</td> </tr> <tr> <td>abc@gmail.com</td> <td>1</td> <td>16.7%</td> </tr> <tr> <td>fdf</td> <td>2</td> <td>33.3%</td> </tr> </tbody> </table>	Faculty Name	Count	Percentage	Hemalatha	1	16.7%	O.V.P.R. Siva kumar	1	16.7%	Vijaya	1	16.7%	abc@gmail.com	1	16.7%	fdf	2	33.3%	<p>Contact Number 6 responses</p> <p>fdfd figfdg</p>
Faculty Name	Count	Percentage																	
Hemalatha	1	16.7%																	
O.V.P.R. Siva kumar	1	16.7%																	
Vijaya	1	16.7%																	
abc@gmail.com	1	16.7%																	
fdf	2	33.3%																	

PRINCIPAL
 Geethanjali College of Engg. and Tech.
 Cheeryal (V), Keesara (M), Medchal Dist. (T.S.) 501 101.

Id	Response
fdfd	
fgfdg	
9969987800	
98800010147	
9999900000	
9490933019	
Email Id	
fdf@gmail.com	
fdstf@gmail.com	
xyz@gmail.com	
eediheme@gmail.com	
vijyalode@gmail.com	
ogirala.sivakumar@gmail.com	

PRINCIPAL
Geethanjali College of Engg. and Tech
Cheerl (V), Keesara (M), Medchal Dist.(T.S.)-501

Student coordinator for I-Cell (Preferably from Excite-2017 batch)									
<p>Name of the Student Co-ordinator 1</p> <p>5 responses</p> <table border="1"> <tr><td>fadsfsa</td></tr> <tr><td>fdsfdf</td></tr> <tr><td>asads</td></tr> <tr><td>Ghjk</td></tr> <tr><td>Vijaya</td></tr> <tr><td>N.D. Rahul</td></tr> </table>	fadsfsa	fdsfdf	asads	Ghjk	Vijaya	N.D. Rahul	<p>Contact Number</p> <p>6 responses</p> <table border="1"> <tr><td>few87r</td></tr> <tr><td>dfd</td></tr> </table>	few87r	dfd
fadsfsa									
fdsfdf									
asads									
Ghjk									
Vijaya									
N.D. Rahul									
few87r									
dfd									

PRINCIPAL
 Geethanjali College of Engg. and Tech.
 Choeryal (V), Kamsara (M), Medchal Dist. (T.S.)-501 301.

Browser tabs: J-Hub: ECE Co-ordinator, Institute Signup Form, Institute Signup Form, Institute Signup Form

Address bar: <https://docs.google.com/forms/d/e/1FAIpQLScIEST7DbQd7KHx894vEXkmV47Hs547FP2tImESRQc8Pw-RA/viewanalytics>

Page Title: MCQs on Sorting w/ii

Contact Number	Email Id
few87r	fstfs@gmail.com
dfr	hgh@gmail.com
8889988898	bbb@gmail.com
45678885677	dfghj@gmail.com
900000090	vijayalode@gmail.com
9989164141	

PRINCIPAL

Geethanjali College of Engg. and Tech.
 Cheerai (V), Keesara (M), Medchal Dist.(T.S.)-501 301.

Name of the Student Co-ordinator 2

6 responses

fdsgf
dfjdk
aaaaaaaaaaaa
Jhgfd
Aaa
D. Sai Jaya Madhavi

Contact Number

6 responses

543td
fgbv
9090909090
9876543219
8965235426
7702158763

PRINCIPAL
Geethanjali College of Engg. and Tech.
Cheerayal (V), Keesara (M), Medchal Dist.(T.S.)-501 301.

Browser tabs: ECE Co-ordinator, Institute Signup Form, Institute Signup Form, Institute Signup Form, Institute Signup Form

Address bar: <https://docs.google.com/forms/d/e/1FAIpQLScdEST7DbQd7KHx894wEXkmV47Hs547FPZtmesRQc3Pw-RA/viewanalytics>

Page Title: Microsoft Word - EDC MCQs on Sorting with

Email Id

6 responses

- g4r53@gmail.com
- ghfs@gmail.com
- uuu@gmail.com
- Ghfljyr@gmail.com
- Vijayalode@gmail.com
- drnkt.madhavi@gmail.com

Which of the Following Exists in Your College

6 responses

Category	Percentage
EDC	50%
Incubator Centre	33.3%
Any Other Centre	16.7%

PRINCIPAL
 Geethanjali College of Engg. and Tech.
 Cleeroyal (V), Keasara (M), Medchal Dist.(T.S.)-501 301.

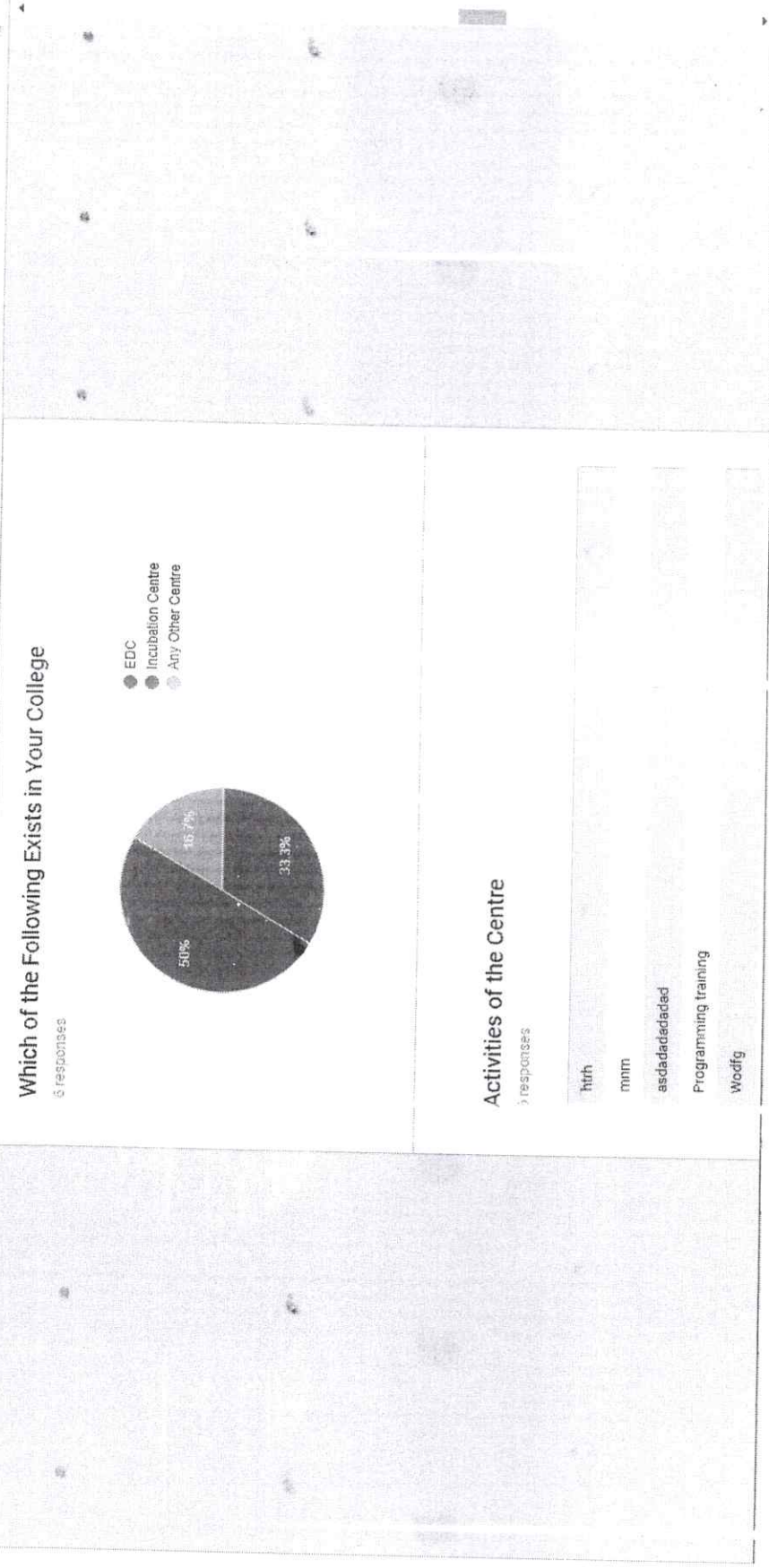

PRINCIPAL
 Geethanjali College of Engg. and Tech.
 Cheeryal (V), Koasara (M), Medchal Dist.(T.S.)-501 301.

Programming training

Woodfg

We have both EDC/NEN and center of innovation (incubation center) at our institute. We Conduct Technical workshops, entrepreneur week (e-Week), awareness camps etc for interdisciplinary teams. The incubation center encourages students to work on ideas and prototypes. Currently 6 interdisciplinary teams are working on various projects.

Name of the Last held event

6 responses

yby

mmm

aaaaaaaaaaaaaaaa

Finishing school

Aaaa

E-Week by EDC/NEN, Prototype development by Incubation center. In addition, 3 teams participated in EXCITE program, one of which is part of the 10 selected

PRINCIPAL
 Geethanjali College of Engg. and Tech.
 Cheeryal (V), Keerasa (M), Medchal Dist.(T.S.)-501 301.

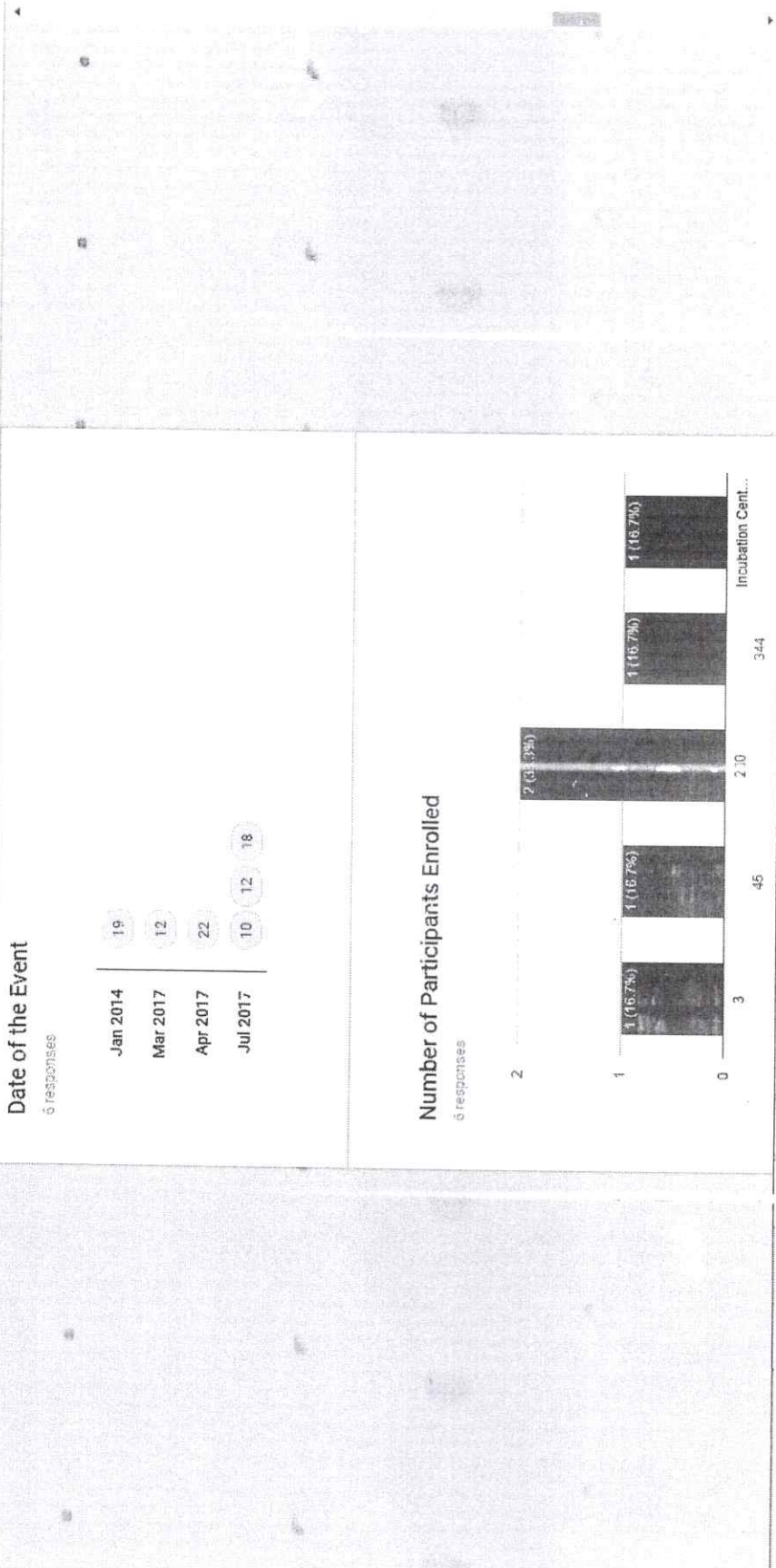

PRINCIPAL
 Geethanjali College of Engg. and Tech.
 Cheerla (V), Keesara (M), Medchal Dist.(T.S.)-504 301.

Major Outcome (Highlights of the Event)

6 responses

ggfrs
 mnvm
 mmmmmmmmmmmmmmmmm
 Employability
 Asdf

8 ideas for societal improvement were formulated. Students are currently working on prototypes. College app on Google was developed its been widely used now by students

Did your College Participate in any programmes like (Startup/Fests etc)

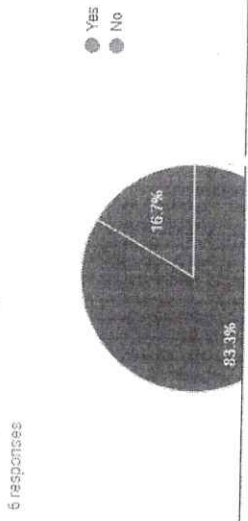

PRINCIPAL
 Geethanjali College of Engg. and Tech.
 Cheeryl (V), Keesara (M), Medchal Dist.(T.S.)-501 301.

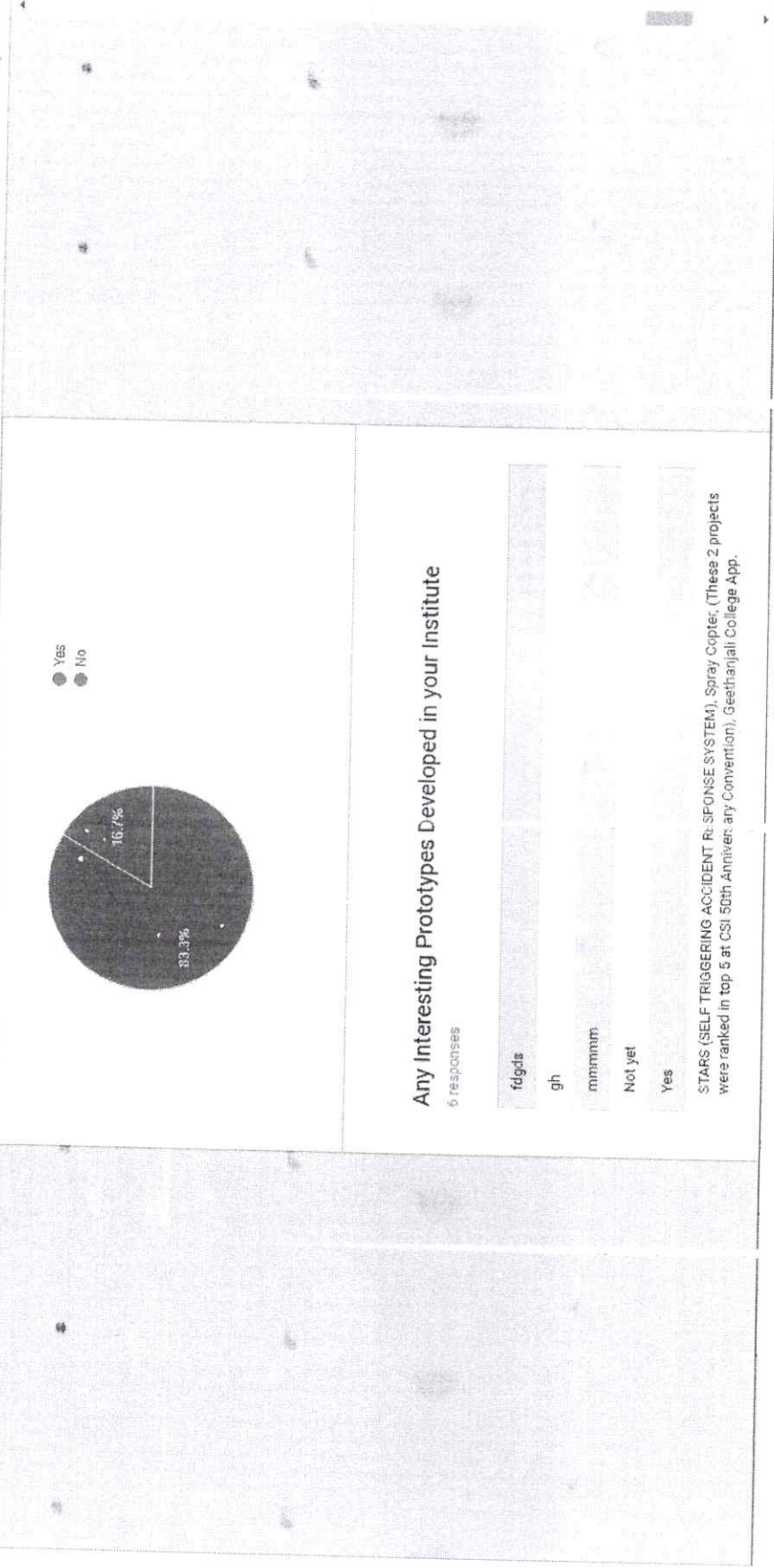

PRINCIPAL
 Geethanjali College of Engg. and Tech.
 Cheerl (V), Keesara (M), Medchal Dist.(T.S.)-501 301.

<p>Signature of the principal 5 responses</p> <table border="1"><tr><td>kjk</td></tr><tr><td>bb</td></tr><tr><td>Supreethi</td></tr><tr><td>Asa</td></tr><tr><td>Dr. Udaya Kumar Susarla</td></tr></table>	kjk	bb	Supreethi	Asa	Dr. Udaya Kumar Susarla	<p>Number of daily responses</p> <table border="1"><caption>Data for Number of daily responses</caption><thead><tr><th>Day</th><th>Number of responses</th></tr></thead><tbody><tr><td>1</td><td>1</td></tr><tr><td>2</td><td>2</td></tr><tr><td>3</td><td>3</td></tr><tr><td>4</td><td>4</td></tr><tr><td>5</td><td>5</td></tr><tr><td>6</td><td>6</td></tr></tbody></table>	Day	Number of responses	1	1	2	2	3	3	4	4	5	5	6	6
kjk																				
bb																				
Supreethi																				
Asa																				
Dr. Udaya Kumar Susarla																				
Day	Number of responses																			
1	1																			
2	2																			
3	3																			
4	4																			
5	5																			
6	6																			

PRINCIPAL
Geethanjali College of Engg. and Tech.
Cheeryal (V), Keesara (M), Medchal Dist.(T.S.)-501 301.

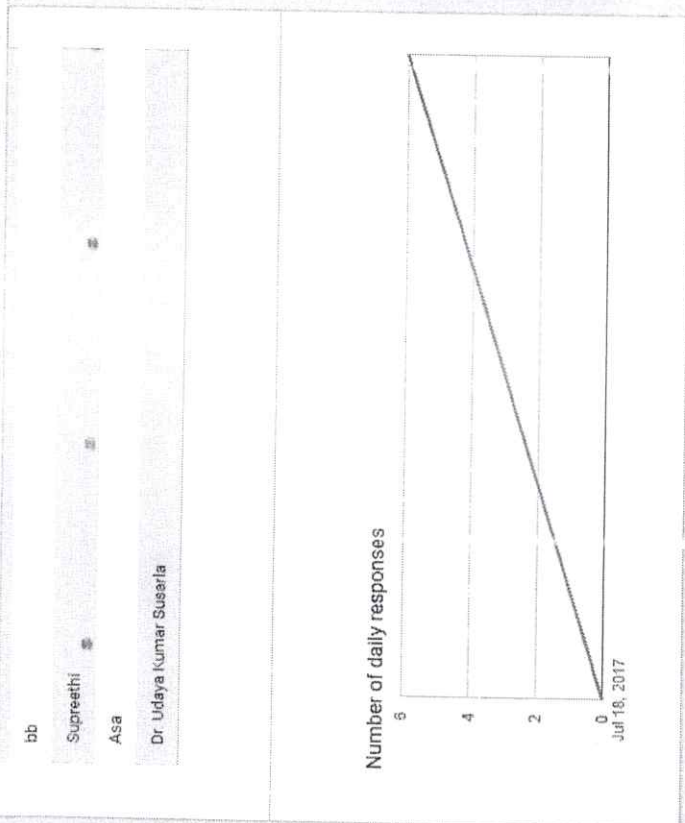

This content is neither created nor endorsed by Google. Report Abuse - Terms of Service - Additional Terms

Google Forms

PRINCIPAL
Geethanjali College of Engg. and Tech.
Cheerayal (V), Keasara (M), Medchal Dist. (T.S.)-501 301.

Chat History JHUB - SPOC

2/17/18, 19:35 - Messages to this group are now secured with end-to-end encryption. Tap for more info.
 2/17/18, 15:42 - +91 99080 13310 added created group "JHUB-SPOC-2018"
 2/17/18, 19:35 - +91 99080 13310 added added you
 2/17/18, 19:35 - +91 99080 13310 added added +91 94410 08127 and +91 99597 01905
 2/17/18, 19:35 - +91 98490 92378 left
 2/17/18, 19:35 - +91 99080 13310 added added +91 90004 44578 and +91 96528 82100
 2/17/18, 19:35 - +91 99080 13310 added added +91 98857 63371
 2/17/18, 19:35 - +91 99080 13310 added added +91 93906 38524, +91 98485 32799, and +91 98496 12432
 2/17/18, 19:35 - +91 99080 13310 added added +91 80081 11014, +91 98495 54882, and +91 99596 13556
 2/17/18, 19:35 - +91 99080 13310 added added +91 92465 45486, +91 94404 18374, and +91 98495 24535
 2/17/18, 19:35 - +91 99080 13310 added added +91 99453 99533
 2/17/18, 19:35 - +91 99080 13310 added added +91 98668 53636 and +91 99497 38588
 2/17/18, 19:35 - +91 99080 13310 added added +91 92461 73939, +91 94409 36885, and +91 94913 39692
 2/17/18, 19:35 - +91 99080 13310 added added +91 94406 88833 and +91 98484 35073
 2/17/18, 19:35 - +91 99080 13310 added added +91 98663 01801
 2/17/18, 19:35 - +91 99080 13310 added added +91 99088 53084
 2/17/18, 19:35 - +91 99080 13310 added added +91 99443 08058
 2/17/18, 19:35 - +91 99080 13310 removed +91 98484 35073
 2/17/18, 19:35 - +91 98663 01801 left
 2/17/18, 19:35 - +91 99080 13310 added added +91 98663 01501
 2/17/18, 16:15 - +91 99597 01905: Thank you Hema!
 2/17/18, 16:16 - +91 99597 01905: Put the shortlisted teams list in the group
 2/17/18, 16:16 - +91 99080 13310: Dear Group members
 Welcome to the group. This group is for further communication regarding Jhub and Jcell Activities.
 2/17/18, 16:17 - +91 99596 13556: Waiting for this message
 2/17/18, 16:17 - +91 98495 54882: Please add Dr Madan from our college
 +91 99443 08058
 2/17/18, 16:17 - +91 80081 11014: Thank you.
 2/17/18, 16:17 - +91 98495 54882: Thank you very much for adding
 2/17/18, 16:18 - +91 98495 54882: Dr Padmaja, Principal, VJIT
 2/17/18, 16:18 - Udaya Kumar Sir Gcet: Thank you for adding me to the group
 Regards
 Principal of Geethanjali College of Engineering and Technology
 2/17/18, 16:19 - Chandrakanth Sir.gcet: Thank you for the invitation Ma'am, this is Prof Chandrakanth from geethanjali
 2/17/18, 16:21 - +91 99080 13310: <Media omitted>
 2/17/18, 16:22 - +91 99080 13310: Dear All
 Please find the attached file regarding short listed teams for Boot Camp and Hackathon.
 2/17/18, 16:24 - +91 99080 13310: Congratulations to the Teams. You are hereby informed to come for Boot camp
 scheduled on 19th and 20th, February 2018 at First Floor, Jhub Office, New Admissions Block, JNTUH.
 2/17/18, 16:25 - +91 99080 13310: Requesting SPOCS to please share the above information to the students who selected
 for Boot camp.
 2/17/18, 16:30 - +91 99597 01905: Pls be informed that teams not in the shortlist would have another program wherein
 their ideas will be mentored for further refinement. The exact dates will be informed in due time. Look forward to see you all at
 JHub. Request the SPOCs to communicate the same to the registered teams.
 2/17/18, 16:37 - +91 99481 25929: Thank you Madam.
 2/17/18, 16:37 - +91 99481 25929: S.KannaRao, ACE Engg College..
 2/17/18, 16:38 - Harish EEE Gcet: Thank you madam for the invitation
 Dr. Harish pulluri
 From Geethanjali college of engineering and technology
 2/17/18, 17:22 - Siva Kumar Ovpr: Thank you ma'am. I am Prof.Sivakumar from Geethanjali College of Engineering and
 Technology
 2/17/18, 17:27 - +91 90109 63013: What will be agenda and content of this camp madam?
 2/17/18, 17:27 - +91 90109 63013: Thank u madam for adding....
 Maruti,KITS
 2/17/18, 17:30 - +91 87900 18470: Thank you madam, I am Dr.Sreevani from MGIT
 2/17/18, 17:35 - +91 90306 80515: Thank you madam for adding Rajitha Ace engg college
 2/17/18, 18:05 - +91 98663 01501: I didn't receive any message madam
 2/17/18, 18:07 - +91 99088 53084: ðŸ˜ˆ
 2/17/18, 18:24 - +91 97011 84442: Thank u Hema Latha madam for adding us..
 From GNITS

PRINCIPAL
 Geethanjali College of Engg. and Tech.
 Cheral (G), Krasara (M), Andchal Dist (T.S.)-501 303.

SEARCHING FOR SPORTS HEADLINES AND SCORES

- â- CBS SportsLine (www.sportsline.com)
- â- CNN/Sports Illustrated (sportsillustrated.cnn.com)
- â- ESPN.com (espn.go.com)
- â- FOXSports (foxsports.lycos.com)
- â- NBC Sports (www.nbcsports.com)
- â- The Sporting News (www.sportingnews.com)

SEARCHING FOR MEDICAL INFORMATION

- â- healthAtoZ.com (www.healthatoz.com)
- â- kidsDoctor (www.kidsdoctor.com)
- â- MedExplorer (www.medexplorer.com)
- â- MedicineNet (www.medicinenet.com)
- â- National Library of Medicine (www.nlm.nih.gov)
- â- Planet Wellness (www.planetwellness.com)
- â- WebMD Health (my.webmd.com)

JOURNALS

- <http://www.indexcopernicus.com> Multidisciplinary
- <http://www.ajol.info/> - African Journal Online
- www.africanjournalseries.com -
- www.devconsortservices.com.ng
- www.doaj.org - directory of open access journal
- www.sabinet.co.za - South African Journals.
- www.oajse.com - Open Access Journal Search Engine
- <http://www.lub.lu.se/en.html> - Lund University
- <http://www.dovepress.com/> - Free Scientific & Medical Materials
- <http://www.copernicus.org/> - Access & Publication

ACADEMIC SEARCH/WEB RESEARCH TOOLS/REFERENCE MANAGERS

- <http://academic.research.microsoft.com> - Multidisciplinary
- <http://www.scirus.com>
- www.scholar.google.com
- <http://dbis.uni-trier.de/DBL-Browser/> - Digital Bibliography Library Browser
- <http://academic.live.com> - Live Search Academic
- <http://www.science.gov/> - USA government for Science
- <http://citeserx.ist.psu.edu/index> - Computing & Information Sciences
- <http://www.mendeley.com/> - academic social network/collaboration
- <http://www.worldcat.org/> - Multidisciplinary
- <http://libserver.cedefop.europa.eu> - Voc & Tech Education
- <http://inspirehep.net/> - Stanford physics information retrieval system
- hsystemvÂ www.ssrn.com/ - Social Science Research Network. M.Ravichandran.VKR PHARMA KRISHNAGIRI
- 2/22/18, 17:02 - â€+91 99597 01905â€-: Heads Up for the Hackathon on CYBER PHYSICAL SYTEMS and INDUSTRY 4.0 at JHub scheduled tomorrow.
- 2/22/18, 17:03 - â€+91 99597 01905â€-: All teams in List1 and List 2 are required to report at 9am at JHUB 1st floor admission block JNTUH campus
- 2/22/18, 17:04 - â€+91 99597 01905â€-: The Hackathon is 36hrs overnight and the valedictory is scheduled at 4pm on 24th Feb Sarurday.
- 2/22/18, 17:06 - â€+91 99597 01905â€-: The SPoCs are requested to ensure the teams are reporting with the required laptops/hardware/sensors etc required for their prototypes.
- 2/22/18, 17:08 - â€+91 99597 01905â€-: The SPoCs, any interested parents are welcome to give any moral support during the overnight hackathon.
- 2/22/18, 17:09 - â€+91 99597 01905â€-: Wishing all the teams a rewarding experience at the HACKATHON !
- 2/26/18, 17:56 - â€+91 99597 01905â€- added â€+91 94901 41230â€-
- 2/26/18, 13:00 - â€+91 99080 13310â€-: Dear Sir/Madam.
- The second meeting of the Institution Coordinators is scheduled on March 3rd, 2018 at 10:30am at JHUB , 1st floor Admission block JNTUH campus.

PRINCIPAL
Geethanjali College of Engg. and Tech.
Cheeryal (V), Keesara (M), Madhchal Dist.(T.S.)-501 301.

3/8/18, 19:26 - +91 93906 38524: Hey guys.....ready to take up the biggest hackathon of the planet ??.. Here's the chance to prove yourself. NASA representative SUVMN is conducting the NASA space Apps challenge at SNIST this March on 15th & 16th. The hackathon is as follows

PHASE 1

Hackathon @College/School
College/School conducted Hackathon/Space Fair
Themes were given by organizing team
Nomination of top three teams from each College/School

PHASE 2

Hackathon @ T-Hub
Centralized Hackathon for all winning teams from College/School
Challenges were given by NASA
Top teams to be nominated to NASA

PHASE 3

NASA Space Accelerator
NASA to take a call on all top teams across the world and select Winners
Global Recognition
NASA Space App Accelerator

BENEFITS

Opportunity to nominate three teams for central hackathon
NASA Student Certificate to all participants
NASA Certificate to Host College
NASA Zonal Winner Certificate to the college winners

So gear up and let us hear from you

Register at <https://goo.gl/forms/dYh7Kcp395CXX3ef1>

For any details contact:

Pallavi - +91 95336 06174

Kiran - +91 9000723387

Gaurav - +91 7702195915

3/8/18, 19:26 - +91 93906 38524: <Media omitted>

3/9/18, 16:52 - +91 94901 41230: <Media omitted>

3/9/18, 16:52 - +91 94901 41230: The following list is being updating in the web site. Please notify any changes.

3/9/18, 17:02 - +91 90101 80199: Srinivas ji, Pls update my name...

Dr. Y.J.Nagendra Kumar

Professor

GRIET

3/9/18, 17:03 - +91 94901 41230: Ok

3/9/18, 17:36 - +91 94913 39692: Update my name as Dr. P. Swetha, email id : swetha.perumalla1@gmail.com

3/9/18, 17:37 - +91 94913 39692: Update my name as Dr. P. Swetha, email id : swetha.perumalla1@gmail.com from JNTUHCEJ

3/9/18, 17:37 - +91 94901 41230: Ok madam

3/12/18, 12:21 - +91 99480 49293: <Media omitted>

3/12/18, 13:52 - +91 99597 01905: Dear All , Hope students are able to register and send ideas to Aspiring Women Entrepreneurs program with IC2 institute , University of Texas. Last date in 16th March. Pl encourage students to apply. They will get many opportunities to connect to experts in addition to the summer internship.

3/12/18, 13:52 - +91 99497 38588: OK madam

3/12/18, 14:00 - +91 94404 48924: Madam definitely convey the information to students.

3/13/18, 10:21 - +91 96768 67222: For the Under Graduate Summit

Sphoorthy Engineering College got nominated for 3 Awards

1) Best Emerging College

2) Best participation in the Events

3) Best Academic Performer

PRINCIPAL
Geethanjali College of Engg. and Tech.
Cheeraj (V), Keesara (M), Medchal Dist.(T.S.)-501 201.
6

3/16/18, 10:54 - 92465 60870: Good morning. On March 16,17 we have College Tech Fest and Annual Day on March 17.

3/16/18, 10:54 - 92465 60870: So I may not be able to participate this time Sir.Thank you.

3/16/18, 12:14 - 92465 45486: <Media omitted>

3/16/18, 12:14 - 92465 45486: <Media omitted>

3/16/18, 13:37 - 94901 41230: Please update activities conducted in J-Labs / Innovations under the Innovation tab of Stumagz by 25th March 2018. The magazine of J-Hub is being prepared and the events conducted in J-Lab suitably promoted to J-Hub.

3/16/18, 13:52 - 92465 45486: Ok

3/17/18, 08:27 - 92465 45486: Good morning. On March 21,22 we have NAAC visit So I am unable to participate this time madam.Thank you.VBIT

3/17/18, 08:32 - 92465 45486: After meeting finalized points and necessary information share to spoc mails id if possible Arun.G, spoc,VBIT

3/17/18, 13:10 - 99597 01905: Dr A Sreenivasa Rao sreenivasarao_a@vnrvjiet.in

3/17/18, 13:13 - 99597 01905: Sreenivas pl make the correction

3/17/18, 13:13 - 94901 41230: Om madam

3/17/18, 13:13 - 94901 41230: Ok mam

3/18/18, 10:49 - 99666 72730: <Media omitted>

3/18/18, 14:06 - 99443 08058: 's security code changed. Tap for more info.

3/23/18, 12:37 - 99597 01905: added 90307 51024

3/24/18, 11:57 - 94901 41230: Dear All,
Pl find enclosed the JHub logo options of two sets with four options each. Send your votes by typing set number and option number.

3/24/18, 11:57 - 94901 41230: <Media omitted>

3/24/18, 11:57 - 94901 41230: <Media omitted>

3/24/18, 11:58 - 90101 80199: Set 2 option 4

3/24/18, 12:18 - 81798 27400: Yes

3/24/18, 12:21 - 99497 38588: Set 1 option1

3/24/18, 12:21 - 94410 08127: Set2 option1

3/24/18, 12:21 - 94410 08127: ðŸ˜†

3/24/18, 12:23 - 94404 48924: Set 2 option 2 will be better from our end.

3/24/18, 12:23 - 93906 38524: ðŸ˜†

3/24/18, 12:28 - 99595 59905: Set 2 option 1

3/24/18, 12:30 - 98496 12432: This message was deleted

3/24/18, 12:32 - 94913 39692: Set 2 option 1

3/24/18, 12:40 - 92465 45486: Set 2 option 1

3/24/18, 12:40 - 90307 51024: Set 2 Option 4

3/24/18, 12:57 - 98494 07965: Set 1 option 3

3/24/18, 15:41 - 92465 60870: set 2 option 1

3/24/18, 16:41 - 90306 80515: Set 2 option 1

3/24/18, 16:44 - 98850 16061: Set 2 option 2

3/24/18, 17:21 - 98495 54882: Set 1 Option 1

3/24/18, 17:22 - Harish EEE Gcet: Set 2 option 4

3/24/18, 18:38 - 87900 18470: Set 2 option 1

3/24/18, 18:47 - 80889 77999: Set 2 option 4

3/24/18, 18:54 - 98668 12121: Set 2 option 4

3/24/18, 18:59 - 89770 32055: Set 1 option 3

3/24/18, 20:08 - 99080 13310: Set 2 option 2. ðŸ˜†

3/26/18, 07:32 - 87900 18470: ðŸ˜†

3/26/18, 07:35 - Udaya Kumar Sir Gcet: <Media omitted>

3/26/18, 07:37 - 92465 45486: Don't forwarded msgs plzz

3/26/18, 07:37 - 92465 45486: ðŸ™ ðŸ »

3/26/18, 07:47 - Udaya Kumar Sir Gcet: Sorry for disturbing you, I would ensure it

3/26/18, 09:17 - 99088 53084: <Media omitted>

3/26/18, 09:20 - 90307 51024: Let's all celebrate our festivals like in the days before WhatsApp, without sharing pictures that clutter cyberspace or clog our mobile storage space! ðŸ˜†

4/4/18, 21:44 - â€³+91 99088 53084â€³: ðŸˆ¸
4/4/18, 21:44 - â€³+91 99088 53084â€³: Congratulations Madam
4/4/18, 22:00 - â€³+91 91603 29739â€³: Sir can u share the website address
Sorry iam not finding it in Google
4/4/18, 22:02 - â€³+91 94901 41230â€³: www.jhub.ac.in
4/4/18, 22:03 - â€³+91 91603 29739â€³: Thank you sir
4/6/18, 15:00 - â€³+91 92465 60870â€³: Good afternoon. can you please add the following members to the group.
4/6/18, 15:00 - â€³+91 92465 60870â€³: Mr Narendersingh Singh
9014067636
Dr Sudheer Reddy
9160017017
4/6/18, 15:00 - â€³+91 92465 60870â€³: 2 faculty will come from Anurag Group mam
4/6/18, 15:01 - â€³+91 99480 49293â€³: I will be attending mam from GRIET

Pradeep Reddy G
4/6/18, 15:01 - â€³+91 94938 65036â€³: Good Afternoon Madam. One faculty will be coming from Sphoorthy Engineering College.
4/6/18, 15:03 - â€³+91 81798 27400â€³: 3 Faculty will be coming from BVRIT HYDERABAD mam.
4/6/18, 15:08 - â€³+91 99595 59905â€³: Good afternoon

Kindly add the following number to the group

Dr M Sreevani
8790018470
MGIT

4/6/18, 15:54 - â€³+91 93906 38524â€³: Myself and Mr.Dheeraj will be joining for the meeting.
Dr. Ameet Chavan
4/6/18, 16:16 - â€³+91 98495 54882â€³: From VJIT M Goutham would be attending
4/6/18, 16:17 - â€³+91 98490 24369â€³: Two faculty from Nalla Malla Reddy Engineering College
4/6/18, 16:38 - â€³+91 92465 45486â€³: This message was deleted
4/6/18, 16:51 - â€³+91 92465 45486â€³: Two faculty from VBIT
4/6/18, 17:11 - â€³+91 90307 51024â€³: Two faculty members from VNRVJIET
4/7/18, 14:24 - â€³+91 94901 41230â€³ added â€³+91 97054 49268â€³
4/7/18, 14:25 - â€³+91 94901 41230â€³ added â€³+91 98663 01501â€³
4/7/18, 12:45 - â€³+91 94901 41230â€³: <Media omitted>
4/7/18, 12:46 - â€³+91 99088 53084â€³: <Media omitted>
4/7/18, 12:46 - â€³+91 99088 53084â€³: <Media omitted>
4/7/18, 12:46 - â€³+91 99088 53084â€³: <Media omitted>
4/7/18, 15:21 - â€³+91 98495 24535â€³'s security code changed. Tap for more info.
4/7/18, 16:08 - â€³+91 99590 05038â€³ changed to +91 77801 17200
4/8/18, 18:16 - â€³+91 94938 65036â€³: Madam, please share the slides of Saturday's meeting.
4/8/18, 18:16 - â€³+91 94938 65036â€³: shwetamanghnani14@gmail.com
4/8/18, 18:35 - â€³+91 91603 29739â€³: @919490141230 sir plz keep our jhub logo as DP
4/8/18, 20:03 - â€³+91 99597 01905â€³ changed this group's icon
4/9/18, 16:41 - â€³+91 98495 24535â€³'s security code changed. Tap for more info.
4/9/18, 21:29 - â€³+91 98495 24535â€³'s security code changed. Tap for more info.
4/10/18, 09:59 - â€³+91 99666 72730â€³: Any updates on coming events like boot camp, exite
4/10/18, 10:10 - â€³+91 99597 01905â€³: Registrations will open today. Will send you the link once it is putup
4/10/18, 10:31 - â€³+91 99666 72730â€³: Ok madam
4/10/18, 12:56 - â€³+91 94938 65036â€³'s security code changed. Tap for more info.
4/10/18, 17:14 - â€³+91 94901 41230â€³ changed this group's icon
4/10/18, 17:10 - â€³+91 94901 41230â€³: Registrations for summer programmes is open. Please refer your mail for details.
Registrations can be done from the website www.jhub.ac.in
4/11/18, 16:05 - â€³+91 81798 27400â€³: Anwar Pasha BVRITH.vcf (file attached)
4/11/18, 16:05 - â€³+91 81798 27400â€³: @919490141230 sor, pl add Anwar Sir, He is our college EDC cell Incharge
4/11/18, 16:05 - â€³+91 81798 27400â€³: *sir
4/12/18, 13:03 - â€³+91 94901 41230â€³ added â€³+91 94402 15230â€³
4/12/18, 13:13 - â€³+91 94901 41230â€³ added â€³+91 97013 52066â€³
4/12/18, 12:40 - â€³+91 94901 41230â€³: Applications for Startup Accelerator can be made at www.jhub.ac.in. The programme is meant for students passing out June 2018
4/12/18, 15:45 - â€³+91 80081 11014â€³: Dear Mr. Srinu, I have not received any mail regarding registration.

4/26/18, 13:56 - â€+91 99088 53084â€: Okay Madam, good decision
4/27/18, 12:49 - â€+91 90307 51024â€: Who all are attending this session today? I'm here.
4/27/18, 13:44 - â€+91 99666 72730â€: <Media omitted>
4/28/18, 20:01 - â€+91 80081 11014â€: *Workplace rules for happy life:*

1. *Trust no one* but respect everyone.
2. What happens in office, remain office. *Never take office gossips* to home and vice versa.
3. *Enter office on time, leave on time*. Your desktop is not helping to improve your health.
4. *Never make Relationships* in the work place. It will always backfire.
5. *Expect nothing*. If somebody helps, feel thankful. If not, you will learn to know things on your own.
6. *Never rush for a position*. If you get promoted, congrats. If not, it doesn't matter. You will always be remembered for your knowledge and politeness, not for your designation.
7. *Never run behind office stuff*. You have better things to do in life.
8. *Avoid taking everything* on your ego. Your salary matters. You are being paid. Use your assets to get happiness.
9. It *doesn't matter how people treat you*. Be humble. You are not everyone's cup of tea.
10. In the end *nothing matters except family*, friends, home, and Inner peace.

World's Mental health day theme by WHO.
Mental Health at work place

<http://www.who.int/>

mental_health/world-mental-health-day/2017/en/

4/30/18, 18:20 - â€+91 90307 51024â€-'s security code changed. Tap for more info.

4/30/18, 23:15 - â€+91 98666 19887â€-'s security code changed. Tap for more info.

5/2/18, 12:31 - â€+91 99597 01905â€: Hello everyone. The SPoC meeting of May 2018 is scheduled on 5th May Saturday at 11am. Kindly make it convenient to attend the same. A line of confirmation is highly solicited.

5/2/18, 12:34 - â€+91 99597 01905â€: The Agenda of the meeting is as follows

1. Schedule of Summer Programs.
2. Orientation on Pre-workshop assignments.
3. How to evaluate and mentor ideas.

5/2/18, 20:38 - Chandrakanth Sir.gcet: Ma'am one SPOC from Geethanjali will attend the meeting

5/2/18, 21:00 - â€+91 99597 01905â€: Ok. Hope he knows the ideas submitted by the students.

5/2/18, 21:45 - â€+91 94938 65036â€: Please add Manjunath Kempar of Sphoorthy Engineering College in the group. Thankyou.

5/2/18, 21:45 - â€+91 94938 65036â€: Manju Kempar Sphn.vcf (file attached)

5/3/18, 00:15 - â€+91 92461 73939â€ left

5/3/18, 08:48 - â€+91 98850 16061â€: 'ðŸ', 'ðŸ', 'ðŸ', 'ðŸ' -

5/3/18, 11:05 - â€+91 94901 41230â€: Dear all, please indicate the number of coordinators attending the meeting so as to make lunch and other logistics arrangements.

5/3/18, 11:12 - â€+91 98492 75094â€: Dear strenu

5/3/18, 11:15 - â€+91 98492 75094â€: Dear sreenu one SPOC is going to attend from ACE Engineering college

5/3/18, 11:17 - â€+91 94402 15230â€: Two members from BVRITH

5/3/18, 12:17 - â€+91 90101 80199â€: 1 from GRIET

5/3/18, 13:07 - â€+91 92465 45486â€: 2 members from VBIT

5/3/18, 13:12 - â€+91 80081 11014â€: 2 members from VJIT

5/3/18, 13:13 - â€+91 98490 24369â€: Two Members from Nalla Malla Reddy Engineering College(NMREC)

5/3/18, 14:26 - â€+91 93906 38524â€: Two faculty from snist will be attending

5/3/18, 15:33 - â€+91 94938 65036â€: One faculty from Sphoorthy Engineering College.

5/3/18, 15:36 - â€+91 99595 59905â€: One from MGIT

5/3/18, 15:50 - â€+91 99666 72730â€: Dear Madam, one from GNITS.

5/3/18, 18:41 - â€+91 90307 51024â€: I'll be the only one attending from VNRVJIET, ma'am

5/3/18, 22:44 - â€+91 98666 19887â€-'s security code changed. Tap for more info.

Geethanjali College of Engg. and Tech.
Cheeraj (M), Keesara (M), Medchal Dist., (T.S.)-501 301.

Based on the requests from the institutions the application for Startup Accelerator is open. Screening committee is expected to be held during last week of May, 2018. You are requested to send any application latest by 25.05.2018 to participate in the screening.

Visit: www.jhub.ac.in

5/14/18, 15:14 - â€+91 94913 39692â€-: EXCITE. 17.05.2018 TO 30.06.2018
BOOTCAMP. 28.05.2018 TO 08.06.2018

IGNITE. JUNE 21,22,23, 2018

5/16/18, 10:38 - â€+91 99481 25929â€-: Dear Madam, Good Morning.Can you inform about Tomorrow's EXCITE program Venue.

5/16/18, 10:56 - â€+91 94901 41230â€-: EXCITE programme venue: J-HUB, JNTUH

5/16/18, 11:32 - â€+91 94901 41230â€-: Dear All,

The EXCITE 2018 programme is scheduled from 17.05.2018 to 30.06.2018. All the students who have registered and submitted assignments are required to report at 10.00 a.m. in J-HUB, JNTUH. The assignments will be reviewed by the panel and finalization of ideas to be taken up will be curated by experts. Formal inauguration is being planned after the finalization of ideas.

The SPoCs are advised to encourage the students and provide advices from time to time. They are welcome for the entire workshop to track the progress of the teams.

5/16/18, 11:57 - â€+91 98486 22979â€-: Dear madam this is Praveen from VJIT. as already I informed about our students that they have exams till 23rd may and they will join from 24th may

Thank you

5/17/18, 19:38 - â€+91 90307 51024â€-: Please share the link to the Google Drive for EXCITE assignments.

5/17/18, 21:31 - â€+91 98492 75094â€-: Kindly provide Google link. Students are asking about link

5/17/18, 22:15 - â€+91 99597 01905â€-: https://drive.google.com/drive/folders/1VTn1j008-mysUTsqo_LqJduWiBE8b_H1?usp=sharing

5/20/18, 08:23 - â€+91 99597 01905â€-: <Media omitted>

5/20/18, 08:30 - â€+91 99597 01905â€-: Good morning everyone. As the ViceChancellor Sir is busy we have blocked his time for formal inaugural of EXCITE 2018 on Tuesday morning. Pl block your calender for attending the Inaugural session on 22nd May in the morning. The exact time and Agenda will be sent tomorrow.

5/20/18, 11:29 - â€+91 99080 13310â€-: ðŸˆ¸

5/20/18, 11:54 - â€+91 90307 51024â€-: Great! Thank you for the information, ma'am.

5/20/18, 12:54 - â€+91 94404 48924â€-: Thank you for the invitation madam. Will be antcipating for schedule.

5/21/18, 12:04 - â€+91 99597 01905â€-: Good morning everyone. As you are all kindly aware that the ideas submitted by the student teams are being curated by mentors thru pre-workshop assignmnets and the students have finalized on their ideas and exploring technologies for implementation.

5/21/18, 12:14 - â€+91 99597 01905â€-: In this connection I request you all to kindly join for the Inaugural Function of the EXCITE 2018 workshop tomorrow the 22nd May 2018 at 10:30am in the UGC-HRDC Auditorium JNTUH.

Hon'ble Vice -Chancellor JNTUH has consented to be Chief Guest of the function.

5/21/18, 12:16 - â€+91 99597 01905â€-: Rector JNTUH, Registrar JNTUH and Steering committee will be other key speakers on the occasion.

5/22/18, 11:43 - â€+91 99666 72730â€-: Q : What is Nipah Virus ?

A : Nipah virus was initially discovered when it caused an outbreak of brain fever among pig farmers in Malaysia.

Q : Should I be worried ?

A : A little. As it is transmitted from person to person and there is no effective antiviral therapy for this infection .

Q : Who is at high risk ? How is it transmitted ?

A : 1. People working with pigs and consuming pigs.

2. Farmers who come in contact with bats.

3. Consuming Fruits-which are already bitten by bat.

4. Contact with people who already have Nipah virus infection.

Q : What are the early symptoms ?

GEETHANJALI COLLEGE OF ENGINEERING AND TECHNOLOGY

IGNITE STUDENT LIST

S.No	Name	Roll No	Branch	Phone	Email
1	Jyotishwara Prasad A	17R11A05G4	CSE	9705632126	ajyotish2000@gmail.com
2	M Gokul	17R11A0562	CSE	9704704112	mamandurugokul1@gmail.com
3	Aditya Sharma	1711A05H4	CSE	8639569330	
4	A Sankeerthana	17R11A0451	ECE B	9550306560	sankeerthanaaria@gmail.com
5	Rohit Vishal	17R11A0462	ECE B		
6	P. Uday Sai	17R11A0289	EEE B	9182338865	pillalamarriuday@gmail.com

PRINCIPAL
 Geethanjali College of Engg. and Tech.
 Cheryal (V), Keesara (M), Medchal Dist.(T.S.)-501 301.

IGNITE WORKSHOP for 1 year B.Tech students

A 3 day intensive workshop on Innovation to inspire 1 year B.Tech students in J-Labs is scheduled during 3rd week of May 2018. One team from each J-Lab shall be nominated of size 3.

* Required

Name of the Team Member_1 *

Jyotishwara Prasad.A

Contact Number *

9705632136

Email Id *

ajyotish2000@gmail.com

Name of the Team Member_2 *

M.Gokul

Contact Number *

9704704112

Email Id *

mamandurugokul1@gmail.com

Name of the Team Member_3 *



Aditya Sharma

Contact Number *

8639567930

Email Id *

PRINCIPAL
Geethanjali College of Engg. and Tech.
Cheerayal (V), Narsara (R), Anaparthi Dist./T.S.-501 301.





i-Cell
@
Geethanjali College of Engineering and Technology

Contents

- **Incubation Activities**
 - Regular Activities
 - Activities this year
- **EDC Activities**
 - Activities

EXCITE @ JNTU-Hyderabad

- We have been actively participating in the EXCITE program conducted by JNTUH for last 3 years
- We have started i-cell in line with JHUB



Cylimon Project worked on at EXCITE - 2017

Incubation Activities – Regular

- Regular classes for 2nd and 3rd year interested students
- Workshops conducted regularly
 - Arduino Uno with sensors
 - Raspberry PI with sensors
 - Android in association with NSIC

Conducted free of cost
- Hackathon
 - Currently about 100 students are registered in to incubation center
 - The college management funds the money needed for most of the projects

PRINCIPAL
Geethanjali College of Engg. and Tech.
Cheeryal (V), Keesara (M), Medchal Dist.(T.S.)-501 301.

Incubation Activities this year

- Dedicated Research and Development lab, IoT lab
- Faculty team for incubation and EDC activities identified for more committed output
- Couple of faculty trained in Quadcopter basics
- Students identified for incubation activities
- Students currently working on 8 ideas
- Workshops and Project prototypes expected to be completed soon
- Conducted one hackathon
 - Chief guest was Dr. Vijaya Kumari Garu
 - More than 24 projects and 10 new innovative ideas presented

Geethanjali College App



App Launch

Some Incubation activities in news



CSI Student convention



Hackathon - Jan 2018



Raspberry PI Workshop



EDC Activities

- Geethanjali has an MoU with Wadhvani Foundation for last 8 years
- We regularly conduct courses offered by NeN (Wadhvani initiative)
- E-week is conducted every year
 - The E-week for this year is currently being conducted till 6th March 2018.

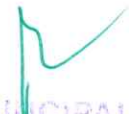
PRINCIPAL
 Geethanjali College of Engg. and Tech.
 Cheeryal (V), Keesara (M), Medchal Dist.(T.S.)-501 301.

EDC – Success Stories

Sl. No.	Name	Branch	Year of Passing
1	Ramesh Ramgopal	CSE	2017
2	BVB Pratap	IT	2015
3	Lalith B	ECE	2014
4	Rahul Krishnan	ECE	2014
5	D.Ramana	ECE	2012
6	Vijay Edara	ECE	2012
7	K.Satish	MCA	2012



Satish Kumar-CEO
Cool PC Tips



Rahul Krishnan

PRINCIPAL

Geethanjali College of Engg. and Tech.
Cheeryal (V), Keesara (M), Medchal Dist.(T.S.)-501 301.



**Geethanjali College of Engineering and
Technology
(UGC Autonomous)**

CHEERYAL (V), KEESARA (M) - 501301, Telangana

Date: 13-9-2017

Respected Coordinators,

In continuation to the circular sent by Principal Sir earlier this month, we will have our first meeting on 14th Sept 2017 at 12:30 PM (Thursday) in CSE Lab 5 (2nd floor Block 1). The agenda of the meeting is as follows

1. Constituent of i-cell
2. Roles and Responsibilities
 - a. Incubation/Innovation
 - b. Industry Interaction
 - c. Entrepreneur Development
3. Schedule of activities

Thanks and Regards

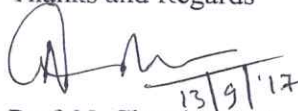

13/9/17
Prof. N. Chandrakanth
Coordinator i-cell

Geethanjali College of Engineering and Technology

Copy to:

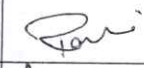
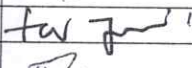
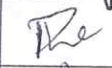
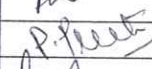
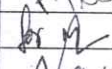
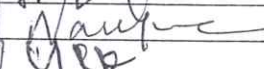
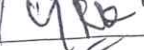
Sl.No.	Name	Dept.	Signature
1	Prof. Siva Kumar Ogirala	ECE	
2	Dr. Sita Madhavi	MBA	
3	Y.V.N. Phani Kishore	CSE	
4	Preeti Prasada	CSE	
5	P. Harish	EEE	
6	B. Subba Rao	ME	
7	M. Rajesh Kumar	CE	

PRINCIPAL
Geethanjali College of Engg. and Tech.
Cheeryal (V), Keesara (M), Medchal Dist.(T.S.)-501 301.

988 231 8166 - Harish EEE



Geethanjali College of Engineering and Technology

(UGC Autonomous)

CHEERYAL (V), KEESARA (M), Medchal Dist. - 501301, Telangana

Date: 16-12-2017

Circular

Respected Coordinators,

We have to plan the activities for the “Center for Innovation and Creativity” and the same for “i-cell”. Please attend the meeting on 19-12-2017 at 3:10 PM, in the CSE Dept Seminar hall. Please attend without fail and come on time.

Agenda:

1. Schedule of Activities for Sem II – AY 2017-18 (Both Incubation and EDC)
2. Plan for Hackathon in January 2018
3. Student nominations





Thanks and Regards:

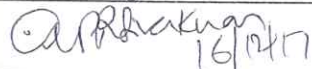
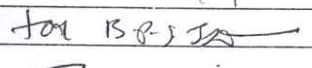
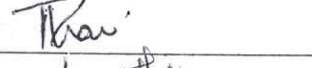
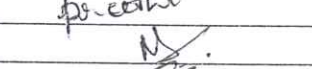

Prof. N. Chandrakanth
Coordinator i-cell

Geethanjali College of Engineering and Technology

Copy to:

Sl.No.	Name	Dept.	Signature
1	Prof. Siva Kumar Ogirala	ECE	
2	Dr. Sita Madhavi	MBA	
3	Y.V.N. Phani Kishore	CSE	
4	Preeti Prasada	CSE	
5	P. Harish	EEE	
6	B. Subba Rao	ME	
7	Y. Rajesh Kumar	CE	

PRINCIPAL
Geethanjali College of Engg. and Tech.
Cheeryal (V), Keesara (M), Medchal Dist.(T.S.)-501 301.

Agenda:- EXCITE

points:-

1. As per the recent meeting with IITOB Director, it is informed to all that IAWITE, BOOTCAMP & EXCITE would be tentatively held on march, April, 2018 for 1st, 2nd & 3rd yr students
2. EXCITE is a 6 weeks summer product engineering workshop
3. Bootcamp is for 2nd year for gaining insights on entrepreneurship
4. Ignite is for 1st year students for awareness on innovation and entrepreneurship.
5. All faculty are requested to nominate 3 students from their respective branches.
6. All the activities have to be published in storage 2 & other social platforms.

A. M. Chandrasekhar N

GUPR. Sivakumar

Dr. Harish Pullori

Preeti Prasada
y.v.v. Phani Mishra

QPR

HR

P. Preeti

PR

PRINCIPAL
Geethanjali College of Engg. and Tech.
Cheerla (V), Keesara (M), Medchal Dist.(T.S.)-501 301.

Agenda:

constitution of incubation cell (I-cell) - JHUB committee.

Points Discussed

1. Institute has signed up with JNTU Innovation Hub (JHUB) for conducting various innovations activities under JHUB in college.
2. As per principal's direction we have to form a committee consisting of faculty members from various departments.
3. All the activities that we have done under I-cell (centre for innovation and creativity) will now be a part of JHUB.

1. Y.V.V. Phani Kishore - Ther
2. O.V.P.R. SIVA KUMAR All
3. B. Subbarao (ME) ~~CA~~
4. K. NIRANJAN KUMAR k n s k m
5. DR. Harish Pilluri Harish
6. B.P.S. Jyothi BPS Jyothi
7. Preeti Prasada P. Preeti

PRINCIPAL
 Geethanjali College of Engg. and Tech.
 Cheeryal (V), Keeravaram (R), Medchal Dist. (T.S.)-501 301.



14/9/17



M O M
I-cell (GCET).

Points Discussed

List of Activities conducted for the AY - 2016-17.

Project Prototypes to be showcased in various college level competitions

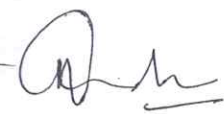
prototype presentations to be submitted by the students on or before 21/9/17.

Prof. N. Chandrakanta -  Dep. Head - 
Prof. V. R. Sivakumar -  14/9/17

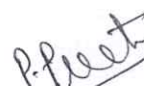
Proect Prasada - 

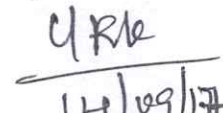
Y. Rajesh Kumar -  14/09/17

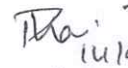
Y. Phani Kishore -  14/9

Dr. A. Sita Madhavi -  14/9/17

K. Venkatesh -  14/9/17

PRINCIPAL
Geethanjali College of Engg. and Tech.
Cheppur (V), Keerasa (M), Medchal Dist. (T.S.) - 501 301.

Agenda:-

Merging of EDC, NEN, Incubation Activities under JHUB

Points Discussed:-

1) As per the directions of principal sir and subsequent meetings with JHUB Direction (Dr. G. Vijaya Kumar) it is advised to merge all the activities which are to be conducted in the college will now be a part of JHUB.

2) EDC and NEN Activities will be conducted by Preeti Prasad of C&E

3) Identify teams from each department and constitute meetings with students for innovation/incubation activities.

4) Each faculty member will be allocated one team they would be guiding the students with respective projects

5) Planned to conduct workshop on Arduino & Raspberry Pi. Prof. N. Chandrababu.

Y. C. W. Phani Kishan -
A. Prakashan

Dr. Harish Pillai

Preeti Prasad

PRINCIPAL
Geethanjali College of Engg. and Tech.
Cheeraj (V), Keonara (M), Madhul Dist. (E.S.)-501 301.

EDC

Points Discussed

1. Since all the innovative projects are nearing to completion it is decided to conduct a hackathon in the college premises on 20-01-18
2. Campaigning would be conducted in & around college of Hyderabad
3. Guest of honor would be Dr. G. Vijaya Kumari (Director - JHUB) and Dr N. Venkatesh Redpine signals
4. We have so far decided that the hackathon consists of two activities 1. Idea presentation 2. Project presentation
5. The idea presentation only for 1st yr students of geet and project presentation open for all
6. So far we have received 10 innovative projects from various Engg colleges
7. Logistics - Harish sir (EEE), J. Uma Mahesh (CSE)
Room allotments - N. Chandrakanth, Y.V.N. Phanikishore

Prof - N. Chandrakanth. 

Dr. Harish Pillori
Y.V.N. Phanikishore

O.V.R. Sivakumar

Preeti Prasada







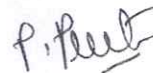



No.GCET/041/2017-18

21.08.2017

OFFICE OF THE PRINCIPAL

CIRCULAR

The “i-cell” (innovation cell) of Geethanjali College of Engineering and Technology will constitute of the following members for the year 2017-18.

Sl.No.	Name	Dept.	Role	Signature
1	Dr. S. Udaya Kumar		Chairman	
2	Prof. N. Chandrakanth	CSE	Convener	
3	Prof. Siva Kumar Ogirala	ECE	Member	
4	Dr. Sita Madhavi	MBA	Member	
5	Y.V.N. Phani Kishore	CSE	Member	
6	Preeti Prasada	CSE	Member	
7	P. Harish	EEE	Member	
8	B. Subba Rao	ME	Member	
9	Y. Rajesh Kumar	CE	Member	

PRINCIPAL

Copy to:

- Secretary Sir's office
- Dean Academics
- Dean Admin
- Members mentioned above

PRINCIPAL
Geethanjali College of Engg. and Tech.
Cheeryal (V), Keesara (M), Medchal Dist.(T.S.)-501 301.



www.jhub.ac.in



The pink circle enclosing the letter 'J' symbolises the incubation cell simultaneously highlighting the letter to cement the fact that JHUB is a JNTU initiative. Also, the letter 'J' is the JNTU logo, surrounded by white dots corresponding to the individual startups or businesses being supported.

PRINCIPAL

Geethanjali College of Engg. and Tech.
Cheerla (V), Keesara (M), Medchal Dist. (R.S.) 501 301.

Incubation

Alumni Startup

Thrust areas of AI/ML, AR/VR, IOT, Cyber physical systems, Avionics, Design & Automation.

Application Format

Name of the Alumnus and details of study at JNTUH:

Name of the startup:

Brief background of the startup:

Technologies working on:

Team Size:

Approximate Space Required:

Current Location:

Description of Project Activities Proposed at J-Hub:

Perceived Benefits:

Proposed Engagement/Collaboration with J-Hub (Students recruitments / faculty R & D interaction, mentoring support to product design / technology workshops / hackathon): please specify hours of engagement.

Any Commercial Activity Planned at J-Hub:

Total Number of Employees to be stationed at J-Hub:

Profile of Key Personnel:

Funding Plans for the Project:

Bootcamps

- Bootcamps for B. Tech I year students team of size 3 shall be nominated by institute open for all colleges.
- Total number of teams will be 50. Ideas are to be presented to solve problems of real world prototype development not expected.
- It will be around 3 day workshop giving fundamentals of Ideation, Design Thinking and Entrepreneurship.
- II nd Year students is open for J-Lab colleges 3 teams from each college.
- Shall be nominated by colleges.
- 20 teams will be shortlisted based on initial screening .
- Students who have participated/conducted NEN activities may be recommended.
- It is a 2-week Bootcamp covering Innovation & Entrepreneurship.

Activities of J-Labs

PRINCIPAL
Geethanjali College of Engg. and Tech.
Cheeryal (V), Keesara (M), Medchal Dist.(T.S.)-501 301.

GEETHANJALI COLLEGE OF ENGINEERING AND TECHNOLOGY

IGNITE STUDENT LIST

S.No	Name	Roll No	Branch	Phone	Email
1	Jyotishwara Prasad A		CSE	9705632126	aiyotish2000@gmail.com
2	M Gokul		CSE	9704704112	mamandurugokul1@gmail.com
3	Aditya Sharma		CSE	8639569330	
4	A Sankeerthana		ECE B	9550306560	sankeerthanaarja@gmail.com
5	Rohit Vishal		ECE B		
6	P. Uday Sai		EEE B	9182338865	pillalamarriuday@gmail.com

PRINCIPAL

Geethanjali College of Engg. and Tech.
Cheeryal (V), Keesara (M), Medchal Dist.(T.S.)-501 301.





Geethanjali College of Engineering and Technology

CHEERYAL (v), KEESARA (M), MEDCHAL DIST – 501301, TELANGANA

HACKATHON-2K18

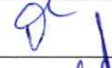
A REPORT ON IDEA PRESENTATION HELD ON 20-01-2018

As a part of HACKATHON-2K18, Idea presentation event was conducted on 20.01.2k18 at E-Class Room, Floor-II, Block-I, GCET. In this event total 15 participants gave their innovative, useful and novel ideas. The judges were impressed by the novel ideas and the way of presentation of the participants. The following students got first, second and third prizes respectively.

S.No.	Name of the Participant	Year, Branch & Section	Roll Number	Prize	Signature of the Judges
01.	P. Carol Navya	II-CSE-D	16R11A05E5	I	1. 
02.	T. Sai Teja Rao	I-CSE-C	17R11A05D5	II	2. 
03.	K.V. Manikantan	I-CSE-C	17R11A05B7	III	3. 
					4. 

All 15 participants are of GCET I & II year students.

Student Coordinators:

Faculty Coordinators:

1. Sai Kumar, EEE, R.No:

15R11A0239



2. Hemendra, EEE, R.No.

15R11A0235

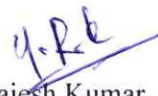
1. Ms. B.P.S. Jyothi, Asst.Prof., MBA-GCET.

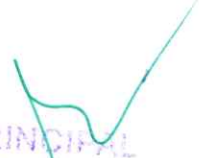

2. Mr.Rajesh Kumar, Asst.Prof., Civil, GCET.

PRINCIPAL
Geethanjali College of Engg. Tech.
Cheeryal (V), Keesara (M), R.R. Dist. (A.P.) - 501 301

Geethanjali College of Engineering and Technology

CHEERYAL (V), KEESARA (M), Medchal DIST-501301, Telangana

Date: 4/1/2018

To,
The Principal,
GCET, Cheeryal.

Respected Sir,

The "Center for Innovation and Creativity" in association with Dept of CSE (GCET) is planning for a Hackathon on 20th Jan 2018. This will be part of the "i-cell" activities of our college which is running in association with JHUB (from JNTU-H).

I request you to please approve the same so that we can conduct the aforesaid Hackathon.

Following are the details of the budget that we are likely to incur...

Sl. No.	Description	Cost
1	Gifts for 2 guests (Inaugural and valedictory)	7000.00
2	Prize Money (3000, 2000, 1500 and 3 consolation prizes of 1000 each).	9500.00
3	Campaign	2000.00
4	News paper publishing	2500.00
5	Printing (Certificates/Banners/ID cards etc)	5500.00
6	2 Bouquets	500.00

Total: Rs. 27,000.00

In addition to the above we will incur the following expenses

Sl. No.	Description	Cost
1.	Lunch (10 Spl Lunch, 25 normal lunch, 100 tea/snack)	4500.00 / AO / Canteen
2.	Transport (campaign and guest pickup/dropoff)	At actual by transport dept

Thanks and Regards

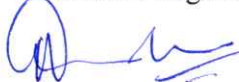

N. Chandrakanth
Convener



Y.V.N. Phani Kishore
Co-Convener

To
A/c

PRINCIPAL
Geethanjali College of Engg. Techn.
Cheeryal (V), Keesara (M), R.R. Dist. (A.P.) - 501 301



16/01/18
Approval sanctioned by
Secretary

Geethanjali College of Engineering and Technology

CHEERYAL (V), KEESARA (M), R.R. DIST-501301, Telangana

Medhant

Date: 4/1/2018

To,
The Principal,
GCET, Cheeryal.

Respected Sir,

The "Center for Innovation and Creativity" in association with Dept of CSE (GCET) are planning for a Hackathon on 20th Jan 2018. This will be part of the "i-cell" activities of our college which is running in association with JHUB (from JNTU-H).

I request you to please approve the same so that we can conduct the aforesaid Hackathon.

Following are the details of the budget that we are likely to incur...

Sl. No.	Description	Cost
1.	Gifts for 2 guests (inaugural and valedictory)	6000.00
2.	Prize Money (3000, 2000, 1500 and 2 consolation prizes of 1000 each).	8500.00
4.	T-Shirts (15*150)	2250.00
5.	Campaign	2000.00
6.	News paper publishing	2500.00

Total: Rs.21,250.00

In addition to the above we will incur the following expenses

Sl. No.	Description	Cost
1.	Lunch (10 Spl Lunch, 25 normal lunch, 100 tea/snack)	4500.00 / AO / Canteen
2.	Transport (campaign and guest pickup/dropoff)	At actual by transport dept
3.	Printing (Brouchers/certificates/Banners/ID cards etc)	5500.00 / AO / Sairam Graphics

Thanks and Regards

N. Chandrakanth

N. Chandrakanth
Convener

~~FDP~~

Y.V.N. Phani Kishore

Y.V.N. Phani Kishore
Co-Convener

~~FDP~~

Geethanjali College of Engineering and Technology
Cheeryal (V), Keesara (M), R.R. Dist. (A.P.) - 501301

Gomes

9177866681



Geethanjali

Phone : 9533791618
Fax : +91-40-24220320
Website : www.geethanjalinstitutions.com
info@gcet.edu.in

Geethanjali College of Engineering and Technology

AUTONOMOUS

(Accredited by NBA, Approved by AICTE, New Delhi)

Sy.No. 33 & 34, Cheeryal (V), Keesara (M), Medchal District. - 501 301.

Date: 18/01/2018

To,

Dr. B. Srinivas,
Professor,
Department of Mechanical Engineering,
Geethanjali College of Engineering and Technology, Hyderabad

Dear Dr. B. Srinivas Garu,

Greetings from Geethanjali College of Engineering and Technology!!!

We thank you for accepting to be a judge for Idea presentation event of "HACKATHON 2K18" conducted at our College's, organized in association with I-Cell – GCET, Computer Society of India (CSI), Hyderabad Chapter and IEEE Student Branch - GCET. The competition is scheduled on Saturday, 20th January, 2018 and will start at 11:00 AM.

Best Regards,

Dr. Udaya Kumar Susarla,

Principal,

Geethanjali College of Engineering and Technology

Geethanjali College of Engineering and Technology
Cheeryal (V), Keesara (M), Medchal District (A.S. 501 301)

Sponsored by **TEJA EDUCATIONAL SOCIETY, HYDERABAD**

Office : Sy. No. 33 & 34, Cheeryal (V), Keesara (M), Medchal Dist. - 501 301.

Phones : 9533791618, 7306295152



Geethanjali

Phone : 9533791618
Fax : +91-40-24220320
Website: www.geethanjalinstitutions.com
info@gcet.edu.in

Geethanjali College of Engineering and Technology

AUTONOMOUS

(Accredited by NBA, Approved by AICTE, New Delhi)

Sy.No. 33 & 34, Cheeryal (V), Keesara (M), Medchal District. - 501 301.

Date: 18/01/2018

To,

Shri. N. Venkatesh

Vice President – Advanced Technologies

Redpine Signals, Hyderabad

Dear Shri N. Venkatesh Garu,

Greetings from Geethanjali College of Engineering and Technology!!!

We thank you for accepting to be our Chief Guest for our College's "HACKATHON – 2K18", organized in association with I-Cell-GCET, Computer Society of India (CSI), Hyderabad Chapter and IEEE Student branch- GCET. It is a great honor to have you here for this memorable occasion. The Valedictory function is scheduled on Saturday, 20th January, 2018.

We shall make transport arrangements for you to commute on this occasion.

We are eagerly looking forward to meet you on this day.

Best Regards,

Dr. Udaya Kumar Susarla,

Principal,

Geethanjali College of Engineering and Technology

PRINCIPAL
Geethanjali College of Engg. Techn.
Cheeryal (V), Keesara (M), R.R. Dist. - 501 301

Sponsored by **TEJA EDUCATIONAL SOCIETY, HYDERABAD**

Office : Sy. No. 33 & 34, Cheeryal (V), Keesara (M), Medchal Dist. - 501 301.

Phones : 9533791618, 7306295152



Geethanjali

Phone : 9533791618
Fax : +91-40-24220320
Website: www.geethanjaliinstitutions.com
info@gcet.edu.in

Geethanjali College of Engineering and Technology

AUTONOMOUS

(Accredited by NBA, Approved by AICTE, New Delhi)

Sy.No. 33 & 34, Cheeryal (V), Keesara (M), Medchal District. - 501 301.

Date: 18/01/2018

To,

Shri. N. Venkatesh
Vice President – Advanced Technologies
Redpine Signals, Hyderabad

Dear Shri N. Venkatesh Garu,

Greetings from Geethanjali College of Engineering and Technology!!!

We thank you for accepting to be our Chief Guest for our College's "HACKATHON – 2K18", organized in association with I-Cell-GCET, Computer Society of India (CSI), Hyderabad Chapter and IEEE Student branch- GCET. It is a great honor to have you here for this memorable occasion. The Valedictory function is scheduled on Saturday, 20th January, 2018.

We shall make transport arrangements for you to commute on this occasion.

We are eagerly looking forward to meet you on this day.

Best Regards,

Dr. Udaya Kumar Susarla,

Principal,

Geethanjali College of Engineering and Technology

FR
Geethanjali College of Engg
Cheeryal (V), Keesara (M), R.R. Dist. (A.P.) - 501 301

Sponsored by TEJA EDUCATIONAL SOCIETY, HYDERABAD

Office : Sy. No. 33 & 34, Cheeryal (V), Keesara (M), Medchal Dist. - 501 301.

Phones : 9533791618, 7306295152



Geethanjali

Phone : 9533791618
Fax : +91-40-24220320
Website: www.geethanjaliinstitutions.com
info@gcet.edu.in

Geethanjali College of Engineering and Technology

AUTONOMOUS

(Accredited by NBA, Approved by AICTE, New Delhi)

Sy.No. 33 & 34, Cheeryal (V), Keesara (M), Medchal District. - 501 301.

Date: 18/01/2018

To,

Shri. O.V.P.R. Siva Kumar,
Professor,
Department of Electronics and Communications Engineering,
Geethanjali College of Engineering and Technology, Hyderabad

Dear Prof. O.V.P.R. Siva Kumar,

Greetings from Geethanjali College of Engineering and Technology!!!

We thank you for accepting to be a judge for Idea presentation event of "HACKATHON 2K18" conducted at our College's, organized in association with I-Cell – GCET, Computer Society of India (CSI), Hyderabad Chapter and IEEE Student Branch - GCET. The competition is scheduled on Saturday, 20th January, 2018 and will start at 11:00 AM.

Best Regards,

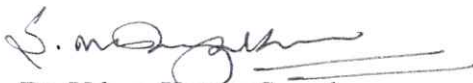
Dr. Udaya Kumar Susarla,

Principal,

Geethanjali College of Engineering and Technology

PRINCIPAL
Geethanjali College of Engg. Tech.
Cheeryal (V), Keesara (M), R.R. Dist. (A.P.) - 501 301

Sponsored by TEJA EDUCATIONAL SOCIETY, HYDERABAD

Office : Sy. No. 33 & 34, Cheeryal (V), Keesara (M), Medchal Dist. - 501 301.

Phones : 9533791618, 7306295152



Geethanjali

Phone : 9533791618
Fax : +91-40-24220320
Website : www.geethanjalinstitutions.com
info@gcet.edu.in

Geethanjali College of Engineering and Technology

AUTONOMOUS

(Accredited by NBA, Approved by AICTE, New Delhi)

Sy.No. 33 & 34, Cheeryal (V), Keesara (M), Medchal District. - 501 301.

Date: 18/01/2018

To,

Shri. N. Venkata Bharadwaj,
Assoc. Professor,
Department of Electrical and Electronics Engineering,
Geethanjali College of Engineering and Technology, Hyderabad

Dear Shri. N. Venkata Bharadwaj Garu,

Greetings from Geethanjali College of Engineering and Technology!!!

We thank you for accepting to be a judge for Idea presentation event of "HACKATHON 2K18" conducted at our College's, organized in association with I-Cell – GCET, Computer Society of India (CSI), Hyderabad Chapter and IEEE Student Branch - GCET. The competition is scheduled on Saturday, 20th January, 2018 and will start at 11:00 AM.

Best Regards,

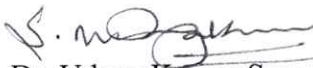
Dr. Udaya Kumar Susarla,

Principal,

Geethanjali College of Engineering and Technology

PRINCIPAL
Geethanjali College of Engg. Tech.
Cheeryal (V), Keesara (M), R.R. Dist. (A.P.) - 501 301

Sponsored by **TEJA EDUCATIONAL SOCIETY, HYDERABAD**

Office : Sy. No. 33 & 34, Cheeryal (V), Keesara (M), Medchal Dist. - 501 301.

Phones : 9533791618, 7306295152



Geethanjali

Phone : 9533791618
Fax : +91-40-24220320
Website: www.geethanjalinstitutions.com
info@gcet.edu.in

Geethanjali College of Engineering and Technology

AUTONOMOUS

(Accredited by NBA, Approved by AICTE, New Delhi)

Sy.No. 33 & 34, Cheeryal (V), Keesara (M), Medchal District. - 501 301.

Date: 18/01/2018

To,

Dr. B. Srinivas,
Professor,
Department of Mechanical Engineering,
Geethanjali College of Engineering and Technology, Hyderabad

Dear Dr. B. Srinivas Garu,

Greetings from Geethanjali College of Engineering and Technology!!!

We thank you for accepting to be a judge for Idea presentation event of "HACKATHON 2K18" conducted at our College's, organized in association with I-Cell – GCET, Computer Society of India (CSI), Hyderabad Chapter and IEEE Student Branch - GCET. The competition is scheduled on Saturday, 20th January, 2018 and will start at 11:00 AM.

Best Regards,

Dr. Udaya Kumar Susarla,

Principal,

Geethanjali College of Engineering and Technology

PRINCIPAL
Geethanjali College of Engg. Tech.
Cheeryal (V), Keesara (M), R.R. Dist. (A.P.) - 501 301

Sponsored by TEJA EDUCATIONAL SOCIETY, HYDERABAD

Office : Sy. No. 33 & 34, Cheeryal (V), Keesara (M), Medchal Dist. - 501 301.

Phones : 9533791618, 7306295152



Geethanjali

Phone : 9533791618
Fax : +91-40-24220320
Website: www.geethanjaliinstitutions.com
info@gcet.edu.in

Geethanjali College of Engineering and Technology

AUTONOMOUS

(Accredited by NBA, Approved by AICTE, New Delhi)

Sy.No. 33 & 34, Cheeryal (V), Keesara (M), Medchal District. - 501 301.

Date: 18/01/2018

To,

Shri. N. Raghava Rao,

Professor,

Department of Computer Science and Engineering,

Geethanjali College of Engineering and Technology, Hyderabad

Dear Prof. N. Raghava Rao Garu,

Greetings from Geethanjali College of Engineering and Technology!!!

We thank you for accepting to be a judge for Idea presentation event of "HACKATHON 2K18" conducted at our College's, organized in association with I-Cell – GCET, Computer Society of India (CSI), Hyderabad Chapter and IEEE Student Branch - GCET. The competition is scheduled on Saturday, 20th January, 2018 and will start at 11:00 AM.

Best Regards,

Dr. Udaya Kumar Susarla,

Principal,

Geethanjali College of Engineering and Technology

PRINCIPAL
Geethanjali College of Engg. Tech.
Cheeryal (V), Keesara (M), R.R. Dist. (A.P.) - 501 301

Sponsored by TEJA EDUCATIONAL SOCIETY, HYDERABAD

Office : Sy. No. 33 & 34, Cheeryal (V), Keesara (M), Medchal Dist. - 501 301.

Phones : 9533791618, 7306295152



Geethanjali

Phone : 9533791618
Fax : +91-40-24220320
Website: www.geethanjalinstitutions.com
info@gcet.edu.in

Geethanjali College of Engineering and Technology

AUTONOMOUS

(Accredited by NBA, Approved by AICTE, New Delhi)

Sy.No. 33 & 34, Cheeryal (V), Keesara (M), Medchal District. - 501 301.

Date: 18/01/2018

To,

Smt. P. Neeraja,
Assoc. Professor,
Department of Civil Engineering,
Geethanjali College of Engineering and Technology, Hyderabad

Dear Ms. P. Neeraja Garu,

Greetings from Geethanjali College of Engineering and Technology!!!

We thank you for accepting to be a judge for Idea presentation event of "HACKATHON 2K18" conducted at our College's, organized in association with I-Cell – GCET, Computer Society of India (CSI), Hyderabad Chapter and IEEE Student Branch - GCET. The competition is scheduled on Saturday, 20th January, 2018 and will start at 11:00 AM.

Best Regards,

Dr. Udaya Kumar Susarla,

Principal,

Geethanjali College of Engineering and Technology

PRINCIPAL
Geethanjali College of Engg. Tech.
Cheeryal (V), Keesara (M), R.R. Dist. (A.P.) - 501 301

Sponsored by TEJA EDUCATIONAL SOCIETY, HYDERABAD

Office : Sy. No. 33 & 34, Cheeryal (V), Keesara (M), Medchal Dist. - 501 301.

Phones : 9533791618, 7306295152



Geethanjali College of Engineering and Technology

CHEERYAL (V), KEESARA (M), Medchal DIST-501301, Telangana

Date: 18-01-2018

To
The Head of Department
Dept. of CSE
GCET

Respected Sir,

Hackathon-2K18 will be conducted on 20th Jan. 2018. We request you to please make arrangement for the following

1. Power spikes in Seminar Hall – 3rd Floor Block 1 GCET
2. WiFi in Seminar Hall – 3rd Floor Block 1 GCET
3. We will be utilizing the Projectors from the CSE dept. for “Idea Presentation”

Thanking you sir,

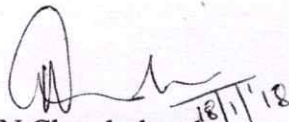
N. Chandrakanth
Convenor

Y.V.N. Phani Kishore
Co-convenor

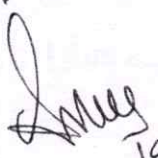
Forwarded to
Mr. Vijay Lakshar Reddy P.N. a

19/1/18

PRINCIPAL
Geethanjali College of Engg. Techn.
Cheeryal (V), Keesara (M), R.R. Dist. (A.P.) - 501301



Geethanjali College of Engineering and Technology

CHEERYAL (V), KEESARA (M), Medchal DIST-501301, Telangana

Date: 16/1/2018

Through Proper Channel

To
The Accounts Officer
GCET.

Respected Sir,

We are conducting Hackathon-2K18 on 20th Jan 2018. The budget for the same is approved by our secretary sir. I request you to please give us a cash advance of Rs. 12000.00 (Twelve thousand only) for the expenses we incur from day to day for this event.

I will produce the details of expenditure along with their receipts (where possible) once the event is complete.

Thanks and Regards

N. Chandrakanth
Convener

TO
A/c
S/he
16/01/18

PCET, CIPAL
Geethanjali College of Engg. Techn.
Cheeryal (V), Keesara (M), Medchal Dist. (A.P.) - 501301



Geethanjali College of Engineering and Technology

CHEERYAL (V), KEESARA (M), Medchal DIST-501301, Telangana

Date: 16-01-2018

Through proper Channel

To
The Administrative Officer
GCET

Respected Sir,

Hackathon-2K18 will be conducted on 20th Jan. 2018. We request you to please make arrangement for the following

1. Generator backup in case there is a power outage.
2. Set up the seminar hall for Inaugural at 10:00 AM and Valedictory at 3:00 PM
 - a. We need 6 chairs at the dais
 - b. Water bottles on the dais
 - c. Please ensure the seminar hall ACs are switched on by 9:00 AM so that it will be cool for inaugural and same for valedictory at 2:00 PM
 - d. Seminar hall to be cleaned day before and chairs arranged
3. Attenders / Ayyas to help for inaugural and Valedictory

Thanking you sir,

N.Chandrakanth
Convenor

Y.V.N. Phani Kishore
Co-convenor

TO
AO for m. apl.

Sik
16/01

PRINCIPAL
Geethanjali College of Engg. Techn.
Cheeryal (V), Keesara (M), R.R. Dist. (A.P.) - 501 301



Geethanjali College of Engineering and Technology (UGC Autonomous)

CHEERYAL (V), KEESARA (M), Medchal (Dist) - 501301, Telangana

Date: 16-01-2018

Respected Coordinators,

Request you to attend the meeting at 3:00 PM in CSE lab 5 (Block 1), to discuss and finalize the following for the upcoming hackathon

1. Schedule/venue etc.,
2. Registration
3. Coordinator list (compeering/anchoring, transport, food, prizes, gifts etc.,) for both faculty and students
4. Activity distribution
5. Any other items for discussion.

Let's make this a grand event. Secretary and Principal Sir are very keen to make this a grand success.

Thanks and Regards

Prof. N. Chandrakanth

Coordinator i-cell

Geethanjali College of Engineering and Technology

Copy to:

Sl.No.	Name	Dept.	Signature
1	Prof. Siva Kumar Ogirala	ECE	
2	B.P.S. Jyothi	MBA	
3	Y.V.N. Phani Kishore	CSE	
4	Preeti Prasada	CSE	
5	P. Harish	EEE	
6	B. Subba Rao	ME	
7	Y. Rajesh Kumar	CE	

PRINCIPAL
Geethanjali College of Engg. Tech.
Cheeryal (V), Keesara (M), R.R. Dist. (A.P.) - 501301

Time
 9:30 AM
 11:50 AM

Principal
 Geethanjali College of Engg. Techn.
 (Cheyral (V), Keerasa (M), R.R. Dist: I.A.R.) - 501 301

Sl. No	Desc.	From	To	Remarks
1	Registration	10:00 AM	12:00 NOON	Harish (EEE) & Vikas (CSE) and Students
2	Inaugural	10:30 AM	11:30 AM	1. Introduction 2. Calling guests to the dias 3. Prayer song and lighting of lamp 4. Convener Address 5. Principal/Patron Address 6. Chairman Sir Address 7. Chief Guest Address 8. Closure
3	Project Display	11:45 AM	1:00 PM	
4	Project Judging	12:00 NOON	2:30 PM	
5	Idea Presentations/Judging	12:00 NOON	2:30 PM	
6	Finalizing of Prizes	2:30 PM	3:00 PM	
7	Valedictory	3:00 PM	4:00 PM	1. Introduction 2. Calling guests to the dias 3. Convener Report 5. Principal/Patron Address 6. Chairman Sir Address 7. Chief Guest Address 8. Prize/Certificate Distribution 9. National Anthem and Closure



Geethanjali College of Engineering and Technology (UGC Autonomous)

CHEERYAL (V), KEESARA (M), Medchal (Dist) - 501301, Telangana

Date: 16-01-2018

Respected Coordinators,

Request you to attend the meeting at 3:00 PM in CSE lab 5 (Block 1), to discuss and finalize the following for the upcoming hackathon

1. Schedule/venue etc.,
2. Registration
3. Coordinator list (compeering/anchoring, transport, food, prizes, gifts etc.,) for both faculty and students
4. Activity distribution
5. Any other items for discussion.

Let's make this a grand event. Secretary and Principal Sir are very keen to make this a grand success.

Thanks and Regards

Prof. N. Chandrakanth
Coordinator i-cell

Geethanjali College of Engineering and Technology

Copy to:

Sl.No.	Name	Dept.	Signature
1	Prof. Siva Kumar Ogirala	ECE	
2	B.P.S. Jyothi	MBA	
3	Y.V.N. Phani Kishore	CSE	
4	Preeti Prasada	CSE	
5	P. Harish	EEE	
6	B. Subba Rao	ME	
7	Y. Rajesh Kumar	CE	

PRINCIPAL
Geethanjali College of Engg. Tech.
Cheeryal (V), Keesara (M), R.R. Dist. (A.P.) - 501 301



Geethanjali College of Engineering and Technology
(UGC Autonomous)

CHEERYAL (V), KEESARA (M), Medchal (Dist) - 501301, Telangana

Date: 16-01-2018

Respected Coordinators,

Request you to attend the meeting at 3:00 PM in CSE lab 5 (Block 1), to discuss and finalize the following for the upcoming hackathon

1. Schedule/venue etc.,
2. Registration
3. Coordinator list (compeering/anchoring, transport, food, prizes, gifts etc.,) for both faculty and students
4. Activity distribution
5. Any other items for discussion.

Let's make this a grand event. Secretary and Principal Sir are very keen to make this a grand success.

Thanks and Regards

Prof. N. Chandrakanth

Coordinator i-cell

Geethanjali College of Engineering and Technology

Copy to:

Sl.No.	Name	Dept.	Signature
1	Prof. Siva Kumar Ogirala	ECE	
2	B.P.S. Jyothi	MBA	
3	Y.V.N. Phani Kishore	CSE	
4	Preeti Prasada	CSE	
5	P. Harish	EEE	
6	B. Subba Rao	ME	
7	Y. Rajesh Kumar	CE	

PRINCIPAL
Geethanjali College of Engg. Tech.
Cheeryal (V), Keesara (M), R.R. Dist. (A.P.) - 501301

S.No	Event	Venue	Faculty Cordina	Phone	Student Cordina	Roll No and Brar	phone	Remarks
1	Registrations Arranging Bouquets / Water Bottles/	Ground floor near Admin Seminar Hall, Block 1	P. Harish (EEE) CH. Vikas (CSE)		8			
2		Seminar Hall, Block 1	Preeti Prasada Harini Krishna		1	16R11A05E2 2 CSE C 16R11A05K4 2		
3	Anchoring	Seminar Hall, Block 1	Preeti Prasada Harini Krishna			17R11A0599 1 CSE C		
4	Prayer Song	Seminar Hall, Block 1	Preeti Prasada Harini Krishna			A. Tejaswini		
5	Transport (for Guests)	-	Y V N Phani Kishore	9000208680				
6	Food / Tea Snack	Canteen (Student Volunteers and			2			
		Special Lunch in Guest Room Tea / Snack during the event to the						
7	Certificate Preparation Banner		Y V N Phani Kishore	9000208680				
8	Preparation and Printing Arrangement of Projectors /		Y V N Phani Kishore	9000208680				
9	Check lists							

- Project Presentation	Seminar Hall, IT Floor Block 1	Subba Rao (Mech)							
- Idea Presentations	AECs Seminar Hall, IT Floor Block 1	Rajesh (civil) Jyothi (MBA) Prof. Shiva							
Projects Judging	Lab 5, Second Floor, Block 1 Eclass 2	Kumar (ECE) N. Venkatesh Dr. Neeraja							
Judging Idea Presentation 1		Rani Dr. Surya Prof. Raghava							
Judging Idea Presentation 1		Rao Mech/Civil ?? Prof. N.							
Procurement of Gifts / Bouquets		Chandranth Y V N Phani	9885723157 9000208680						
DoPY		Y V N Phani Kishore						1	

 PRINCIPAL
 Gachanjan College of Engg. Techn.
 Chervyl (V), Keasara (M), Ranga Reddy Dist. (A.P.) - 501 301



Geethanjali

Phone : 9533791618
Fax : +91-40-24220320
Website: www.geethanjaliinstitutions.com
info@gcet.edu.in

Geethanjali College of Engineering and Technology

AUTONOMOUS

(Accredited by NBA, Approved by AICTE, New Delhi)

Sy.No. 33 & 34, Cheeryal (V), Keesara (M), Medchal District. - 501 301.

Date: 12/01/2018

To,
Dr. Vijaya Kumari,
Dept. of CSE,
JNTU - Hyderabad

Dear Madam,

Sub: - Invitation as Chief Guest for HACKATHON-2K18 at Geethanjali.

Please refer to our Email-Conversation dated 2nd Jan 2018. It is our privilege to invite you as **Chief Guest** for the inaugural session of the **HACKATHON-2K18** being organized at Geethanjali College of Engineering and Technology, which is to be conducted on 20th January, 2018 at 10.00 AM and is likely to end at 11:00 AM.

We will also have the teams from various colleges showcasing their respective prototypes of projects.

Thanking you

Best regards

Dr. Udaya Kumar Susarla

Principal
PRINCIPAL

Geethanjali College of Engg. and Tech.
Cheeryal (V), Keesara (M), Medchal Dist.(T.S.)-501 301.



PRINCIPAL
Geethanjali College of Engg. Tech.
Cheeryal (V), Keesara (M), R.R. Dist. (A.P.) - 501 301

Sponsored by **TEJA EDUCATIONAL SOCIETY, HYDERABAD**

Office : Sy. No. 33 & 34, Cheeryal (V), Keesara (M), Medchal Dist. - 501 301.

Phones : 9533791618, 7306295152



Geethanjali

Phone : 9533791618

Fax : +91-40-24220320

Website : www.geethanjaliinstitutions.com
info@gcet.edu.in

Geethanjali College of Engineering and Technology

AUTONOMOUS

(Accredited by NBA, Approved by AICTE, New Delhi)

Sy.No. 33 & 34, Cheeryal (V), Keesara (M), Medchal District. - 501 301.

Date: 8-1-2018

Chief Patron:

Sri G.R. Ravinder Reddy
Secretary

Patron:

Dr. S Udaya Kumar
Principal

Convener:

N. Chandrakanth
Professor – CSE Dept.

Co-Convener:

Y.V.N. Phani Kishore
Asst. Prof. – CSE Dept.

Respected Sir/Madam,

Sub: Hackathon 2018

We are delighted to inform that our college is organizing the "Hackathon – 2018" for the young technocrats of various Engineering Colleges. This will be conducted on 20th Jan 2018.

A poster furnishing the details is attached with this letter. We solicit an enthusiastic participation from your prestigious Institution. We request you to encourage the students of your institute for active participation in the above said event. Your cooperation in this regard shall be highly appreciated.

As mentioned in the poster the students with team sizes of up to 3 can display IoT related project prototypes which will solve any societal issues/problem. The **registration is free.**

With Warm Regards,



PRINCIPAL
Geethanjali College of Engg. and Tech.
Cheeryal (V), Keesara (M), Medchal Dist.(T.S.)-501 301.

Geethanjali College of Engg. and Tech.
Cheeryal (V), Keesara (M), Medchal Dist. (T.S.) - 501 301.

Sponsored by **TEJA EDUCATIONAL SOCIETY, HYDERABAD**

Office : Sy. No. 33 & 34, Cheeryal (V), Keesara (M), Medchal Dist. - 501 301.

Phones : 9533791618, 7306295152



Phone : 9533791618
Fax : +91-40-24220320
Website : www.geethanjaliinstitutions.com
info@gcet.edu.in

Geethanjali College of Engineering and Technology

AUTONOMOUS

(Accredited by NBA, Approved by AICTE, New Delhi)

Sy.No. 33 & 34, Cheeryal (V), Keesara (M), Medchal District. - 501 301.

Date: 8-1-2018

Chief Patron:

Sri G.R. Ravinder Reddy
Secretary

Patron:

Dr. S Udaya Kumar
Principal

Convener:

N. Chandrakanth
Professor – CSE Dept.

Co-Convener:

Y.V.N. Phani Kishore
Asst. Prof. – CSE Dept.

Respected Sir/Madam,

Sub: Hackathon 2018

We are delighted to inform that our college is organizing the "Hackathon – 2018" for the young technocrats of various Engineering Colleges. This will be conducted on 20th Jan 2018.

A poster furnishing the details is attached with this letter. We solicit an enthusiastic participation from your prestigious Institution. We request you to encourage the students of your institute for active participation in the above said event. Your cooperation in this regard shall be highly appreciated.

As mentioned in the poster the students with team sizes of up to 3 can display IoT related project prototypes which will solve any societal issues/problem. The **registration is free.**

With Warm Regards,



PRINCIPAL
Geethanjali College of Engg. and Tech
Cheeryal (V), Keesara (M), Medchal Dist.(T.S.)-501 301.

PRINCIPAL
Geethanjali College of Engg. Tech.
Cheeryal (V), Keesara (M), R.R. Dist. (A.P.) - 501 301

Sponsored by **TEJA EDUCATIONAL SOCIETY, HYDERABAD**

Office : Sy. No. 33 & 34, Cheeryal (V), Keesara (M), Medchal Dist. - 501 301.

Phones : 9533791618, 7306295152

1

Practical

Goethanjan College of Engg. Techn
(Cheerla (V), Keesara (M), R.R. Dist. (A.P.) - 501 301)

T3

T5

T3

T2

Goethanjan College of Engineering and Technology CHEERLA (V), KEESARA (M), Medchal DIST-501301, Telangana HACKATHON 2K18 Project Presentation 20th Jan 2018						
Sl. No.	Name	College	Year & Branch	Mobile No.	Email ID	Signature
1.	1. D.V. Varma 2. Venkat 3. Vishal vijay M. Abhishek	G CET G CET G CET	ME-3rd EE-3rd ME-3rd	1. 9010227002 2. 8374960636 3. 900842489 9951581269	1. duvarma21@gmail-1 2. Venkatesai@gmail 3.	1. 2. 3.
2.	1. P. Vaswanth 2. Y.S.J. Saivathsa 3. Thilak. K	HITS HITS HITS	Mech 2nd Mech 2nd Mech	1. 8121668305 2. 7416811672 3. 8185900681	1. Vaswanth00143@gmail 2. Saivathsa.yj007@gmail 3. Thilak	1. 2. 3.
3.	1. N. Manikanta Sai 2. M. Sujana 3. P. Tammyaji	G CET G CET G CET	ECE-3C ECE 3B CSE-3B	1. 8686128329 2. 9030819032 3. 9618706487	1. Manikanta Sai 65@gmail.com 2. sujana.destiny@gmail.com 3. tammyaji.pothabathini13@gmail.com	1. 2. 3.
4.	1. A. Naveen Kumar 2. Sai Kalyan 3. Gopi Chandu	G CET G CET G CET	MEC-2B " "	1. 9160576011 2. 8897992963 3. 9908098376	1. Naveenveenkkt@gmail.com 2. 3.	1. 2. 3.

Idea presentation

- 1/ ✓ Ch. Ranjya - w/ I B (GCET) - Carbon Credit
- 2/ ✓ RNV Ramana - CSE II C (GCET) - Smart family
- 3/ ✓ O. Sai Seee Ram - CSE-IA (GCET) - Emergency management system
- 4/ ✓ M. Nidhi - CSE- II D (GCET) - Gas leakage alarming & precautionary safety
- 5/ ✓ P. Carol Nanya - CSE- II D (GCET) - Epilepsy band I
- 6/ ✓ C. Pratyusha - CSE II A (GCET) - Driver Drowsiness Alert System
- 7/ ✓ T. Amulya - CSE II A (GCET) - The Assistant
- 8/ ✓ B. Manisha Reddy - CSE II B (GCET) - Blue / Smart City.
- 9/ ✓ M. Karthik - CSE I C (GCET) - Air pollution Meter with digital dashboard on smartphon
- 10/ ✓ Girish Allam - CSE I C (GCET) - Apprehending Railway track
- 11/ ✓ G. Phushyamithra - CSE I C (GCET) - Smart lock
- 12/ ✓ K. V. Manikanta - CSE I C (GCET) - E-charging III
- 13/ ✓ T. Sai Teja Rao - CSE I C (GCET) - Smart helmet II
- 14/ ✓ S. Tarun - CSE I C (GCET) - Smart Traffic management system
- 15/ ✓ B. Kanya Reddy - EEE-2B (GCET) - Hyperloop.

- Registry \leftarrow Tech Seminar
Projects.

- Marks - Batch wise
- Roll No wise

Tech Seminar - 50 Internship
Major Projs \leftarrow 50 (Internship)
150 (Extracurricular)

- Dead lines - \leftarrow 23rd \downarrow Check out
- 25th with HOD
- 29th submit

- Reports - Projs. \leftarrow Mini
Major - Report
- CD. with - SW
- Docs.
- APP / DB
- etc.

Faculty Coordinators :

Prof. N. Chandrabenth

Y. Rajesh Kumar

A. Santhosh (ME)

N.S. Raghavendra (M.E)

J. UMA MAHESH (CSE)

8374878524

Dr. Harish Pillai

Meeti Prasada

Students:-

1. T. SRIKAR SHARMA

2. Bhavadwaj

17/1/18

17/1/18

17/1/18.

17/1/18

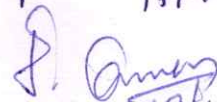
17/1

17/1/18
P. Pruthi





2

T23

T9

Veeru
T3





Geethanjali College of Engineering and Technology

CHEERYAL (V), KEESARA (M), Medchal DIST-501301, Telangana

HACKATHON 2K18

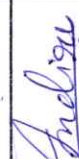
Project Presentation

20th Jan 2018

Sl. No.	Name	College	Year & Branch	Mobile No.	Email ID	Signature
5	1. Saiesh 2. Rahul 3. Bhavana.	G CET	IV th CSE	1. 9640408874 2. 3.	1. saiesh05@gmail.com 2. 3.	 2. 3.
6	1. S. Indira Devi 2. P. Laasya Latha 3. S. Sai Meghana.	G CET	3 rd year ECE	1. 9966462189 2. 3.	1. sitarani.indu@gmail.com 2. 3.	 2. 3.
7	1. T. Sai Venkata Ram 2. Nagalakshmi 3.	G CET	3 rd year ECE 3 rd year CSE	1. 7989942594 2. 9550124003 3.	1. tarunjsv@gmail.com 2. 3.	 2. 3.
8	1. ks. Veerenderanath 2. P. Santosh Rahul 3. Saadiq Ali 4. DSJAYA MADHAVI	G CET G CET G CET	3 rd year ECE 3 rd year ME 3 rd ME 3 rd ECE	1. 8520054854 2. 8125172714 3. 9154020760	1. kemalaveerenderanath@gmail.com 2. santosh.pottabathini@gmail.com 3. Saadiq27ali@gmail.com	 2. 3.  3.

B-S-JA

3

Gothenjali College of Engineering and Technology
Keesara (V), Keesara (M), Medchal DIST-501301, Telangana
Phone: (V) Keesara (M) Dist. (A.P.) - 501 301

Gothenjali College of Engineering and Technology

CHERYAL (V), KEESARA (M), Medchal DIST-501301, Telangana

20th Jan 2018

Project Presentation

HACKATHON 2K18

Sl. No.	Name	College	Year & Branch	Mobile No.	Email ID	Signature
7 ✓	1. AMIT KUMAR	HITS	IV Year	1. 887860291	1. amitrajiswar24@gmail.com	1. Amit
	2. Abhishek Kumar	HITS	IV year	2. 7416258720	2. abhishek.kumar78@gmail.com	2. ASY
	3. TRINA	HITS	IV Year	3. 9963549618	3. trinav999@gmail.com	3. Tina
10 ✓	1. B. Thefesh	GCET	III rd MECH -A	1. 8008863837	1. thefeshnif1978@gmail.com	1. T. Cy
	2. K. JC Pavan Kumar	GCET	III rd ECE -B	2. 9000989876	2. Kjc.pavan@gmail.com	2. KJC
	3. P. Golsima	GCET	III rd CSE -B	3. 9705361971	3. prishmareddy66@gmail.com	3. Golsima
11 ✓	1. Pranav Raju	GCET	IV th ECE	1. 9652139543	1.	1.
	2. Bnubhadraoop	GCET	III rd ECE	2. 9292955580	2.	2.
	3. Koteeti Srikanth	GCET	III rd ECE	3. 9652460964	3.	3.
12 ✓	1. B. Sree Ramu	HITS	III rd year	1. 8106798640	1. Rajju.vanna@gmail.com	1. B. Raju
	2. B. PrasenRathod	HITS	III rd year	2. 9441326496	2.	2.
	3. MO. ShabanZ	HITS	ECE	3. 8086917199	3.	3.

T10

T9

T1

T14

Berkhatali College of Engineering and Technology

CHEERYAL (V), KEESARA (M), MedchalDIST-501301, Telangana

HACKATHON 2K18

Project Presentation

20th Jan 2018

Sl. No.	Name	College	Year & Branch	Mobile No.	Email ID	Signature
17	1. B. Suchakar 2. S. Narech 3. G. Saichaw	Holy Mary tube science	EEE 3rd yr	1. 7093432185 2. 9160689639 3.	1. Saieshwar311@gmail.com 2. narech.sachin1947@gmail.com 3.	1. [Signature] 2. [Signature] 3.
18	1. J. Haritha 2. J. Pranay 3. P. Krishna Sai	VBIT	EEE II yr	1. 9494363738 2. 9491363284 3.	1. Jonnalagadda.Haritha@gmail.com 2. 3.	1. Haritha 2. J. Pranay 3. Krishnasai
19	1. P. Mahendra 2. Siddhathar 3. S. Sri Krishna	GICET	III rd yr ECE	1. 8523009965 2. 9391119899 3. 9849748342	1. mahindhoredy8100@gmail.com 2. Siddharthagoudo11@gmail.com 3. Edavekrisishna@gmail.com	1. [Signature] 2. [Signature] 3. [Signature]
20	1. T. Brahm prabali 2. G. Achole 3. N. Saikumar	HITS	EEE	1. 9603989417 2. 8142413042 3.	1. thummalabhramprabali@gmail.com 2. 3.	1. [Signature] 2. [Signature] 3. [Signature]

X

17

Cheeryal (V), Keesara (M), Medchal Dist. (A.P.) - 501301
 5

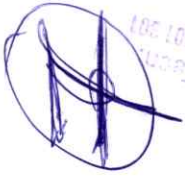

Goethe Institute of Engineering & Technology
K.R. Durgam Cheruvu, Hyderabad-501301

Goethe Institute of Engineering and Technology

CHEERYAL (V), KEESARA (M), MedchalDIST-501301, Telangana

HACKATHON 2K18

Project Presentation

20th Jan 2018

Sl. No.	Name	College	Year & Branch	Mobile No.	Email ID	Signature
23	1. CH. Mahender	Holy Mary	IV EEE	1. 9014568450	1. mahi.challu7@gmail.com	1.
	2. M. Prashanth			2. 9963896899	2. prashanthgoud.murug4@gmail.com	2.
	3. K. Rajasree 3. K. Rajasree			3.	3.	3.
24	1. M. Vijay	Holy Mary	IV EEE	1. 8885664905	1. vijaybennam.washed@gmail.com	1.
	2. B. Ajay			2.	2.	
	3. B. Prathyusha			3.	3.	
	1.			1.		1.
	2.			2.		2.
	3.			3.		3.
	1.			1.		1.
	2.			2.		2.
	3.			3.		3.

Geethanjali College of Engineering and Technology

CHEERVAL (V), KEESARA (M), MedchalDIST-501301, Telangana

HACKATHON 2K18

Idea Presentation

20th Jan 2018

Sl. No.	Name	Year	Branch and section	Roll No	Mobile No.	Email ID	Time	Room	Signature
1	Girish Allam	1st	CSEC	5B1 HR11A058	8465989824	girish10socks@gmail.com			
2	G. Anitha	1st	n						
3	S. Tarun	1st	u	5D6	9121588486	tarun.sowikar@gmail.com			
4	K.V. Manikanta	1st	u	5B7	9985754588	kkmani5899@gmail.com			
5	T. Saiteja	1st	u	5D5	9100494864	Saiteja0704@gmail.com			
6	M. Kasthik	1st	u	5C4	7337094004	manthori.kasthik09@gmail.com			
7	G. Phushyammithra	1st	u	5B0	9618358698	gauriphusyammithra@gmail.com			
8	B. Kanya Reddy	2nd	EEE-2B	16R1A059	9951661989	Kanyareddy906@gmail.com			
8	Ch. Ramya	2nd	CN11-2B	16R1A057	9618060186	ramyatejuru@gmail.com			

Geethanjali College of Engg. Tech.
 Cheerval (V), Keesara (M), Dist. (A.P.) - 501301



Geethanjali College of Engineering and Technology

CHERYAL (V), KEESARA (M), MedchalDIST-501301, Telangana

Idea Presentation

HACKATHON 2K18

20th Jan 2018

Sl. No.	Name	Year	Branch and section	Roll No	Mobile No.	Email ID	Time	Room	Signature
1	KNN RAMANA	J.C	CSE	16R1A065A7	8099534253	K.N.V.SRAMANA234@gmail.com			
									

Geethanjali College of Engg. Techn.
Cheryal (V), Keesara (M), R.R. Dist. (A.P.) - 501 301

3rd. Campaign \leftarrow Student Campaign \rightarrow Certificates
 CAC Members \rightarrow ask students to personally invite
 4th collection of Projects.
 5th Time - Tentative 2:30 PM - 4:00 PM
 Venue. - AECS Lab } ?
 - Seminar Hall }
 - Projector }

Template for Presentation:

- 1) Jan 20th - Arduino ✓
- 2) Jan 21st - Raspberry PI ✓
- 3) 2 days - Android - 10th & 11th Feb.
- 4) 2 days - Quadcopter - 10th & 11th March.

\rightarrow Contact Dr. Vijaya from JNTU-H (:-cell)

- Depts. letters

9959701905

19th / 20th

- \rightarrow Banner (6x4) - 500/-
- \rightarrow Posters - 400/-
- \rightarrow Certificates - 450/-
- \rightarrow Intimate faculty (coordinators)
- \rightarrow Tea / snack - 1000/-
- \rightarrow Prizes ?
- \rightarrow Money reimbursement

PRINCIPAL
 Department of Engg. Tech.
 JNTU-H, Keesara (M), R.R. Dist. (A.P.) - 501 301



Geethanjali

Phone : 9533791618
Fax : +91-40-24220320
Website: www.geethanjaliinstitutions.com
info@gcet.edu.in

Geethanjali College of Engineering and Technology

AUTONOMOUS

(Accredited by NBA, Approved by AICTE, New Delhi)

Sy.No. 33 & 34, Cheeryal (V), Keesara (M), Medchal District. - 501 301.

Date: 21st January, 2018

Sub: Letter of Appreciation: Reg

This is to certify that **Mr. K. Deepak** bearing Roll no: **15R11A04N5** has coordinated for HACKATHON 2K18 organized on 20th January, 2018 in association with I-Cell- GCET, CSI – Hyderabad Chapter, IEEE Student Branch- GCET

The management of Geethanjali College of Engineering and Technology would like to thank and look forward to your participation in future events.

Best Regards,

Prof N. Chandrakanth,

Convener

PRINCIPAL
Geethanjali College of Engg. Tech.
Cheeryal (V), Keesara (M), R.R. Dist. (A.P.) - 501 301

Sponsored by **TEJA EDUCATIONAL SOCIETY, HYDERABAD**

Office : Sy. No. 33 & 34, Cheeryal (V), Keesara (M), Medchal Dist. - 501 301.

Phones : 9533791618, 7306295152



Geethanjali

Phone : 9533791618

Fax : +91-40-24220320

Website: www.geethanjaliinstitutions.com
info@gcet.edu.in

Geethanjali College of Engineering and Technology

AUTONOMOUS

(Accredited by NBA, Approved by AICTE, New Delhi)

Sy.No. 33 & 34, Cheeryal (V), Keesara (M), Medchal District. - 501 301.

Date: 21st January, 2018

Sub: Letter of Appreciation: Reg

This is to certify that **Ms. P. Tanmayi** bearing Roll no: **15R11A05A5** has coordinated for HACKATHON 2K18 organized on 20th January, 2018 in association with I-Cell- GCET, CSI – Hyderabad Chapter, IEEE Student Branch- GCET

The management of Geethanjali College of Engineering and Technology would like to thank and look forward to your participation in future events.

Best Regards,

Prof N. Chandrakanth,

Convener

PRINCIPAL
Geethanjali College of Engg. Techn.
Cheeryal (V), Keesara (M), R.R. Dist. (A.P.) - 501 301

Sponsored by **TEJA EDUCATIONAL SOCIETY, HYDERABAD**

Office : Sy. No. 33 & 34, Cheeryal (V), Keesara (M), Medchal Dist. - 501 301.

Phones : 9533791618, 7306295152



Geethanjali

Phone : 9533791618
Fax : +91-40-24220320
Website: www.geethanjaliinstitutions.com
info@gcet.edu.in

Geethanjali College of Engineering and Technology

AUTONOMOUS

(Accredited by NBA, Approved by AICTE, New Delhi)

Sy.No. 33 & 34, Cheeryal (V), Keesara (M), Medchal District. - 501 301.

Date: 21st January, 2018

Sub: Letter of Appreciation: Reg

This is to certify that **Mr. N. Sai Kumar** bearing Roll no: **15R11A0239** has coordinated for HACKATHON 2K18 organized on 20th January, 2018 in association with I-Cell- GCET, CSI – Hyderabad Chapter, IEEE Student Branch- GCET

The management of Geethanjali College of Engineering and Technology would like to thank and look forward to your participation in future events.

Best Regards,

Prof N. Chandrakanth,

Convener

PRINCIPAL
Geethanjali College of Engg. Tech.
Cheeryal (V), Keesara (M), R.R. Dist. (A.P.) - 501 301

Sponsored by **TEJA EDUCATIONAL SOCIETY, HYDERABAD**

Office : Sy. No. 33 & 34, Cheeryal (V), Keesara (M), Medchal Dist. - 501 301.

Phones : 9533791618, 7306295152



Geethanjali

Phone : 9533791618
Fax : +91-40-24220320
Website: www.geethanjaliinstitutions.com
info@gcet.edu.in

Geethanjali College of Engineering and Technology

AUTONOMOUS

(Accredited by NBA, Approved by AICTE, New Delhi)

Sy.No. 33 & 34, Cheeryal (V), Keesara (M), Medchal District. - 501 301.

Date: 21st January, 2018

Sub: Letter of Appreciation: Reg

This is to certify that **Mr. Hemendra** bearing Roll no: **15R11A0235** has coordinated for HACKATHON 2K18 organized on 20th January, 2018 in association with I-Cell- GCET, CSI – Hyderabad Chapter, IEEE Student Branch- GCET

The management of Geethanjali College of Engineering and Technology would like to thank and look forward to your participation in future events.

Best Regards,

Prof N. Chandrakanth,

Convener

PRINCIPAL
Geethanjali College of Engg. Techn.
Cheeryal (V), Keesara (M), R.R. Dist. (A.P.) - 501 301

Sponsored by **TEJA EDUCATIONAL SOCIETY, HYDERABAD**

Office : Sy. No. 33 & 34, Cheeryal (V), Keesara (M), Medchal Dist. - 501 301.

Phones : 9533791618, 7306295152



Geethanjali

Phone : 9533791618

Fax : +91-40-24220320

Website: www.geethanjaliinstitutions.com
info@gcet.edu.in

Geethanjali College of Engineering and Technology

AUTONOMOUS

(Accredited by NBA, Approved by AICTE, New Delhi)

Sy.No. 33 & 34, Cheeryal (V), Keesara (M), Medchal District. - 501 301.

Date: 21st January, 2018

Sub: Letter of Appreciation: Reg

This is to certify that **Ms. D.V.N. Ramya Samhitha** bearing Roll no: **15R11A05K3** has coordinated for HACKATHON 2K18 organized on 20th January, 2018 in association with I-Cell- GCET, CSI – Hyderabad Chapter, IEEE Student Branch- GCET

The management of Geethanjali College of Engineering and Technology would like to thank and look forward to your participation in future events.

Best Regards,

Prof N. Chandrakanth,

Convener

PRINCIPAL
Geethanjali College of Engg. Tech.
Cheeryal (V), Keesara (M), R.K. Dist. (A.P.) - 501 301

Sponsored by **TEJA EDUCATIONAL SOCIETY, HYDERABAD**

Office : Sy. No. 33 & 34, Cheeryal (V), Keesara (M), Medchal Dist. - 501 301.

Phones : 9533791618, 7306295152



Geethanjali

Phone : 9533791618

Fax : +91-40-24220320

Website: www.geethanjaliinstitutions.com
info@gcet.edu.in

Geethanjali College of Engineering and Technology

AUTONOMOUS

(Accredited by NBA, Approved by AICTE, New Delhi)

Sy.No. 33 & 34, Cheeryal (V), Keesara (M), Medchal District. - 501 301.

Date: 21st January, 2018

Sub: Letter of Appreciation: Reg

This is to certify that **Mr. Dikshant Joshi** bearing Roll no: **15R11A0317** has coordinated for HACKATHON 2K18 organized on 20th January, 2018 in association with I-Cell- GCET, CSI – Hyderabad Chapter, IEEE Student Branch- GCET

The management of Geethanjali College of Engineering and Technology would like to thank and look forward to your participation in future events.

Best Regards,

Prof N. Chandrakanth,

Convener

Geethanjali College of Engineering and Technology
Cheeryal (V), Keesara (M), R.R. Dist. (A.P.) - 501 301

Sponsored by **TEJA EDUCATIONAL SOCIETY, HYDERABAD**

Office : Sy. No. 33 & 34, Cheeryal (V), Keesara (M), Medchal Dist. - 501 301.

Phones : 9533791618, 7306295152



Geethanjali

Phone : 9533791618
Fax : +91-40-24220320
Website: www.geethanjaliinstitutions.com
info@gcet.edu.in

Geethanjali College of Engineering and Technology

AUTONOMOUS

(Accredited by NBA, Approved by AICTE, New Delhi)

Sy.No. 33 & 34, Cheeryal (V), Keesara (M), Medchal District. - 501 301.

Date: 21st January, 2018

Sub: Letter of Appreciation: Reg

This is to certify that **Ms. D.S. Jaya Madhavi** bearing Roll no: **15R11A0472** has coordinated for HACKATHON 2K18 organized on 20th January, 2018 in association with I-Cell- GCET, CSI – Hyderabad Chapter, IEEE Student Branch- GCET

The management of Geethanjali College of Engineering and Technology would like to thank and look forward to your participation in future events.

Best Regards,

Prof N. Chandrakanth,

Convener

Geethanjali College of Engg. Tech.
Cheeryal (V), Keesara (M), R.R. Dist. (A.P.) - 501 301

Sponsored by TEJA EDUCATIONAL SOCIETY, HYDERABAD

Office : Sy. No. 33 & 34, Cheeryal (V), Keesara (M), Medchal Dist. - 501 301.

Phones : 9533791618, 7306295152



Geethanjali

Phone : 9533791618
Fax : +91-40-24220320
Website: www.geethanjaliinstitutions.com
info@gcet.edu.in

Geethanjali College of Engineering and Technology

AUTONOMOUS

(Accredited by NBA, Approved by AICTE, New Delhi)

Sy.No. 33 & 34, Cheeryal (V), Keesara (M), Medchal District. - 501 301.

Date: 21st January, 2018

Sub: Letter of Appreciation: Reg

This is to certify that **Mr. Sai Vishal Danturty** bearing Roll no: **15R11A05Q0** has coordinated for HACKATHON 2K18 organized on 20th January, 2018 in association with I-Cell- GCET, CSI – Hyderabad Chapter, IEEE Student Branch- GCET

The management of Geethanjali College of Engineering and Technology would like to thank and look forward to your participation in future events.

Best Regards,

Prof N. Chandrakanth,

Convener

PRINCIPAL
Geethanjali College of Engg. Techn.
Cheeryal (V), Keesara (M), R.R. Dist. (A.P.) - 501 301

Sponsored by **TEJA EDUCATIONAL SOCIETY, HYDERABAD**

Office : Sy. No. 33 & 34, Cheeryal (V), Keesara (M), Medchal Dist. - 501 301.

Phones : 9533791618, 7306295152



Geethanjali

Phone : 9533791618
Fax : +91-40-24220320
Website: www.geethanjalinstitutions.com
info@gcet.edu.in

Geethanjali College of Engineering and Technology

AUTONOMOUS

(Accredited by NBA, Approved by AICTE, New Delhi)

Sy.No. 33 & 34, Cheeryal (V), Keesara (M), Medchal District. - 501 301.

Date: 21st January, 2018

Sub: Letter of Appreciation: Reg

This is to certify that **Ms. A. Tejaswini** bearing Roll no: **17R11A0599** has coordinated for HACKATHON 2K18 organized on 20th January, 2018 in association with I-Cell- GCET, CSI – Hyderabad Chapter, IEEE Student Branch- GCET

The management of Geethanjali College of Engineering and Technology would like to thank and look forward to your participation in future events.

Best Regards,

Prof N. Chandrakanth,

Convener

PRINCIPAL
Geethanjali College of Engg. Techn.
Cheeryal (V), Keesara (M), R.R. Dist. (A.P.) - 501 301.

Sponsored by **TEJA EDUCATIONAL SOCIETY, HYDERABAD**

Office : Sy. No. 33 & 34, Cheeryal (V), Keesara (M), Medchal Dist. - 501 301.

Phones : 9533791618, 7306295152



Geethanjali

Phone : 9533791618
Fax : +91-40-24220320
Website: www.geethanjaliinstitutions.com
info@gcet.edu.in

Geethanjali College of Engineering and Technology

AUTONOMOUS

(Accredited by NBA, Approved by AICTE, New Delhi)

Sy.No. 33 & 34, Cheeryal (V), Keesara (M), Medchal District. - 501 301.

Date: 21st January, 2018

Sub: Letter of Appreciation: Reg

This is to certify that **Mr. V. Ramesh Rahul** bearing Roll no: **16R11A05E2** has coordinated for HACKATHON 2K18 organized on 20th January, 2018 in association with I-Cell- GCET, CSI – Hyderabad Chapter, IEEE Student Branch- GCET

The management of Geethanjali College of Engineering and Technology would like to thank and look forward to your participation in future events.

Best Regards,

Prof N. Chandrakanth,

Convener

Geethanjali College of Engineering and Technology
Cheeryal (V), Keesara (M), R.R. Dist. (A.P.) - 501 301

Sponsored by **TEJA EDUCATIONAL SOCIETY, HYDERABAD**

Office : Sy. No. 33 & 34, Cheeryal (V), Keesara (M), Medchal Dist. - 501 301.

Phones : 9533791618, 7306295152



Geethanjali

Phone : 9533791618
Fax : +91-40-24220320
Website: www.geethanjaliinstitutions.com
info@gcet.edu.in

Geethanjali College of Engineering and Technology

AUTONOMOUS

(Accredited by NBA, Approved by AICTE, New Delhi)

Sy.No. 33 & 34, Cheeryal (V), Keesara (M), Medchal District. - 501 301.

Date: 21st January, 2018

Sub: Letter of Appreciation: Reg

This is to certify that **Mr. P. Vishal Vinay** bearing Roll no: **15R11A0343** has coordinated for HACKATHON 2K18 organized on 20th January, 2018 in association with I-Cell- GCET, CSI – Hyderabad Chapter, IEEE Student Branch- GCET

The management of Geethanjali College of Engineering and Technology would like to thank and look forward to your participation in future events.

Best Regards,

Prof N. Chandrakanth,

Convener

Geethanjali College of Engineering and Technology
Cheeryal (V), Keesara (M), R.R. Dist. (A.P.) - 501 301

Sponsored by **TEJA EDUCATIONAL SOCIETY, HYDERABAD**

Office : Sy. No. 33 & 34, Cheeryal (V), Keesara (M), Medchal Dist. - 501 301.

Phones : 9533791618, 7306295152



Geethanjali

Phone : 9533791618
Fax : +91-40-24220320
Website: www.geethanjaliinstitutions.com
info@gcet.edu.in

Geethanjali College of Engineering and Technology

AUTONOMOUS

(Accredited by NBA, Approved by AICTE, New Delhi)

Sy.No. 33 & 34, Cheeryal (V), Keesara (M), Medchal District. - 501 301.

Date: 21st January, 2018

Sub: Letter of Appreciation: Reg

This is to certify that **Mr. C.V.S.B. Bharadwaj** bearing Roll no: **15R11A0314** has coordinated for HACKATHON 2K18 organized on 20th January, 2018 in association with I-Cell- GCET, CSI – Hyderabad Chapter, IEEE Student Branch- GCET

The management of Geethanjali College of Engineering and Technology would like to thank and look forward to your participation in future events.

Best Regards,

Prof N. Chandrakanth,

Convener

PRINCIPAL
Geethanjali College of Engineering and Technology
Cheeryal (V), Keesara (M), R.R. Dist. (A.P.) - 501 301

Sponsored by **TEJA EDUCATIONAL SOCIETY, HYDERABAD**

Office : Sy. No. 33 & 34, Cheeryal (V), Keesara (M), Medchal Dist. - 501 301.

Phones : 9533791618, 7306295152



Geethanjali

Phone : 9533791618
Fax : +91-40-24220320
Website : www.geethanjaliinstitutions.com
info@gcet.edu.in

Geethanjali College of Engineering and Technology

AUTONOMOUS

(Accredited by NBA, Approved by AICTE, New Delhi)

Sy.No. 33 & 34, Cheeryal (V), Keesara (M), Medchal District. - 501 301.

Date: 21st January, 2018

Sub: Letter of Appreciation: Reg

This is to certify that **Mr. T. Srikar Sharma** bearing Roll no: **15R11A0352** has coordinated for HACKATHON 2K18 organized on 20th January, 2018 in association with I-Cell- GCET, CSI – Hyderabad Chapter, IEEE Student Branch- GCET

The management of Geethanjali College of Engineering and Technology would like to thank and look forward to your participation in future events.

Best Regards,

Prof N. Chandrakanth,

Convener

PRINCIPAL
Geethanjali College of Engg. Tech.
Cheeryal (V), Keesara (M), R.R. Dist. (A.P.) - 501 301

Sponsored by **TEJA EDUCATIONAL SOCIETY, HYDERABAD**

Office : Sy. No. 33 & 34, Cheeryal (V), Keesara (M), Medchal Dist. - 501 301.

Phones : 9533791618, 7306295152



Geethanjali

Phone : 9533791618
Fax : +91-40-24220320
Website : www.geethanjaliinstitutions.com
info@gcet.edu.in

Geethanjali College of Engineering and Technology

AUTONOMOUS

(Accredited by NBA, Approved by AICTE, New Delhi)

Sy.No. 33 & 34, Cheeryal (V), Keesara (M), Medchal District. - 501 301.

Date: 21st January, 2018

Sub: Letter of Appreciation: Reg

This is to certify that **Mr. K. Vaishnav** bearing Roll no: **16R11A0125** has coordinated for HACKATHON 2K18 organized on 20th January, 2018 in association with I-Cell- GCET, CSI – Hyderabad Chapter, IEEE Student Branch- GCET

The management of Geethanjali College of Engineering and Technology would like to thank and look forward to your participation in future events.

Best Regards,

Prof N. Chandrakanth,

Convener

PRINCIPAL
Geethanjali College of Engg. Tech.
Cheeryal (V), Keesara (M), R.R. Dist. (A.P.) - 501 301

Sponsored by **TEJA EDUCATIONAL SOCIETY, HYDERABAD**

Office : Sy. No. 33 & 34, Cheeryal (V), Keesara (M), Medchal Dist. - 501 301.

Phones : 9533791618, 7306295152



Geethanjali College of Engineering and Technology

An UGC Autonomous Institution

Approved by AICTE, Permanently Affiliated to JNTUH, Accredited by NAAC with 'A' grade, & NBA (New Delhi)
Cheerlathur(V), Keerasa(M), Medchal Dist. 501301



HACKATHON - 2K18

CERTIFICATE OF MERIT

This is to certify that Mr. / Ms. N. MOUNIKA REDDY of
GCEET won First prize in Hackathon 2K18

held at Geethanjali College of Engineering and Technology

on 20th January, 2018.

PROF. N. CHANDRAKANTH
(CONVENER)

DR. UDAYA KUMAR SUSARLA
(PATRON)

PRINCIPAL
Geethanjali College of Engineering and Technology
Cheerlathur (V), Keerasa (M), Medchal Dist. (A.P.) - 501301

Geethanjali College of Engineering and Technology



An UGC Autonomous Institution

Approved by AICTE, Permanently Affiliated to JNTUH, Accredited by NAAC with 'A' grade, & NBA (New Delhi) Cheerayal(V), Keesara(M), Medchal Dist. 501301

HACKATHON - 2K18 CERTIFICATE OF MERIT

This is to certify that Mr. / Ms. M. PRADHYUMNA of GCET won First prize in Hackathon 2K18

held at Geethanjali College of Engineering and Technology
on 20th January, 2018.

PROF. H. CHANDRAKANTH
Geethanjali College of Engg. Techn.
Cheerayal(V), Keesara (M), R.R. Dist. (A.P.) 501301

PROF. H. CHANDRAKANTH
(CONVENER)

DR. UDAYA KUMAR SUSHARLA
(PATRON)

K. Kashyap
2-10-18

Problems
Stat
(10)

f.i.
(20M)
creat/5m

Presentata
(10M)

Social
Impact
(10M)

Total
(50M)

	Problems Stat (10)	f.i. (20M) creat/5m	Presentata (10M)	Social Impact (10M)	Total (50M)
6) Prathusha Driver Processing About SRS.	05	08	06	08	27
7) Anure Assistant	05	08	08	08	27 29
8) Manisha Blue city	05	08	07	07	27
9) Karthik Air Pollution	05	08	05	07	25
10) Disha airss Railway tracks	05	08	08	08	29
11) P. Mishra Smart Ledc	05	07	07	07	26
12) E-charging Mamikanta	06	09	09	08	32
13) Smart Helmet SciTela	05	07	07	07	26

1.	Problem St (10)	Soln (20)	Present 10	Social Impact 10	Total
Carbon Credits (1)	6	10	8	8	
Smart Farming (2)	8	10	7	9	
Emergency Management (3)	9	10	7	9	(1)
Gas Leakage (4)	8	12	9	8	
Epilepsy Band (5)	9	17	9	9	(2)
Drowsiness (6)	6	10	7	8	
The Assistant (7)	5	10	7	7	
Blue Curls (8)	3	5	5	3	

Cheerful College of Engg. Techn.
 Cheeryal (V), Keesara (M), R.R. Dist. (A.P.)-501301

N.V.R.

N.V. Ratadwaj
Assoc. Prof
EEE

ton ton

8. Blue City 04.	04	06	03	17
9. Air Pollution meter. 03	03	08	05	15
10. Apprehending Railway tracks. 4.	4	3	3	14
11. Smart Lock. (1 Year) 3	3	3	4	13
12. E-Charging 1 Year 3	3	3	3	12
13. Smart Helmet. 1 Year 4	4	4	5	17
14. TOT Traffic Signal Monitoring System. 3	3			14
15. HYPER LOOP 5	3	3	3	14

Geethanjali College of Engg. Tech.
Veerayal (V), Keesara (M), R.R. Dist. (A.P.) - 501 302

PRINCIPAL

14

Neeraja

<u>S.No</u>	<u>Problem Name.</u> (10)	<u>Problem start</u> (20)	<u>Solution</u> (20)	<u>Presentation</u> (10)	<u>Social Impact</u> (10)	<u>Total</u> (50)
1.	Ch-Ramya	8	12	7	8	
2.	Smart farming	8	14	8	8	
3.	EMS.	8	10	7	8	
4.	Gas leakage	8	16	9	8	
5.	Epilepsy	9	16	9	9	I
6.	door doorbrowns alert system	8	14	7	8	
7.	Assistant	8	13	7	7	
8.	Blue city	7	14	8	7	
9.	Air pollution	8	12	6	8	

PRINCIPAL
 Geethanjali College of Engg. Tech.
 Cheerpal (V), Koppur (M), R.R. Dist. (A.P.) - 507 307
 6

CASH BILL Ph: 040-40203005

BEST DIGITALS

A0, A1, A2, Print Copy Scan, A3, A4, 12x18, 13x19
 Photos, Project, Autocad Prints, Scanning, Internet,
 Lamination, Programme Cutting, Spiral Binding,
 Bhavani Shopping Complex ECIL X Roads, Hyd-62.

No. **070** Date: 18/01/18

Sl No.	PARTICULARS	Qty.	Rate	AMOUNT Rs.	Ps.
	A, 4	15	15	225	
	CIP				
TOTAL				225	00

Signature: *[Signature]*

PRINCIPAL
 Gaesthanjali College of Engg. Tech.
 Keesara (A), R.R. Dist. (A.P.) - 501 301

CREDIT MEMO

From: No. Date: 19/1/18

M/s. **PARTICULARS** **RATE** **AMOUNT** **Ps.**

	Bouquet			500	1
	Flowers			120	1
TOTAL				620	1

Thanks Visit Again

*Goods once sold will not be taken back or exchanged.

Signature: _____

THANK YOU FOR SHOPPING
 AVOID PLASTIC SAVE ENVIRONMENT

SREE SAI SUPERMARKET
 PLOT NO.62, SRI CHAKRA ENCLAVE,
 SAIPURI, SAINIKPURI, SEC-BAD-94,
 PH.84511186, 27112284,
 GST-36ABPFS9139Q1ZZ.

Pos : 2 User : SATYA Bill : 00000084
 Date : 18/01/2018 Time : 18:56:54

Description	Qty	Rate	Amount
ANURAG POOJ	1.000	50.00	50.00
SGST@2.50%	1.19	CGST@2.50%	1.19
KOTI CANDLE	1.000	34.00	34.00
HSN@GST: 34060010@12%			
SGST@6.00%	1.82	CGST@6.00%	1.82
HOME LITE M	1.000	6.00	6.00
HSN@GST: 3605@18%			
SGST@9.00%	0.46	CGST@9.00%	0.46
AMBICA PURE	1.000	45.00	45.00
HSN@GST: 29142922@18%			
SGST@9.00%	3.43	CGST@9.00%	3.43
ANURADHA PO	1.000	20.00	20.00

Items/Qty : 5/ 5.000
 TOTAL RS 155.00

Tendered-CASH RS 500.00
 Change -CASH RS 345.00

GST%	Qty	Amount	Tax Amt
5.00 %	1	RS 47.82	2.38
SGST@2.50 %	1.19	CGST@2.50 %	1.19
0.00 %	1	RS 20.00	0.00
SGST@0.00 %	0.00	CGST@0.00 %	0.00
12.00 %	1	RS 30.36	3.64
SGST@6.00 %	1.82	CGST@6.00 %	1.82
18.00 %	2	RS 43.22	7.78
SGST@9.00 %	3.89	CGST@9.00 %	3.89

M.S.T. No: 27430268741V

Thank You! Visit Again



SRI VENKATESHWARA F/STN.

BPCL
NAGARAM, R.R. DIST.
6019442707

ORIGINAL

19-JAN-2018 16:59:32

INVOICE NO: 290
VEHICLE NO: NOT ENTERED
NOZZLE NO: 4

PRODUCT: PETROL
RATE: 75.60 INR/Ltr
VOLUME: 6.61 Ltr
AMOUNT: 500.00 INR

S.T. No : 27430268741C
M.S.T. No: 27430268741V

Thank You! Visit Again

Pos : 4 User : 1 Bill : 00000123
 Date : 19/01/2018 Time : 13:27:07

Description	Qty	Rate	Amount
TINLEY WATE	8.000	12.00	96.00
HARRY BAG R	1.000	3.00	3.00
HSN @ GST : 220110 @ 18%			96.00
TOTAL RS :	2 / 9.000		99.00

Tendered-CASH RS 100.00
 Change -CASH RS 1.00

THANK YOU VISIT AGAIN
 GST AS APPLICABLE IS INCLUDED

NEHRU OUTER RING ROAD
BONGULUR TOLL PLAZA

Receipt No. : 00405 Emp. ID : P120PTR
 Date - Time : 08/Jan/2018 02:24:43 PM
 Vehicle No. : 2512
 Vehicle Type : CAR/JEEP/LMV
 Entry Plaza : GHATKESAR TOLL PLAZA
 Amount In Rs. : Rs. 40.00
 Plaza Distance : 27.35 Kms.

Wish you a happy journey

NEHRJ OUTER RING ROAD
KEESARA TOLL PLAZA

Receipt No. : 00292 Emp. ID : P80PTR2
 Date - Time : 08/Jan/2018 03:25:52 PM
 Vehicle No. : 2512
 Vehicle Type : CAR/JEEP/LMV
 Entry Plaza : BONGULUR TOLL PLAZA
 Amount In Rs. : Rs. 60.00
 Plaza Distance : 35.90 Kms.

Wish you a happy journey

SRINIVASA FILLING STATION
 PLOT NO. 242 & 243, Opp. Chakripuram,
 Kushaiguda, R.R. Dist., Hyderabad-52.
 Ph. No: 986609111, 97 63 362823

APGST No. HYR/2/3762/04-05
 CASH MEMO Ph : 64552226, 27133476
SRINIVASA FILLING STATION
 Plot No. 242 & 243, Opp. Chakripuram,
 Kushaiguda, R.R. Dist., Hyderabad-52.
 No. 11522 Date : 20/1/2018

Qty.	PARTICULARS	Rs.	Ps.
	Lts. PETROL 13	1000	
	2T OIL 10		
	Lts. Diesel		
	Lts. E. Oil		
	T.Q. Total	1000	

Veh. No. Sign.

INV. NO: 0007
 DATE: 09/01/2018 1:39
 GULMIL PARKER (F) ₹180.00
 ANNA VEG (F) ₹160.00
 MARCHURI (F) ₹280.00
 QTY : 2 @ ₹140.00 each
 ROTTI ₹120.00
 QTY : 8 @ ₹15.00 each
 MINERAL WATER ₹40.00
 QTY : 2 @ ₹20.00 each

TOTAL 14 QTY ₹750.00
 CASH ₹780.00
 CLEPH: 0014572

Gaethanjali College of Engg. Techn.
 Chevayal (V), Keesara (M), R.R. Dist. (A.P.) - 501 387

SSB RETAIL INDIA PRIVATE LIMITED
 PLOT NO 140/A, EASWARIPURI COLONY
 HT ROAD, SAINIKPURI, SEC-BAD
 Ph. NO: 7032999119
 GST - AVCS99637F12L

T.O.T. No. SEC/03/0/1165

INVOICE

Ph : 040-27895817
Cell : 9703979511



JAIPUR EMPORIUM



WHOLESALE & RETAIL

Rajasthani Handicraft, Brass Handicraft & Pooja Items
Shop No. 54, 1st Floor, Minerva Complex, S.D. Road, Secunderabad - 3.

No. 142

Date: 19/01/2018

M/s.

CASH BILL		Ph: 040-40203005	
BEST DIGITALS			
A0, A1, A2, Print Copy Scan, A3, A4, 12x18, 13x19 Photos, Project, Autocad Prints, Scanning, Internet, Lamination, Programme Cutting, Spiral Binding. Bhavani Shopping Complex ECIL X Roads, Hyd-62.			
Name.....		Date.....	
SI. No.	PARTICULARS	Qty.	Rate Rs.
①	13 n/a copy	100	1500/-
		TOTAL	1500/-
			Signature

PRINCIPAL
Geethanjali College of Engg. Tech.
Geethaji (V), Kooruru (M), K.R. Dist. (A.P.) - 501 307

SI. No.	PARTICULARS	RATE	AMOUNT
①	Brass Ganesha 1B	4500/-	4000.00
②	Brass Hanushana Tree	3700/-	3000.00
		TOTAL	7000.00

Goods once sold will not be taken back

For JAIPUR EMPORIUM

Prize winners



Project Expo. 3000

{ Ch. Mouica }
 N. Mouika Reddy } GLET
 M. Pradhyuma }

2. Shibom Kumar Paul }
 B. Hari Kumar } 2000
 N. Nausin } MITS - 

3. { A. Naven Kumar }
 B. Sri Sai Kalyan. } 1500
 D. Anopi Chandan. } GLET Kavela

Idea presentation

P. Carol Nayya - 1000 - CSE 2D - 16R11A05E5 
 K. V. Manikantan - 1000 - CSE - 10 - SB7. 
 T. Sai Teja Rao - 1000 - CSE - 1C - SD5 

 Prof. V. Chandrabathi
 Convener

 PRINCIPAL
 Geethanjali College of Engg. Tech.
 Chaeryal (V), Koppal, Dist. Chittoor, A.P. - 505 101

[Click here to enable desktop notifications for](#)

More

Gmail

COMPOSE

(no subject)

Inbox x

Inbox (13,818)

Starred

Important

Sent Mail

Drafts (72)

Categories



Chandra Nagulapalli
to Yvn, me

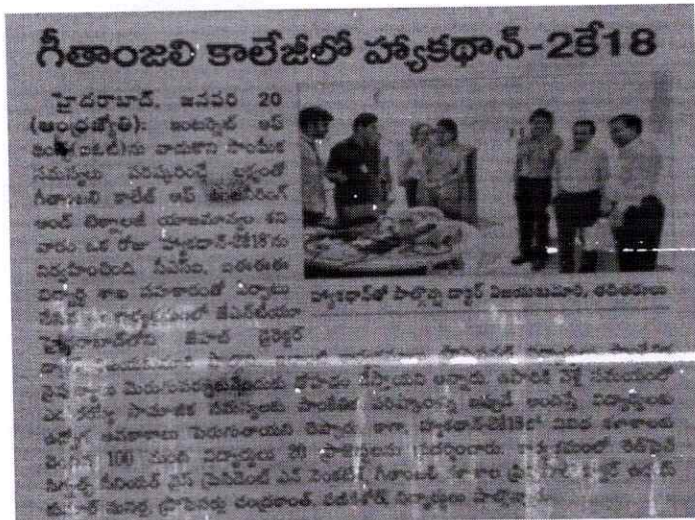

Sign in

Signing in will sign you into Hangouts across Google. Learn more

8

PRINCIPAL
 Geethanjali College of Engg. Tech.
 Cheerla (V), Kossuru (M), R.R. Dist. (A.P.) - 501 301



Geethanjali College of Engineering and Technology

(Autonomous)

CHEERYAL (V), KEESARA (M), Medchal DIST-501301, Telangana

Date: 20-01-2018

HACKATHON 2K18

Schedule for Valedictory Function:

Sl.No.	Event	Time	Duration
1	Introduction	3:00 – 3:05 PM	5 mins.
2	Invitation of guests to the dais and presentation of bouquet to the dignitaries	3:05 – 3:10 PM	5 mins.
	Program ^{re-duct} highlights by Convener	3:10 – 3:15 PM	5 mins.
3	Address by Principal Sir (GCET)	3:15-3:20 PM	5 mins.
4	Address by Secretary Sir (GCET)	3:20-3:25 PM	5 mins.
6	Keynote Address by Respected Chief Guest <name, design>	3:25 – 3:40 PM	15 mins
7	Presentation of Certificates	3:40 – 4:00 PM	20 Mins
8	Vote of thanks (compere)	4:00 – 4:05 PM	5 mins.
9	National Anthem and closing	4:05 PM	.

PRINCIPAL
Geethanjali College of Engg. Tech
Cheeryal (V), Keesara (M), R.R. Dist. (A.P.) - 501 301



Geethanjali College of Engineering and Technology

(Autonomous)

CHEERYAL (V), KEESARA (M), Medchal DIST-501301, Telangana

Date: 20/1/2018

HACKATHON 2K18

Schedule for Inaugural Function:

Sl.No.	Event	Time	Duration
1	Introduction	10:30 – 10:35 AM	5 mins.
2	Invitation of guests to the dais and presentation of bouquet to the dignitaries	10:35 - 10 :40 AM	5 mins.
3	Prayer and Lighting of the lamp	10:40-10:45 AM	5 mins.
4	Welcome Address by Principal Sir (GCET)	10:45 – 10:55 AM	10 mins.
5	Address by Secretary Sir (GCET)	10:55 – 11 :05 AM	10 mins.
7	Keynote Address by Respected Chief Guest Dr. Vijaya Kumari Garu	11:05 – 11:25 AM	20 mins
8	Vote of thanks (Anchor) <i>ck</i>	11:25 – 11:30 AM	5 mins.

ck
PRINCIPAL
Geethanjali College of Engg. Tech.
Cheeryal (V), Keesara (M), K.R. Dist. (A.P.) - 501 301



Geethanjali College of Engineering and Technology



INNOVANT
TECHNOCRAT CLUB

An UGC Autonomous Institution

Approved by AICTE, Permanently Affiliated to JNTUH, Accredited by NAAC with 'A' grade, & NBA (New Delhi)
Cheeryal(V), Keesara(M), Medchal Dist. 501301

HACKATHON - 2K18

This is to certify that Mr. / Ms. P. vishal vinay of

GCEET

has Participated in

Hackathon 2K18 held at Geethanjali College of Engineering and
Technology on 20th January, 2018.

PROF. N. CHANDRAKANTH
(CONVENER)

DR. UDAYA KUMAR SUSARLA
(CHAIRMAN)

Geethanjali College of Engg. Tech.
Cheeryal (V), Keesara (M), R.R. Dist. (A.P.) - 501301



Geethanjali College of Engineering and Technology

An UGC Autonomous Institution

Approved by AICTE, Permanently Affiliated to JNTUH, Accredited by NAAC with 'A' grade, & NBA (New Delhi) Cheerayal(V), Keesara(M), Medchal Dist. 501301



INNOVANT
TECHNOCRAT CLUB

HACKATHON - 2K18

This is to certify that Mr. / Ms. P. Krishna Sai of VBIT has Participated in Hackathon 2K18 held at Geethanjali College of Engineering and Technology on 20th January, 2018.

PROF. N. CHANDRAKANTH

DR. UDAYA KUMAR SUSARLA



Geethanjali College of Engineering and Technology

An UGC Autonomous Institution

Approved by AICTE, Permanently Affiliated to JNTUH, Accredited by NAAC with 'A' grade, & NBA (New Delhi) Cheerayal(V), Keesara(M), Medchal Dist. 501301



INNOVANT
TECHNOCRAT CLUB

HACKATHON - 2K18

This is to certify that Mr. / Ms. J. Pranay of VBZT has Participated in Hackathon 2K18 held at Geethanjali College of Engineering and Technology on 20th January, 2018.

PROF. N. CHANDRAKANTH

DR. UDAYA KUMAR SUSARLA



Geethanjali College of Engineering and Technology



An UGC Autonomous Institution
Approved by AICTE, Permanently Affiliated to JNTUH, Accredited by NAAC with 'A' grade, & NBA (New Delhi)
Cheerlyal(V), Keesara(M), Medchal Dist. 501301

HACKATHON - 2K18

CERTIFICATE OF MERIT

This is to certify that Mr. / Ms. CH · MOUNICA of
GCE T won First prize in Hackathon 2K18

held at Geethanjali College of Engineering and Technology

on 20th January, 2018.

PROF. N. CHANDRAKANTH
(CONVENER)

DR. UDAYA KUMAR SUSARLA
(PATRON)

Geethanjali College of Engineering and Technology,
Cheerlyal (V), Keesara (M), R.R. Dist. N.T.P. - 501 301



Geethanjali College of Engineering and Technology

An UGC Autonomous Institution

Approved by AICTE, Permanently Affiliated to JNTUH, Accredited by NAAC with 'A' grade, & NBA (New Delhi) Cheeryal(V), Keesara(M), Medchal Dist. 501301



INNOVANT
TECHNOCRAT CLUB

HACKATHON - 2K18

This is to certify that Mr. / Ms. N. Sai Kumar of HITS has Participated in Hackathon 2K18 held at Geethanjali College of Engineering and Technology on 20th January, 2018.

PRINCIPAL
Geethanjali College of Engg. Tech.
Cheeryal (V), Keesara (M), R.R. Dist. (A.P.) - 501301

PROF. N. CHANDRAKANTH

DR. UDAYA KUMAR SUSARLA



Geethanjali College of Engineering and Technology



An UGC Autonomous Institution

Approved by AICTE, Permanently Affiliated to JNTUH, Accredited by NAAC with 'A' grade, & NBA (New Delhi)
Cheeryal(V), Keesara(M), Medchal Dist. 501301

HACKATHON - 2K18

This is to certify that Mr. / Ms. M. PRADHYUMNA of GCET has Participated in

Hackathon 2K18 held at Geethanjali College of Engineering and Technology on 20th January, 2018.

Geethanjali College of Engineering and Technology
Cheeryal (V), Keesara (M), R.R. Dist. (A.P.) - 501301

PROF. N. CHANDRAKANTH

DR. UDAYA KUMAR SUSARLA



Geethanjali College of Engineering and Technology

An UGC Autonomous Institution

Approved by AICTE, Permanently Affiliated to JNTUH, Accredited by NAAC with 'A' grade, & NBA (New Delhi)
Cheerayal(V), Keesara(M), Medchal Dist. 501301



INNOVANT
TECHNOCRAT CLUB

HACKATHON - 2K18

This is to certify that Mr. / Ms. T. Bhanu Prakash of
HITS has Participated in
Hackathon 2K18 held at Geethanjali College of Engineering and
Technology on 20th January, 2018.

Geethanjali COLLEGE OF ENGINEERING
(Cheerayal(V), Keesara(M), Medchal Dist. (A.P.)-501301)

PROF. N. CHANDRAKANTH

DR. UDAYA KUMAR SUSARLA



Geethanjali College of Engineering and Technology

An UGC Autonomous Institution

Approved by AICTE, Permanently Affiliated to JNTUH, Accredited by NAAC with 'A' grade, & NBA (New Delhi) Cheeryal(V), Keesara(M), Medchal Dist. 501301



INNOVANT
TECHNOCRAT CLUB

HACKATHON - 2K18

This is to certify that Mr. / Ms. N. MOUNIKA of

GCEET has Participated in

Hackathon 2K18 held at Geethanjali College of Engineering and Technology on 20th January, 2018.

PROF. N. CHANDRAKANTH
(CONVENER)

DR. UDAYA KUMAR SUSARLA
(CHAIRMAN)



Geethanjali College of Engineering and Technology

An UGC Autonomous Institution

Approved by AICTE, Permanently Affiliated to JNTUH, Accredited by NAAC with 'A' grade, & NBA (New Delhi)
Cheeryal(V), Keesara(M), Medchal Dist. 501301



INNOVANT
TECHNOCRAT CLUB

HACKATHON - 2K18

This is to certify that Mr. / Ms. CH MOUNIKA of GCET has Participated in Hackathon 2K18 held at Geethanjali College of Engineering and Technology on 20th January, 2018.

PROF. N. CHANDRAKANTH

DR. UDAYA KUMAR SUSARLA



Geethanjali College of Engineering and Technology



An UGC Autonomous Institution
Approved by AICTE, Permanently Affiliated to JNTUH, Accredited by NAAC with 'A' grade, & NBA (New Delhi)
Cheerayal(V), Keesara(M), Medchal Dist. 501301

HACKATHON - 2K18

This is to certify that Mr. / Ms. PIYUSH BALAJI of

GCE

has Participated in
Hackathon 2K18 held at Geethanjali College of Engineering and
Technology on 20th January, 2018.

Geethanjali College of Engineering and Technology
Cheerayal (V), Keesara (M), R.R. Dist. (K.R.) - 501301

PROF. N. CHANDRAKANTH
(CONVENER)

DR. UDAYA KUMAR SUSARLA
(DATE)



Geethanjali College of Engineering and Technology

An UGC Autonomous Institution

Approved by AICTE, Permanently Affiliated to JNTUH, Accredited by NAAC with 'A' grade, & NBA (New Delhi) Cheeryal(V), Keesara(M), Medchal Dist. 501301



INNOVANT
TECHNOCRAT CLUB

HACKATHON - 2K18

This is to certify that Mr. / Ms. V. Ashok of

HITS has Participated in
Hackathon 2K18 held at Geethanjali College of Engineering and
Technology on 20th January, 2018.

PROF. N. CHANDRAKANTH
(CONVENOR)

DR. UDAYA KUMAR SUSARLA
(COORDINATOR)

FRONT PAGE
Geethanjali College of Engineering and Technology
Cheeryal (V), Keesara (M), R.R. Dist. (A.P.) - 501301

3/10/18

30pc

285—

**M.R. TRADER'S
ROSE BISCUITS AGENCIE**

Shop No. 315/3, H.B. Colony,
NFC Main Road, Moula-Ali,
Hyd-500 040. Cell: 9032158360



ASHOKA DIGITALS

Shop No.1, Opp. Sri Ratna Restaurant
Sri Chakripuram 'X' Roads, Kusaiguda, Hyd.
Cell : 9866478744, 7660000971
E-mail : ashokadigitals1.com

Estimation

No : 740

Date : 27/8/18

S.No	RATE	AMOUNT	
		Rs.	Ps.
	EX3-1w Reel	200	1
TOTAL		200	

Receiver's Signature

For ASHOKA DIGITALS

Vardhaman

CSE 3A

14R11A0505

9618122355

avsv.vardhaman

@gmail.com.

A.Y :2017-18

Geethanjali College of Engineering and Technology

Department of Computer Science & Engineering

Workshop on **Android Application Development** on 12th, 13th, and 14th August 2017.

RESOURCE PERSON: Mr.G. Durga Prasad, Trainer, NSIC,Hyderabad.

STUDENT'S FEEDBACK

(5-Excellent, 4-Very Good, 3-Good, 2-Satisfactory, 1-Unsatisfactory)

Audibility	Explanation	Practical Approach	Understanding Level	Overall Experience
3	3	4	3	3

Any Suggestions:

A.Y :2017-18

Geethanjali College of Engineering and Technology

Department of Computer Science & Engineering

Workshop on **Android Application Development** on 12th, 13th, and 14th August 2017.

RESOURCE PERSON: Mr.G. Durga Prasad, Trainer, NSIC, Hyderabad.

STUDENT'S FEEDBACK

(5-Excellent, 4-Very Good, 3-Good, 2-Satisfactory, 1-Unsatisfactory)

Audibility	Explanation	Practical Approach	Understanding Level	Overall Experience
5	4	5	4	5

Any Suggestions:

Workshop need to be conducted for more number of days and more trainees needed.

A.Y :2017-18

Geethanjali College of Engineering and Technology

Department of Computer Science & Engineering

Workshop on **Android Application Development** on 12th, 13th, and 14th August 2017.

RESOURCE PERSON: Mr.G. Durga Prasad, Trainer, NSIC, Hyderabad.

STUDENT'S FEEDBACK

(5-Excellent, 4-Very Good, 3-Good, 2-Satisfactory, 1-Unsatisfactory)

Audibility	Explanation	Practical Approach	Understanding Level	Overall Experience
5	4	4	5	4

Any Suggestions:

--

A.Y :2017-18

Geethanjali College of Engineering and Technology

Department of Computer Science & Engineering

Workshop on **Android Application Development** on 12th, 13th, and 14th August 2017.

RESOURCE PERSON: Mr.G. Durga Prasad, Trainer, NSIC, Hyderabad.

STUDENT'S FEEDBACK

(5-Excellent, 4-Very Good, 3-Good, 2-Satisfactory, 1-Unsatisfactory)

Audibility	Explanation	Practical Approach	Understanding Level	Overall Experience
5	4	5	5	4

Any Suggestions:

More trainers are required for better outcome and workshop is needed for some more days.

A.Y :2017-18

Geethanjali College of Engineering and Technology,
Department of Computer Science & Engineering

Workshop on **Android Application Development** on 12th, 13th, and 14th August 2017.

RESOURCE PERSON: Mr.G. Durga Prasad, Trainer, NSIC, Hyderabad.

STUDENT'S FEEDBACK

(5-Excellent, 4-Very Good, 3-Good, 2-Satisfactory, 1-Unsatisfactory)

Audibility	Explanation	Practical Approach	Understanding Level	Overall Experience
4	4	4	4	4

Any Suggestions:

A.Y :2017-18

Geethanjali College of Engineering and Technology

Department of Computer Science & Engineering

Workshop on **Android Application Development** on 12th, 13th, and 14th August 2017.

RESOURCE PERSON: Mr.G. Durga Prasad, Trainer, NSIC, Hyderabad.

STUDENT'S FEEDBACK

(5-Excellent, 4-Very Good, 3-Good, 2-Satisfactory, 1-Unsatisfactory)

Audibility	Explanation	Practical Approach	Understanding Level	Overall Experience
5	5	5	4	5

Any Suggestions:

None

A.Y : 2017-18

Geethanjali College of Engineering and Technology
Department of Computer Science & Engineering

Workshop on **Android Application Development** on 12th, 13th, and 14th August 2017.

RESOURCE PERSON: Mr.G. Durga Prasad, Trainer, NSIC ,Hyderabad.

STUDENT'S FEEDBACK

(5-Excellent, 4-Very Good, 3-Good, 2-Satisfactory, 1-Unsatisfactory)

Audibility	Explanation	Practical Approach	Understanding Level	Overall Experience
3	4	5	4	4

Any Suggestions:

None

A.Y :2017-18

Geethanjali College of Engineering and Technology

Department of Computer Science & Engineering

Workshop on **Android Application Development** on 12th, 13th, and 14th August 2017.

RESOURCE PERSON: Mr.G. Durga Prasad, Trainer, NSIC ,Hyderabad.

STUDENT'S FEEDBACK

(5-Excellent, 4-Very Good, 3-Good, 2-Satisfactory, 1-Unsatisfactory)

Audibility	Explanation	Practical Approach	Understanding Level	Overall Experience
4	4	5	4	4

Any Suggestions:

--

A.Y : 2017-18

Geethanjali College of Engineering and Technology,

Department of Computer Science & Engineering

Workshop on **Android Application Development** on 12th, 13th, and 14th August 2017.

RESOURCE PERSON: Mr.G. Durga Prasad, Trainer, NSIC, Hyderabad.

STUDENT'S FEEDBACK

(5-Excellent, 4-Very Good, 3-Good, 2-Satisfactory, 1-Unsatisfactory)

Audibility	Explanation	Practical Approach	Understanding Level	Overall Experience
3	4	4	4	4

Any Suggestions:

Nothing very best

A.Y :2017-18

Beechhanjali College of Engineering and Technology

Department of Computer Science & Engineering

Workshop on **Android Application Development** on 12th, 13th, and 14th August 2017.

RESOURCE PERSON: Mr.G. Durga Prasad, Trainer, NSIC, Hyderabad.

STUDENT'S FEEDBACK

(5-Excellent, 4-Very Good, 3-Good, 2-Satisfactory, 1-Unsatisfactory)

Audibility	Explanation	Practical Approach	Understanding Level	Overall Experience
4	5	5	5	4

Any Suggestions:

A.Y :2017-18

Geethanjali College of Engineering and Technology,

Department of Computer Science & Engineering

Workshop on **Android Application Development** on 12th, 13th, and 14th August 2017.

RESOURCE PERSON: Mr.G. Durga Prasad, Trainer, NSIC, Hyderabad.

STUDENT'S FEEDBACK

(5-Excellent, 4-Very Good, 3-Good, 2-Satisfactory, 1-Unsatisfactory)

Audibility	Explanation	Practical Approach	Understanding Level	Overall Experience
5	5	5	5	5

Any Suggestions:

A.Y :2017-18

Geethanjali College of Engineering and Technology

Department of Computer Science & Engineering

Workshop on **Android Application Development** on 12th, 13th, and 14th August 2017.

RESOURCE PERSON: Mr.G. Durga Prasad, Trainer, NSIC, Hyderabad.

STUDENT'S FEEDBACK

(5-Excellent, 4-Very Good, 3-Good, 2-Satisfactory, 1-Unsatisfactory)

Audibility	Explanation	Practical Approach	Understanding Level	Overall Experience
3	4	4	3	4

Any Suggestions:

A.Y :2017-18

Geethanjali College of Engineering and Technology

Department of Computer Science & Engineering

Workshop on **Android Application Development** on 12th, 13th, and 14th August 2017.

RESOURCE PERSON: Mr.G. Durga Prasad, Trainer, NSIC ,Hyderabad.

STUDENT'S FEEDBACK

(5-Excellent, 4-Very Good, 3-Good, 2-Satisfactory, 1-Unsatisfactory)

Audibility	Explanation	Practical Approach	Understanding Level	Overall Experience
5	5	5	5	5

Any Suggestions:

A.Y :2017-18

Geethanjali College of Engineering and Technology
Department of Computer Science & Engineering

Workshop on **Android Application Development** on 12th, 13th, and 14th August 2017.

RESOURCE PERSON: Mr.G. Durga Prasad, Trainer, NSIC, Hyderabad.

STUDENT'S FEEDBACK

(5-Excellent, 4-Very Good, 3-Good, 2-Satisfactory, 1-Unsatisfactory)

Audibility	Explanation	Practical Approach	Understanding Level	Overall Experience
5	4	3	3	4

Any Suggestions:

—

A.Y :2017-18

Geethanjali College of Engineering and Technology
Department of Computer Science & Engineering

Workshop on **Android Application Development** on 12th, 13th, and 14th August 2017.

RESOURCE PERSON: Mr.G. Durga Prasad, Trainer, NSIC ,Hyderabad.

STUDENT'S FEEDBACK

(5-Excellent, 4-Very Good, 3-Good, 2-Satisfactory, 1-Unsatisfactory)

Audibility	Explanation	Practical Approach	Understanding Level	Overall Experience
5	4	5	4	4

Any Suggestions:

--

A.Y :2017-18

Geethanjali College of Engineering and Technology

Department of Computer Science & Engineering

Workshop on **Android Application Development** on 12th, 13th, and 14th August 2017.

RESOURCE PERSON: Mr.G. Durga Prasad, Trainer, NSIC ,Hyderabad.

STUDENT'S FEEDBACK

(5-Excellent, 4-Very Good, 3-Good; 2-Satisfactory, 1-Unsatisfactory)

Audibility	Explanation	Practical Approach	Understanding Level	Overall Experience
5	5	4	4	5

Any Suggestions:

A.Y :2017-18

Geethanjali College of Engineering and Technology

Department of Computer Science & Engineering

Workshop on **Android Application Development** on 12th, 13th, and 14th August 2017.

RESOURCE PERSON: Mr.G. Durga Prasad, Trainer, NSIC, Hyderabad.

STUDENT'S FEEDBACK

(5-Excellent, 4-Very Good, 3-Good, 2-Satisfactory, 1-Unsatisfactory)

Audibility	Explanation	Practical Approach	Understanding Level	Overall Experience
4	4	3	4	4

Any Suggestions:

A.Y :2017-18

Geethanjali College of Engineering and Technology

Department of Computer Science & Engineering

Workshop on **Android Application Development** on 12th, 13th, and 14th August 2017.

RESOURCE PERSON: Mr.G. Durga Prasad, Trainer, NSIC ,Hyderabad.

STUDENT'S FEEDBACK

(5-Excellent, 4-Very Good, 3-Good, 2-Satisfactory, 1-Unsatisfactory)

Audibility	Explanation	Practical Approach	Understanding Level	Overall Experience
5	4	5	4	4

Any Suggestions:

--

A.Y :2017-18

Geethanjali College of Engineering and Technology

Department of Computer Science & Engineering

Workshop on **Android-Application Development** on 12th, 13th, and 14th August 2017.

RESOURCE PERSON: Mr.G. Durga Prasad, Trainer, NSIC ,Hyderabad.

STUDENT'S FEEDBACK

(5-Excellent, 4-Very Good, 3-Good, 2-Satisfactory, 1-Unsatisfactory)

Audibility	Explanation	Practical Approach	Understanding Level	Overall Experience
4	4	5	4	5

Any Suggestions:

A.Y :2017-18

Geethanjali College of Engineering and Technology

Department of Computer Science & Engineering

Workshop on **Android Application Development** on 12th, 13th, and 14th August 2017.

RESOURCE PERSON: Mr.G. Durga Prasad, Trainer, NSIC ,Hyderabad.

STUDENT'S FEEDBACK

(5-Excellent, 4-Very Good, 3-Good, 2-Satisfactory, 1-Unsatisfactory)

Audibility	Explanation	Practical Approach	Understanding Level	Overall Experience
5	5	3	3	4

Any Suggestions:

A.Y.:2017-18

Geethanjali College of Engineering and Technology

Department of Computer Science & Engineering

Workshop on **Android Application Development** on 12th, 13th, and 14th August 2017.

RESOURCE PERSON: Mr.G. Durga Prasad, Trainer, NSIC, Hyderabad.

STUDENT'S FEEDBACK

(5-Excellent, 4-Very Good, 3-Good, 2-Satisfactory, 1-Unsatisfactory)

Audibility	Explanation	Practical Approach	Understanding Level	Overall Experience
5	4	3	2	3

Any Suggestions:

The Introduction expired in a flash

A.Y :2017-18

Geethanjali College of Engineering and Technology

Department of Computer Science & Engineering

Workshop on **Android Application Development** on 12th, 13th, and 14th August 2017.

RESOURCE PERSON: Mr.G. Durga Prasad, Trainer, NSIC,Hyderabad.

STUDENT'S FEEDBACK

(5-Excellent, 4-Very Good, 3-Good, 2-Satisfactory, 1-Unsatisfactory)

Audibility	Explanation	Practical Approach	Understanding Level	Overall Experience
4	4	4	4	4

Any Suggestions:

--

A.Y :2017-18

Geethanjali College of Engineering and Technology

Department of Computer Science & Engineering

Workshop on **Android Application Development** on 12th, 13th, and 14th August 2017.

RESOURCE PERSON: Mr.G. Durga Prasad, Trainer, NSIC, Hyderabad.

STUDENT'S FEEDBACK

(5-Excellent, 4-Very Good, 3-Good, 2-Satisfactory, 1-Unsatisfactory)

Audibility	Explanation	Practical Approach	Understanding Level	Overall Experience
3	3	3	2	3

Any Suggestions:

--

A.Y :2017-18

Geethanjali College of Engineering and Technology

Department of Computer Science & Engineering

Workshop on **Android Application Development** on 12th, 13th, and 14th August 2017.

RESOURCE PERSON: Mr.G. Durga Prasad, Trainer, NSIC, Hyderabad.

STUDENT'S FEEDBACK

(5-Excellent, 4-Very Good, 3-Good, 2-Satisfactory, 1-Unsatisfactory)

Audibility	Explanation	Practical Approach	Understanding Level	Overall Experience
5	5	4	4	4

Any Suggestions:

A.Y :2017-18

Geethanjali College of Engineering and Technology

Department of Computer Science & Engineering

Workshop on **Android-Application Development** on 12th, 13th, and 14th August 2017.

RESOURCE PERSON: Mr.G. Durga Prasad, Trainer, NSIC,Hyderabad.

STUDENT'S FEEDBACK

(5-Excellent, 4-Very Good, 3-Good, 2-Satisfactory, 1-Unsatisfactory)

Audibility	Explanation	Practical Approach	Understanding Level	Overall Experience
	3	5	3	4

Any Suggestions:

--

Signature

A

8002

TOTAL

8002

1

Geethanjali College of Engineering & Technology
Cheerthala (V), Keerthi (M), R.R. Dist. (A.P.) - 501 301
Principal

✓
Dhas 8x4

SI. No. PARTICULARS Qty. Rate Rs. Amount ps.

M/S: Geethanjali College
Date: 03/11/17
No. 2817

NAVEEN ARTS

Shop No. 13, Epsilon Towers, ECIL 'X' Roads, Hyderabad - 62.

Ph : 9396501017 BILL

CHINA BAZAR

S.No. 13, NMDC Colony, East Anand Bagh, Malkajgiri, Hyd. Cell : 8686542790

Toys • Gifts • Novelty • Baby Items • School Bags • Ladies Purse

Crockery Items • Steel Items • All Kinds of Plastic Goods & Home Needs

No.

M/s.....Date 26-09-18

No.	PARTICULARS	Qty.	Rate	Amount
1	Partition Box	1	195	195 -
2	T/R Box	1	80	80 -
3				
4				
5				
6				
7				
8				
9				
10				
11				
12				
13				
14				
15				
16				
17				
18				
19				
20				

PRINCIPAL
Geethanjali College of Engg. Tech.
Cheerhal (V), Kothuru (M), R.R. Dist. (A.P.) - 501 304

Rs 275 -

Signature.

DATE • NO GUARANTEE • NO RETURN

Geethanjali College of Engineering and Technology

AUTONOMOUS

(Approved by AICTE, New Delhi, Permanently Affiliated to JNTUH Hyderabad)
Cheerlax, Keesara(M), Medchal Dist. Ph : 9014241618, 9533791618

No. **2018**

RECEIPT

Date: 03/10/18

Received with thanks from

Students cse/ECE/civ/2-II/11/17/18

a sum of Rs. 1,05,000/-

in words (Rupees one lakh fifty thousand)

As per student list collected

by Cash / Cheque No. _____

towards Workshop [SkyFi Labs] Registration fee.

For Geethanjali College of Engg. & Tech.

Authorised Signatory



राष्ट्रीय लघु उद्योग निगम लिमिटेड
The National Small Industries Corporation Ltd.

TSC

(A Government of India Enterprise)

Technical Services Centre,

Kamalanagar, ECIL Post, Kushaiguda, Hyderabad - 500 062.

BANK RECEIPT

Receipt No. BR/ **7254**

To M/S./Mr./Ms. M/s. Geethanjali

Engineering College,
Chengal Keesara

V.R. No.					
	DAY	MONTH	YEAR		
DATE	16	08	17		

Received with thanks a sum of Rupees

Eight Hundred only (500/-)

Twenty Eight Thousand

by Cash / Cheque / D.D. No

101390

Dt

10/08/2017

Drawn On

SBI

towards

Admission for 10th

Rs. 24,400/-

Service Tax Payable Rs.

4399/-

Cheque (s) is / are subject to realisation)

Rs. 28,800/-

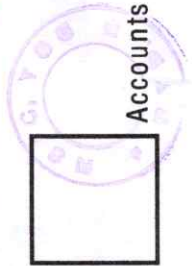

cashier

Accounts Officer

Officer

Chief Manager (Accts)

PRINCIPAL
Geethanjali College of Engg. Tech
Chengal (V), Keesara (M), R.R. Dist. (A.P.) - 50

For The NSIC LTD., TSC

[Signature]

Geethanjali College of Engineering and Technology

AUTONOMOUS

(Approved by AICTE, New Delhi, Permanently Affiliated to JNTUH Hyderabad)
Cheeryal, Keesara(M), Medchal Dist. Ph : 9014241618, 9533791618

1077

RECEIPT

Date: 10/08/2017

No.

Received with thanks from Prof. N. Chandrakanth (SE)
a sum of Rs. 28,800/- in words (Rupees Twenty eight Thousand
Eight hundred only)

_____ by Cash / Cheque No. _____

towards paid for Android development Workshop

For Geethanjali College of Engg. & Tech.

Authorised Signatory